



Controlled Environment
Agriculture & Hydroponics

Catalog
2022



Leader in Green Industry Distribution

BFG is truly your single source supplier!

Grower

Lawn and
Garden

CEA and
Hydro

Plants and
Seeds

About BFG Supply Co

Founded in 1972, BFG Supply has a long history of serving the Green Industry including professional growers, lawn & garden centers, landscapers, and indoor growing stores. As an established industry leader, BFG provides the highest levels of customer service, the broadest product range, and innovative technology solutions. BFG is a true single source supplier for all of your Green Industry needs from watering tools and control solutions to multi-acre fully integrated professional greenhouse structures.

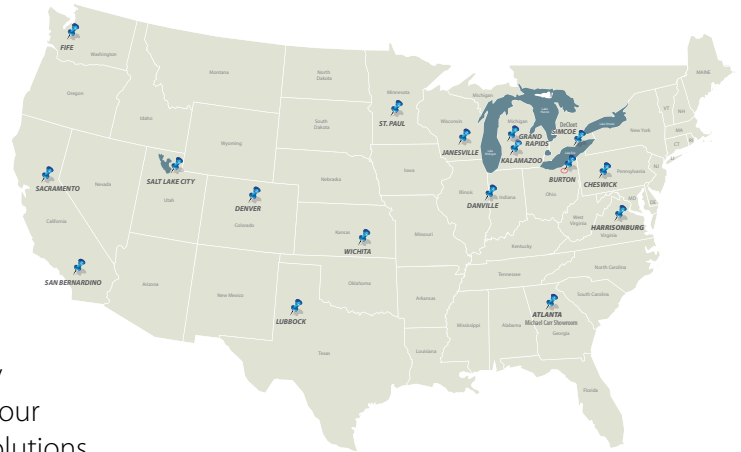

In a world full of change you can take comfort in knowing that BFG Supply is focused on caring for your business needs. We look forward to providing the best customer service in the industry and supporting the growth of our customers.

- In business for 50+ years with Industry leading customer service
- Focus on the Professional Grower, Independent Lawn & Garden, Controlled Environment Agriculture and Hydroponic industries
- Professional field sales force dedicated to customer success
- Broad product selection with 15,000+ skus in stock and 100,000+ skus available to order
- Seventeen modern distribution facilities to efficiently serve customers
- Leading technology to improve ordering and delivery efficiency

Today

BFG Supply Co. is the best it has ever been and continues to grow with a strong vision for the future.

We look forward
to helping
grow
your business



Table of
CONTENTS

Introduction	1-16
Growing Media	17-38
Nutrients & Additives	39-112
Insect & Disease Control.....	113-136
Containers.....	137-158
Plant Supports.....	159-164
Meters & Testers	165-174
Lighting	175-188
Irrigation	189-214
Equipment	215-254
Harvest & Storage.....	255-262
Coverings.....	263-272
Greenhouse Systems	273-296
Index.....	297-312

BROWSE BFG SUPPLY'S

vast product assortment
BFG offers more than just CEA/Hydro items!



**TO BROWSE ALL ADDITIONAL
CATEGORIES AND ITEMS AVAILABLE**

please see our full catalog lineup or
visit www.bfgsupply.com today!

SCAN NOW



Categories

Horticultural Supplies
Lawn & Garden
CEA / Hydroponics
Plants
Seeds

Catalogs

Lawn & Garden
Horticultural Supplies
CEA/Hydroponics
Wetsel Seed Reference Guide
The Plant Connection Spring Trials
Michael Carr Designs
Grower/Gardener Select
Turf & Landscaping Supplies
Greenhouse Structures

Grower

Lawn and
Garden

CEA and
Hydro

Plants and
Seeds



wide variety

BFG SUPPLY CO.

Exclusive Brands

Profitable "stand alone" high quality product lines offered exclusively by BFG Supply Co.!



Gardener  **Select**

Quality gardening products at an affordable price!

Products include bird baths, planters, watering cans, and more

Grower  **Select**

All the products you need to keep growing!

Products include fertilizer, containers, growing media, benching, and more.



Setting the hottest new trends!

Resin, statuary, indoor & outdoor pottery, Liconfiber and more



Custom blends for all!

Products include seed packet assortments, bulk garden seed, turf, forage, wildlife, and more.



New varieties are available every year!

Colorful combinations & eye-catching displays along with exciting new colors



Keep your feathered friends coming back all year!

Great quality feeders, suet, nectar, and more at affordable prices.



99.9% weed free and disease-resistant!

Blends that feature WaterGard QS enhanced w/Quickstart Micro Nutrients



Greenhouse structures for both retail & grower!

Talk to our experts about benching, irrigation, coverings, and more.

Exclusive Brands



For your current pricing and availability please scan the item using our mobile app, give us a call or visit our website: www.bfgsupply.com

Autopot™ 4 Pot System

The 4Pot System is extremely versatile and can be used for a wide range of plant types and sizes. Seasonal flowering plants and perennial shrubs thrive and produce an abundance of blooms and foliage because of the unique action of the AQUAvalve5™, which is designed to allow the plant to go through a wet & dry cycle.



12.4gal Reservoir

AUPAPWS001

UPC 818997010007

Min Buy 1 EA



BARCODE *Tips & Tricks*

Having issues reading barcodes? Due to the large amount of products in this catalog it is possible barcodes may read incorrectly. Isolate the intended barcode with paper before scanning.

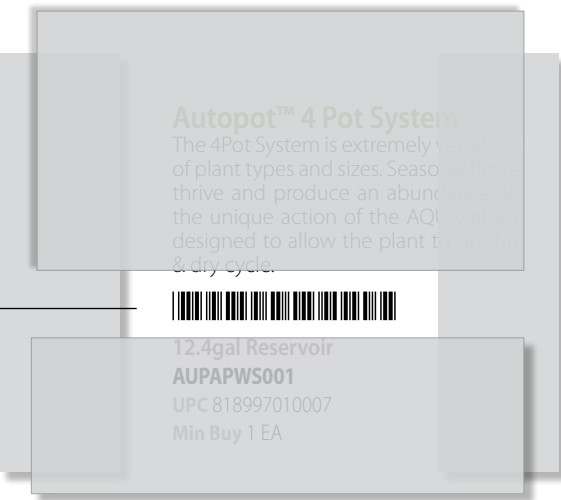

RELATIONSHIP TO ACCOUNT APPLICATION

These Terms and Conditions together with the Account Application and any fully executed Agreements between the parties contain the entire understanding between the parties as to all matters referred to herein. No other representations, covenants, undertakings or prior or contemporaneous agreements, whether oral or written, regarding any matters that are not specifically contained and incorporated in this Agreement, shall be deemed to have any effect or binding impact upon the parties. The language of this Agreement shall be construed according to its fair meaning and in accordance with its purpose and without regard to whom may have drafted any particular provision herein. For purposes of these Terms and Conditions "Customer" shall mean the legal entity that is a part to any BFG Supply Co. Account Application, or any Order placed with BFG Supply Co. and "Guarantor" shall mean any individual that executes the BFG Supply Co. Account Application as a guarantor.

ACCOUNT APPLICATION

Payment terms are stated on your invoice. Discounts may be offered on certain products in certain situations and will be specified on the invoice. These discounts, if offered, are only available on invoices paid and received into the BFG office within the terms outlined on your invoice via cash or check and payments via credit card are not eligible for discounts. Buyer is responsible for mail time and discounts are only available if BFG actually receives eligible payments during the time frame set forth in these Terms and Conditions. Post marks will not be considered. A finance charge of 2% per month (24% annually) will be assessed on invoices not paid within invoice term date. Payments received towards balance will first be applied to finance charges unless otherwise stated in writing by BFG. BFG reserves the right to assess the maximum amount of finance charges permitted by applicable law. BFG has the absolute discretion to place an account on C.O.D. status until past due balances, including finance charges, are satisfied in full and BFG has determined that Buyer is eligible for the reestablishment of a credit line in BFG's sole discretion. Any failure of the Buyer to satisfy any of its obligations under a Account Application with BFG, including but not limited to the failure to satisfy amounts due within payment terms shall comprise an event of default. In the event of default, if BFG must employ a collection agency or attorney to collect any past due account, Buyer shall be responsible for the satisfaction of all amounts incurred in collection of any past due account including collection costs and attorney fees.

PAYMENTS

Visa, MasterCard, Discover and American Express are acceptable payments at the time of purchase up to \$10,000 or higher as approved by BFG. Payments made after a finalized sale that require (or per request) a change in terms will be charged a 3% convenience fee. Please call BFG Accounts Receivable department at 800-883-0234 Ext 4997. Mail payments by check to BFG Supply Co., 3874 Solutions Center, Chicago, IL 60677-3008. All return checks are subject to a \$35 NSF fee.

ACCOUNT APPLICATION AND TAX EXEMPT FORMS

Account can be established by submitting a completed BFG Supply Co. Account Application. Allow three to four weeks for complete processing. In addition, a tax-exempt form for your state must be on file with BFG or taxes will be charged on all purchases. The Account Application must be completed in its entirety to avoid processing delays. Failure to provide all information will result in adverse action with respect to Buyer's application for credit, including declining the application.

INVOICES/STATEMENTS

Product will be invoiced on the date product is shipped from BFG or when delivery information is received from a manufacturer shipping direct. BFG will make good faith efforts to transmit monthly Account Statements at the beginning of each calendar month. Account Statements are reminders of open invoices, however, Account Statements do not grant an additional amount of time to remit payment. Please follow the terms indicated on your individual invoice. Copies of invoices can be located at www.bfgsupply.com or contact

BFG at 800- 883-0234. All these documents may be mailed, faxed, or e-mailed. Please contact BFG Supply Co., LLC or visit www.bfgsupply.com with your choice preference.

RETURNS

Our merchandise is sold on an outright sale basis and is not subject to return unless mis-shipped, damaged or defective. Any shipments refused for reasons other than freight damage will be subject to freight charges both ways as well as a restocking charge. If merchandise is mis-shipped, please contact our office for return authorization. We will arrange return transport and credit.

DAMAGE/SHORTAGE/DEFECTIVE ITEMS CLAIMS

Damage in shipment claims on items shipped via Fed-Ex/UPS/etc., must be made within one (1) business day (24 hours) of receipt of the merchandise. All claims for shortages and defective items must be reported to us within one (1) business day (24 hours) of delivery. All claims regarding billing errors, (pricing, terms, etc.) must be reported to BFG Supply or our representative within 30 days of delivery. Immediately upon receipt of truck shipments, examine the shipment carefully before signing the freight bill. If damage or shortage is evident, do not accept shipment without notation on the freight bill by the driver. Failure to do so may prevent you from filing a claim with the carrier. If you need assistance regarding damage claims, please contact your nearest BFG service location. A photograph of damaged product needs to be included with any damage claim. Merchandise found to be defective will be picked up (or field destroyed if you are advised to do so) and full credit will be issued provided the merchandise does not look like it has been abused or misused and is in accordance with the manufacturer's warranty policy. BFG Supply is not liable for damages, injuries or loss of revenue as a result of a manufacturer's defective item.

DELIVERIES

BFG delivers to customers in designated delivery areas according to an established daily routing schedule. Although we do our best to run the same routes on the same days each week, unavoidable circumstances may arise which prevent us from adhering to our normal schedule. Please note that we will do our best to make sure you receive the product you need when you need it. BFG delivery charges vary by location. Please contact your local BFG service center for pricing. Or ask your Sales Representative or Customer Service Rep for current delivery charges. Backorders may be subject to delivery charge. Delivery via BFG vehicles or trucks is subject to the equipment available at the BFG Service Center and the ease of access to the destination. Please contact your delivering service center for details. Some orders may be shipped via Fed-Ex/UPS/ Etc. at the buyer's expense and are subject to an additional order handling charge. Deliveries outside of our designated area may not ship via BFG and additional freight charges may apply. Please check with the local BFG location for complete details. Please note: all flower and vegetable seed for plant growers are shipped from our Harrisonburg Facility. No orders may be shipped via UPS for a C.O.D. purchase. These orders must be prepaid. Advanced payment arrangements must be made with your local BFG Service Center for all BFG truck deliveries. BFG drivers do not carry cash. Important: All orders for delivery via BFG tractor-trailer must be phoned or faxed in at least 48 hours prior to your scheduled delivery day. BFG will accept "add-on" orders before 10:00 a.m. on the business day prior to your scheduled delivery day but cannot guarantee that they will fit on the trailer. It is necessary that the customer has appropriate personnel present to assist our drivers in unloading.

WILL CALLS

Customers who wish to pick up merchandise from our warehouses are most welcome to do so. However, merchandise is not available in all locations; please call to verify if item is stocked. To help expedite your order, please call your order in ahead. Orders for pick up in the morning should be called into the office by 5:00 p.m. the day before. You may pick up items between 8:00 am-4:30 pm.

Continued on page 2





ACCOUNT APPLICATION

ACCOUNT #
SALES REPRESENTATIVE
APPROVED CREDIT LIMIT

OFFICE USE ONLY

COMPANY INFORMATION

COMPLETE LEGAL NAME *BFG Supply Co., LLC is a wholesale distributor and does not sell to individuals.		DBA / PARENT COMPANY (IF DIVISION OF OR OWNED BY ANOTHER COMPANY)		
BILLING ADDRESS		CITY	STATE	ZIP
SHIPPING ADDRESS		CITY	STATE	ZIP
COUNTY	BUSINESS PHONE#	BUSINESS FAX#	E-MAIL ADDRESS	
STORE HOURS		RECEIVING HOURS	RECEIVING CONTACT	
TYPE OF BUSINESS: <input type="checkbox"/> Corporation <input type="checkbox"/> Partnership <input type="checkbox"/> LLC <input type="checkbox"/> Sole Proprietor - <small>Must provide a current Schedule C of tax return.</small>		STATE OF INCORPORATION	FEDERAL ID#	
BUSINESS EST. DATE	YEARS UNDER CURRENT OWNER	DO YOU OWN THIS BUSINESS PROPERTY? IF NOT, WHO DOES?		TAX EXEMPT? <input type="checkbox"/> Yes <input type="checkbox"/> No If YES, PLEASE ATTACH CERTIFICATE.

By completing the Account Application the applicant affirms and certifies that the information provided is true and correct.

TYPE OF BUSINESS: PLEASE CHECK ALL THAT APPLY				
OPEN: <input type="checkbox"/> ALL YEAR	<input type="checkbox"/> SEASONAL	<input type="checkbox"/> OTHER (Please explain) _____		
<input type="checkbox"/> Landscaping	<input type="checkbox"/> Hydroponics	<input type="checkbox"/> Retail/Garden Center	<input type="checkbox"/> Grower	<input type="checkbox"/> Cannabis Production (Please include pdf of license and license #) _____
Order Preferences:				
Backorders OK? <input type="checkbox"/> Yes <input type="checkbox"/> No	Substitutions OK? <input type="checkbox"/> Yes <input type="checkbox"/> No	P.O. Required? <input type="checkbox"/> Yes <input type="checkbox"/> No	Pricing on Pick Tickets? <input type="checkbox"/> Yes <input type="checkbox"/> No	
Lift Gate Required? <input type="checkbox"/> Yes <input type="checkbox"/> No	Fork Lift Available? <input type="checkbox"/> Yes <input type="checkbox"/> No	Loading Dock? <input type="checkbox"/> Yes <input type="checkbox"/> No	Appointment Needed? <input type="checkbox"/> Yes <input type="checkbox"/> No	

OWNERS/OFFICERS/PARTNER INFORMATION (NOTE: Copy of Driver's License is required for Sole Proprietor Applying for Credit)

NAME #1	Title	NAME #2	Title
SSN#	% OWNED	SSN#	% OWNED
MOBILE	ALT. PHONE #	MOBILE	ALT. PHONE #
ADDRESS (if different from above)		ADDRESS (if different from above)	
CITY	STATE	ZIP	CITY
			STATE
			ZIP

DOCUMENT PREFERENCES - please choose how you would like the following documents to be delivered to you

ACKNOWLEDGMENTS	<input type="checkbox"/> E-MAIL:	<input type="checkbox"/> FAX:	<input type="checkbox"/> U.S. MAIL:
INVOICE/CREDITS	<input type="checkbox"/> E-MAIL:	<input type="checkbox"/> FAX:	<input type="checkbox"/> U.S. MAIL:
STATEMENTS	<input type="checkbox"/> E-MAIL:	<input type="checkbox"/> FAX:	<input type="checkbox"/> U.S. MAIL:

WOULD YOU LIKE TO APPLY FOR A LINE OF CREDIT WITH BFG SUPPLY?

NO - I want to prepay for my orders
 *Please sign terms and conditions page

YES - Please complete references. Credit Limit Desired \$ _____
 *Please sign both the terms and conditions and declaration page

BUSINESS CHECKING ACCOUNT REFERENCES

BANK NAME	ACCOUNT NUMBER	CONTACT PERSON	BANK PHONE NUMBER
-----------	----------------	----------------	-------------------

BUSINESS TRADE REFERENCES (include horticulture companies, if possible) - only complete if applying for credit

COMPANY NAME	ACCOUNT #	TELEPHONE #	FAX #	EMAIL

BFG SUPPLY CO.

Vendor Resources

Browse the next few pages for technical grow information on indoor grow operations.

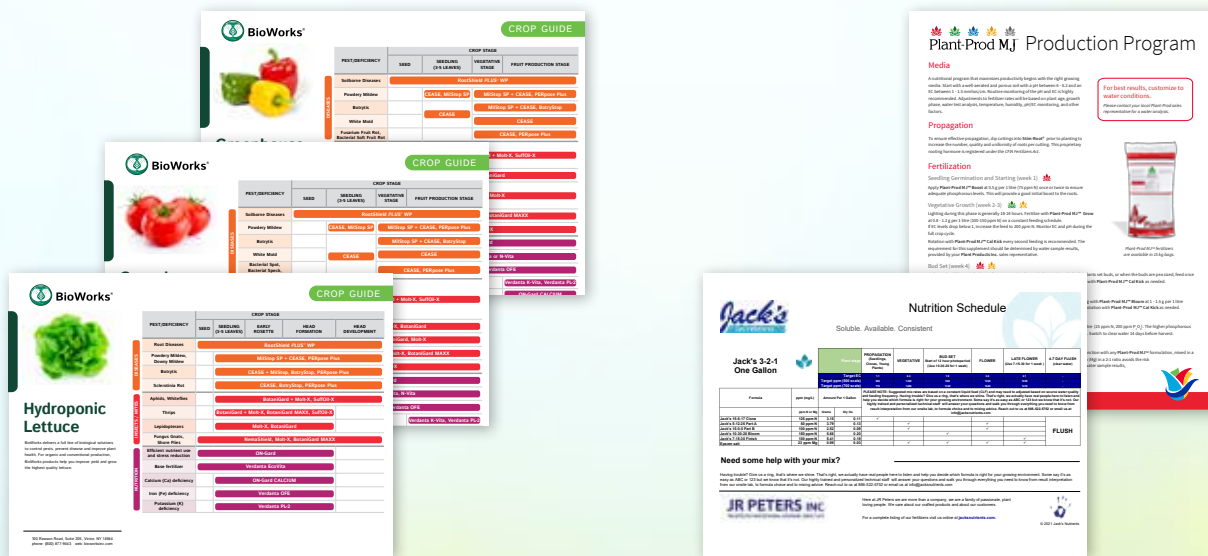

Crop Guides

Resourceful guides pointing you in the right direction for your crops!

Fertilizer Programs

Helpful guides to walk you through some of the top fertilizer programs!



BioWorks®



Hydroponic Lettuce

BioWorks delivers a full line of biological solutions to control pests, prevent disease and improve plant health. For organic and conventional production, BioWorks products help you improve yield and grow the highest quality lettuce.

CROP GUIDE

PEST/DEFICIENCY	CROP STAGE				
	SEED	SEEDLING (3-5 LEAVES)	EARLY ROSETTE	HEAD FORMATION	HEAD DEVELOPMENT
Root Diseases	RootShield PLUS+ WP				
Powdery Mildew, Downy Mildew	MiIStop SP + CEASE, PERpose Plus				
Botrytis	CEASE + MiIStop, BotryStop, PERpose Plus				
Sclerotinia Rot	CEASE, BotryStop, PERpose Plus				
Aphids, Whiteflies	BotaniGard + Molt-X, SuffOil-X				
Thrips	BotaniGard + Molt-X, BotaniGard MAXX, SuffOil-X				
Lepidopterans	Molt-X, BotaniGard				
Fungus Gnats, Shore Flies	NemaShield, Molt-X, BotaniGard MAXX				
Efficient nutrient use and stress reduction	ON-Gard				
Base fertilizer	Verdanta EcoVita				
Calcium (Ca) deficiency	ON-Gard CALCIUM				
Iron (Fe) deficiency	Verdanta OFE				
Potassium (K) deficiency	Verdanta PL-2				

DISEASES

INSECTS / MITES

NUTRITION



BioWorks®



Greenhouse Tomatoes

BioWorks delivers a full line of biological solutions to control pests, prevent disease and improve plant health. For organic and conventional production, BioWorks products help you improve yield and grow the highest quality tomatoes.

100 Rawson Road, Suite 205, Victor, NY 14564
phone: (800) 877-9443 web: bioworksinc.com

CROP GUIDE

PEST/DEFICIENCY	CROP STAGE			FRUIT PRODUCTION STAGE
	SEED	SEEDLING (3-5 LEAVES)	VEGETATIVE STAGE	
Soilborne Diseases	RootShield PLUS ⁺ WP			
Powdery Mildew		CEASE, MiIStop SP	MiIStop SP + CEASE, PERpose Plus	
Botrytis			MiIStop SP + CEASE, BotryStop	
White Mold		CEASE	CEASE	
Bacterial Spot, Bacterial Speck, Early Blight			CEASE, PERpose Plus	
Aphids, Whiteflies				
Thrips			BotaniGard + Molt-X, SuffOil-X	
Tomato Psyllid				
Lepidopterans			Molt-X, BotaniGard	
Tarnished Plant Bugs			BotaniGard, Molt-X	
Fungus Gnats, Shore Flies	NemaShield		NemaShield, Molt-X, BotaniGard MAXX	
Spider And Carmine Mites, Broad Mites			SuffOil-X	
Efficient nutrient use and stress reduction			ON-Gard	
Base fertilization or top dressing			Verdanta EcoVita, N-Vita	
Iron (Fe) deficiency			Verdanta OFE	
Potassium (K) deficiency			Verdanta K-Vita, Verdanta PL-2	
Calcium (Ca) deficiency			ON-Gard CALCIUM	

DISEASES

INSECTS / MITES

NUTRITION



BioWorks®



Greenhouse Peppers

BioWorks delivers a full line of biological solutions to control pests, prevent disease and improve plant health. For organic and conventional production, BioWorks products help you improve yield and grow the highest quality peppers.

100 Rawson Road, Suite 205, Victor, NY 14564
 phone: (800) 877-9443 web: bioworksinc.com

CROP GUIDE

PEST/DEFICIENCY	CROP STAGE		
	SEED	SEEDLING (3-5 LEAVES)	VEGETATIVE STAGE
DISEASES			
Soilborne Diseases	RootShield PLUS+ WP		
Powdery Mildew		CEASE, MilStop SP	MilStop SP + CEASE, PERpose Plus
Botrytis		CEASE	MilStop SP + CEASE, BotryStop
White Mold			CEASE
Fusarium Fruit Rot, Bacterial Soft Fruit Rot			CEASE, PERpose Plus
INSECTS / MITES			
Aphids, Whiteflies			BotaniGard + Molt-X, SuffOil-X
Thrips			
Lepidopterans			Molt-X, BotaniGard
Pepper Weevils			BotaniGard, Molt-X
Tarnished Plant Bugs			
Fungus Gnats, Shore Flies			NemaShield, Molt-X, BotaniGard MAXX
Spider Mites, Broad Mites			SuffOil-X
NUTRITION			
Efficient nutrient use and stress reduction			ON-Gard
Base fertilization or top dressing			Verdanta EcoVita or N-Vita
Iron (Fe) deficiency			Verdanta OFE
Potassium (K) deficiency			Verdanta K-Vita, Verdanta PL-2
Calcium (Ca) deficiency			ON-Gard CALCIUM



Nutrition Schedule

Soluble. Available. Consistent



Jack's 3-2-1 One Gallon

Plant stage	PROPAGATION (Seedlings, Clones, Young Plants)	VEGETATIVE	BUD SET Start of 12 hour photoperiod (Use 10-30-20 for 1 week)	FLOWER	LATE FLOWER (Use 7-15-30 for 1 week)	4-7 DAY FLUSH (clear water)
	1.1	2.4	1.9	2.4	2.1	-
	550	1200	950	1200	1050	-
	770	1680	1330	1680	1470	-

PLEASE NOTE: Suggested mix rates are based on a constant liquid feed (CLF) and may need to be adjusted based on source water quality and feeding frequency. Having trouble? Give us a ring, that's where we shine. That's right, we actually have real people here to listen and help you decide which formula is right for your growing environment. Some say it's as easy as ABC or 123 but we know that it's not. Our highly trained and personalized technical staff will answer your questions and walk you through everything you need to know from result interpretation from our onsite lab, to formula choice and to mixing advice. Reach out to us at 866-522-5752 or email us at info@jacksnutrients.com

Formula	ppm (mg/L)	Amount Per 1 Gallon	
		Grams	Dry Oz.
Jack's 15-6-17 Clone	125 ppm N	3.15	0.11
Jack's 5-12-26 Part A	50 ppm N	3.79	0.13
Jack's 15-0-0 Part B	100 ppm N	2.52	0.09
Jack's 10-30-20 Bloom	150 ppm N	5.68	0.20
Jack's 7-15-30 Finish	100 ppm N	5.41	0.19
Epsom salt	23 ppm Mg	0.99	0.03

Need some help with your mix?

Having trouble? Give us a ring, that's where we shine. That's right, we actually have real people here to listen and help you decide which formula is right for your growing environment. Some say it's as easy as ABC or 123 but we know that it's not. Our highly trained and personalized technical staff will answer your questions and walk you through everything you need to know from result interpretation from our onsite lab, to formula choice and to mixing advice. Reach out to us at 866-522-5752 or email us at info@jacksnutrients.com

JR PETERS INC
TRUSTED BY PROFESSIONAL GROWERS SINCE 1947



Here at JR Peters we are more than a company, we are a family of passionate, plant loving people. We care about our crafted products and about our customers.

For a complete listing of our fertilizers visit us online at jacksnutrients.com.

Media

A nutritional program that maximizes productivity begins with the right growing media. Start with a well-aerated and porous soil with a pH between 6 - 6.2 and an EC between 1 - 1.5 mmhos/cm. Routine monitoring of the pH and EC is highly recommended. Adjustments to fertilizer rates will be based on plant age, growth phase, water test analysis, temperature, humidity, pH/EC monitoring, and other factors.

For best results, customize to water conditions.

Please contact your local Plant-Prod sales representative for a water analysis.

Propagation

To ensure effective propagation, dip cuttings into **Stim-Root®** prior to planting to increase the number, quality and uniformity of roots per cutting. This proprietary rooting hormone is registered under the *CFIA Fertilizers Act*.

Fertilization

Seedling Germination and Starting (week 1)

Apply **Plant-Prod MJ™ Boost** at 0.5 g per 1 litre (75 ppm N) once or twice to ensure adequate phosphorous levels. This will provide a good initial boost to the roots.

Vegetative Growth (week 2-3)

Lighting during this phase is generally 18-24 hours. Fertilize with **Plant-Prod MJ™ Grow** at 0.8 - 1.2 g per 1 litre (100-150 ppm N) on a constant feeding schedule.

If EC levels drop below 1, increase the feed to 200 ppm N. Monitor EC and pH during the full crop cycle.

Rotation with **Plant-Prod MJ™ Cal Kick** every second feeding is recommended. The requirement for this supplement should be determined by water sample results, provided by your **Plant Products Inc.** sales representative.

Bud Set (week 4)

Lighting should be switched to 12 hours on, and 12 hours dark. In order to help the plants set buds, or when the buds are pea sized, feed once or twice with **Plant-Prod MJ™ Boost** at 1 g per 1 litre (150 ppm N). Continue rotation with **Plant-Prod MJ™ Cal Kick** as needed.

Bud Sizing (week 5-10)

Lighting should continue at 12 hours on, and 12 hours dark. Begin continuous feeding with **Plant-Prod MJ™ Bloom** at 1 - 1.5 g per 1 litre (100-150 ppm N). This will encourage full bud set and enhance bud filling. Continue rotation with **Plant-Prod MJ™ Cal Kick** as needed.

Finishing (week 11-14)

Plant-Prod MJ™ Finisher will help with plant finishing when applied at 0.65 g per 1 litre (25 ppm N, 200 ppm P₂O₅). The higher phosphorous and potassium will benefit the plants in their reproductive stage through to finishing. Switch to clear water 14 days before harvest.

Any Stage (week 1-14)

Plant-Prod MJ™ Spike (CaMg) can be used throughout the production cycle in conjunction with any **Plant-Prod MJ™** formulation, mixed in a separate tank. This completely chelated formulation of calcium (Ca) and magnesium (Mg) in a 2:1 ratio avoids the risk of interfering with bud formation, setting and sizing. Rate should be determined by water sample results, provided by your Plant-Prod sales representative.



Plant-Prod MJ™ fertilizers are available in 15 kg bags.





GROWING
Media



PROMIX

Growing Media

PRO-MIX® BX Biofungicide + Mycorrhizae

General purpose peat-based professional growing medium designed for general greenhouse use and transplanting applications. Perlite and vermiculite provide a balance of moisture and nutrient retention along with good drainage creating an ideal growing environment. With biofungicide and mycorrhizae added.



2.8cu ft Loose Fill Bag (57/PL)

PRB1028500RG

UPC 25849115005

Min Buy 1 BG

3.8cu ft Compressed Bale (30/PL)

PRB1038500RG

UPC 25849125004

Min Buy 1 BG



PRO-MIX® BX Mycorrhizae

General purpose peat-based professional growing medium designed for general greenhouse use and transplanting applications. Perlite and vermiculite provide a balance of moisture and nutrient retention along with good drainage creating an ideal growing environment. With mycorrhizae added.



2.8cu ft Loose Fill Bag (57/PL)

PRB10281RG

UPC 25849102814

Min Buy 1 EA

3.8cu ft Compressed Bale (30/PL)

PRB10381RG

UPC 25849103811

Min Buy 1 EA



PRO-MIX® CC40 Mycorrhizae

A high-porosity peat-based growing medium that contains chunk coir. With high air porosity and water retention, it is ideal for long-term crops especially where subjected to drought conditions. The water retention qualities of this peat/coir mix reduce irrigation requirements and allow growers to more efficiently react to challenging environments. With mycorrhizae added.



3.8cu ft Compressed Bale (30/PL)

PRB9038130RG

UPC 25849310233

Min Buy 1 EA



PRO-MIX® HP Biofungicide + Mycorrhizae

High porosity peat-based growing medium. Perlite ensures optimum growth, especially when high air capacity and extra drainage are required. An ideal formulation for growers in need of a media adapted to watering flexibility and crop seasonality. With biofungicide and mycorrhizae added.



2.8cu ft Loose Fill Bag (57/PL)

PRB2028500RG

UPC 25849215002

Min Buy 1 BG

3.8cu ft Compressed Bale (30/PL)

PRB2038500RG

UPC 25849225001

Min Buy 1 EA



PRO-MIX® HP Mycorrhizae

High porosity peat-based growing medium. Perlite ensures optimum growth, especially when high air capacity and extra drainage are required. An ideal formulation for growers in need of a media adapted to watering flexibility and crop seasonality. With mycorrhizae added.



2.8cu ft Loose Fill Bag (57/PL)

PRB20281RG

UPC 25849202811

Min Buy 1 BG

3.8cu ft Compressed Bale (30/PL)

PRB20381RG

UPC 25849203818

Min Buy 1 EA



PRO-MIX® HPCC Mycorrhizae

A lightweight, high-porosity peat-based growing mix containing chunk coir for balanced drainage and moisture retention and increased resistance to compaction. With mycorrhizae added.



2.8cu ft Loose Fill Bag (57/PL)

PRB2028130RG

UPC 25849211301

Min Buy 1 EA

3.8cu ft Compressed Bale (30/PL)

PRB2038130RG

UPC 25849221300

Min Buy 1 EA



PRO-MIX® MP Organik Mycorrhizae

OMRI listed organic multi-purpose growing medium with well balanced air/water qualities. Designed to meet crop requirements for organic growers of herbs and vegetables. All of the basic components that have been selected and formulated are OMRI listed and approved. With mycorrhizae added.



2.8cu ft Loose Fill Bag (57/PL)

PRB8028101RG

UPC 25849811013

Min Buy 1 BG

3.8cu ft Compressed Bale (30/PL)

PRB8038103RG

UPC 25849821012

Min Buy 1 BG





PROMIX®

Other

PRO-MOSS® Hort Peat Moss

Ideal for indoor and outdoor horticultural applications. Saves water and aerates soils. Adds organic content to sandy soils. Contains: Canadian sphagnum peat moss. ORMI® listed for organic use.



3.8cu ft Compressed Bale

PRB0078P

UPC 25849000783

Min Buy 1 EA



Growing Media

FoxFarm® Bush Doctor® Coco Loco® Potting Mix

Plants growing in Coco Loco® will not require water as often as your usual potting mix. Whether you're growing in hanging baskets, vertical gardens, containers or seedling trays, extend your watering schedule. In most climates, every two to three days will be enough. Always adjust your watering schedule as needed.



12qt (120/PL)

FXF591075

UPC 752289591075

Min Buy 1 EA

2cu ft (48/PL)

FXF591020

UPC 752289591020

Min Buy 1 EA

27cu ft

FXF582257

UPC 752289582257

Min Buy 3 EA

55cu ft

FXF582059

UPC 752298582059

Min Buy 2 EA



FoxFarm® Cultivation Nation® Seventy Thirty Growing Media

Cultivation Nation® Seventy Thirty Growing Media is a mixture of buffered coconut coir and perlite, blended in the classic ratio of 70:30. Coconut coir is known for its water holding capabilities, and perlite is included to provide air spaces in the media, facilitating aeration and drainage. Cultivation Nation® Seventy Thirty Growing Media is great for use with customized feeding schedules in indoor and outdoor containers.



2cu ft

FXF690068

UPC 752289690068

Min Buy 1 EA

55cu ft tote

FXF690082

UPC 752289690082

Min Buy 1 EA

27cu ft tote

FXF690075

UPC 752289690075

Min Buy 1 EA



FoxFarm® Happy Frog® Potting Soil

Your potted plants deserve the best. Their roots can't seek out nutrition in the ground, so you have to bring it to them. That's why Happy Frog® Potting Soil is amended with soil microbes that can help improve root efficiency and encourage nutrient uptake. Between the earthworm castings, bat guano and aged forest products, your container plants have never felt so good.



12qt (120/PL)

FXF590016

UPC 752289590016

Min Buy 5 EA

27cu ft

FXF582233

UPC 752289582233

Min Buy 3 EA

2cu ft - West Only
(48/PL)

FXFHF20W

UPC 752289590023

Min Buy 1 EA

55cu ft (2/PL)

FXF582035

UPC 752289582035

Min Buy 1 EA

2cu ft (60/PL)

FXF590023

UPC 752289590023

Min Buy 1 EA





Growing Media

FoxFarm® Happy Frog® Soil Conditioner

Happy Frog® Soil Conditioner you'll find finely-screened aged forest products, earthworm castings and bat guano, not to mention soil microbes to help increase root efficiency and encourage nutrient uptake. We also add humic acids, which may increase the uptake of important micronutrients.



1.5cu ft (75/PL)

FXF590047

UPC 752289590047

Min Buy 1 EA

27cu ft

FXF582318

UPC 752289582318

Min Buy 3 EA

55cu ft

FXF582110

UPC 752289582110

Min Buy 2 EA



FoxFarm® Ko Ko Bop™ Coconut Coir Blend

A blend of renewable coconut coir and aged forest products with perlite for aeration. This grow bag is ready for planting; plant directly into this bag for all growing applications. KO KO BOP™ and DROP – It Doesn't Get Any Easier!



3cu ft (36/PL)

FXF690051

UPC 752289690051

Min Buy 1 EA



FoxFarm® Light Warrior® Seed Starter

Light Warrior® Seed Starter is designed to promote an environment beneficial to seed germination and root development. Light Warrior® Seed Starter includes soil microbes that can help enhance root efficiency and encourage nutrient uptake. We also include earthworm castings, a gentle source of nutrition for seedlings and small plants. Use Light Warrior® Seed Starter for seed germination, cuttings and new plant starts for both indoor and outdoor cultivation.



1cu ft (75/PL)

FXF790096

UPC 752289790096

Min Buy 1 EA



FoxFarm® Lucky Dog® K-9 Kube® Potting Soil

This light airy blend of peat moss and perlite is the answer to every gardener's quandary. Unleash the Lucky Dog® K-9 Kube® Growers Blend and plant into this richly amended mix. Lucky Dog® Growers Blend comes right out of the bale with soil microbes that may enhance root efficiency. This can provide more opportunity for nutrient availability and may increase fruit and flower production. Use Lucky Dog® for rooted cuttings and young plant starts for both indoor and outdoor cultivation. Plant directly into Lucky Dog® Growers Blend.



3.8cu ft

FXF580048

UPC 752289580048

Min Buy 1 EA

2.2cu ft

FXF591068

UPC 752289591068

Min Buy 1 EA

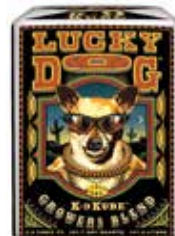

FoxFarm® Ocean Forest® Potting Soil

Our most popular potting soil, Ocean Forest® is a powerhouse blend of aged forest products, sphagnum peat moss, earthworm castings, bat guano, fish emulsion and crab meal. Aged forest products, sandy loam and sphagnum peat moss give Ocean Forest® its light, aerated texture. Start with Ocean Forest® and watch your plants come alive!



12qt (120/PL)

FXF790041

UPC 752289790041

Min Buy 5 EA

3cu ft (36/PL)

FXF690044

UPC 752289690044

Min Buy 1 EA

1.5cu ft - West Only
(64/PL)

FXFOF15W

UPC 752289790058

Min Buy 1 EA

27cu ft

FXF582219

UPC 752289582219

Min Buy 3 EA

1.5cu ft (75/PL)

FXF790058

UPC 752289790058

Min Buy 1 EA

55cu ft

FXF582011

UPC 752289582011

Min Buy 2 EA



FoxFarm® Original Planting Mix

Our Original Planting Mix is a blend of soil amendments such as aged forest products, sphagnum peat moss and earthworm castings. Use our Original Planting Mix for all your gardening projects. The aged forest products and peat moss in FoxFarm Original Planting Mix may make it more effective at holding moisture around the roots of plants. In turn, this may help you obtain glorious gardening results and save water at the same time.



1cu ft (75/PL)

FXF790010

UPC 752289790010

Min Buy 1 EA





Growing Media

FoxFarm® Salamander Soil® Water Holding Potting Mix

The smooth shiny Salamander is a true delight of Nature. These beautiful little creatures come in a bright kaleidoscope of colors and call these forests their home. Salamanders always find the right habitat to flourish in. We have created our water holding Salamander Soil® Potting Mix so that your plants can moisturize in the same way as this special animal. Your precious little seedlings and plants will have access to the benefits of a potting mix full of NEWT-tritive properties. Under the right moisture conditions beneficial microorganisms can flourish and NEWT-trient uptake may be enhanced. Plants that are grown in hot climates need that extra thirst quench so that they can stay vigorous and not get stressed from drying out. The inconvenience of frequent waterings is sometimes problematic for growers who just can't get to their plants in time. Moisture has to be accurate; too much will cause root rot and plants will suffer. Use Salamander Soil® for rooted cuttings and young plant starts for both indoor and outdoor cultivation. Plant directly into Salamander Soil® Potting Mix. Make Your Neighbors Jealous!



1.5cu ft (75/PL)

FXF591105

UPC 752289591105

Min Buy 1 EA

27cu ft

FXF582295

UPC 752289582295

Min Buy 3 EA

55cu ft

FXF582134

UPC 752289582134

Min Buy 2 EA



Growing Media

FoxFarm® Strawberry Fields® Potting Soil

Strawberry Fields® Fruiting & Flowering Potting Soil is designed to pump up your blooms, fruits and berries with no hang-ups. Brought to you directly from the Flower Children of the Sixties and Seventies—the Old School generation. Love, Peace and Happiness is in our hearts and that is exactly what we pour into every bag of Strawberry Fields®. Out-A-Sight!



1.5cu ft (75/PL)

FXF591044

UPC 752289591044

Min Buy 1 EA

27cu ft (3/PL)

FXF582349

UPC 752289582349

Min Buy 3 EA



Other

FoxFarm® Big & Chunky® Perlite

Use Big & Chunky® Perlite in containers with our Ocean Forest® or Happy Frog® Potting Soil to help improve drainage and keep roots oxygenated. Use it as a stand-alone hydroponic grow medium, or combine it with our Light Warrior® Seed Starter for your cuttings and seedlings.



4cu ft (30/PL)

FXF411045

UPC 752289411045

Min Buy 1 EA



Growing Media

Lambert® LM-6 High Porosity Mix

A high porosity growing media with long-fibered Canadian Sphagnum peat moss including the addition of large peat chunks and coarse perlite. Designed for crops that require higher air capacity and drainage.



3cu ft

LP02365

Min Buy 1 EA

3.8cu ft

LP02360

Min Buy 1 EA





Growing Media

Sun Gro® Sunshine® #4 Professional Growing Mix

Contains coarse perlite for high air capacity and fast drainage. Ideal for water and salt sensitive crops or where frequent leaching is required. Highly recommended for nursery stock, perennials, cutting propagation, hanging baskets and interiorscape. Contains RESILIENCE® our silicon-enriched additive – may improve trichome results, resistance to wilting and enhance plant growth and flowering.



3.8cu ft Compressed Bale (30/PL)

SUN50438CFP

UPC 64277074447

Min Buy 1 BL



Growing Media

ASB Greenworld® Grower Mix VPW 420

Professional growing medium made of coarse fibrous peat moss, perlite and vermiculite for the best balance of porosity, water holding capacity, and nutrient retention. Also includes the best Mycorrhizae fungi by Mycorrhizal Applications, which increases plant establishment, drought protection, improves healthy soil biology for better nutrient uptake and reduces production costs.



3.8cu ft Compressed Bale (30/PL)

ASB313780

UPC 872552001022

Min Buy 1 EA



Sunshine® Mix #4 with Mycorrhizae

For indoor growing. Contains horticultural grade perlite for greater porosity. Our classic #4 boosted with Sun Gro's proprietary seven mycorrhizae species. Contains RESILIENCE® our silicon-enriched additive – may improve trichome results, resistance to wilting and enhance plant growth and flowering.



3cu ft Compressed Bale (35/PL)

SUN5047040CFC003P

UPC 64277064097

Min Buy 1 EA



ASB Greenworld® Garden Boss Organic Potting Mix

Organic Garden Boss Potting Mix is an OMRI Listed potting soil that promotes stronger and healthier plants. Our environmentally friendly mix with HydraFiber provides a soil structure, so roots have better access to water and air. Whether growing medicinal or edible crops; bigger blooms, fruits and flowers will benefit from Mycorrhizae microbes and fungi that help break down organic matter and feed your plants roots. Organic Garden Boss Potting Mix fortified with Mycorrhizae by Mycorrhizal Applications and ASB-O-Mite (minors nutrient package) is an enriched soil that is perfect for all your indoor and outdoor gardening needs.



2cu ft Loose Fill Bag

ASB600892

UPC 45571860448

Min Buy 1 EA



Sunshine® Advanced Mix #4

Recommended for indoor growing. This Myco-active mix retains moisture while providing improved root aeration and drainage. Contains RESILIENCE® our silicon-enriched additive – may improve trichome results, resistance to wilting and enhance plant growth and flowering. OMRI® Listed - for organic gardening.



3cu ft Compressed Bale (35/PL)

SUN504500cfc003p

UPC 64277310309

Min Buy 1 EA



Growing Media

Roots Organics Emerald Mountain

Created for the quality conscious consumer, the special breed looking for the highest levels of performance and economy. We recognized the need for a more economical organic growing media that incorporates a balanced air to water ratio for water retention and porosity while maintaining a reliably free draining indoor and outdoor potting mix. The ultimate base mix or large container outdoor blend consistently created to out perform. Emerald Mountain potting mix has been extensively tested and you will see the results of our effort designing this excellent base blend in your garden.



1.5cu ft (70/PL)

AURROEM

UPC 609728631956

Min Buy 1 EA



Roots Organics Formula 707

Formula 707 is a ready-to-use soil created for a special kind of gardener, those who want to control their own destiny. Formula 707 is different from the other growing mixes created by Aurora Innovations. It was designed with greater water-holding capacity, fewer nutrients, less perlite and less pumice, and it contains ingredients specific to large container gardening. In fact, the packaging is a 30-gallon grow bag containing about 20 gallons of the finest quality potting mix. Just punch holes in the bottom, cut off the top and plant.



1.5cu ft (70/PL)

AURRO70715

UPC 609728631901

Min Buy 1 EA

3cu ft (36/PL)

AURRO707

UPC 609728631895

Min Buy 1 EA



Roots Organics Green Fields

An ocean-nutrient-based growing mix designed for both the vegetative-and flowering phases of mature plants. Green Fields was designed with greater water-holding capacity, yet it is free-draining for frequent feeding of fast-growing, heavy feeding plants. Green Fields is a ready-to-use soil created with less perlite and pumice, and specific ingredients such as fish meal and crab meal, worm castings, bat guano, and kelp meal. Experienced gardeners know that a perfect outdoor mix is different than a perfect indoor mix, and Green Fields has been proven as an excellent outdoor blend for your fast-growing plants.



1.5cu ft (70/PL)

AURROGF

UPC 609728631871

Min Buy 1 EA



Roots Organics Green Lite

Roots Organics Green Lite growing mix was created as an aggressively free-draining indoor and outdoor potting mix. Green Lite is designed with more perlite and pumice to give you enhanced drainage and greater oxygen in the root zone, and with specific ingredients for versatile container gardening. This mix has been extensively tested; you'll see the results when you use this excellent, highly porous blend in your garden. Roots Organics Green Lite is calculated to give you control and accelerate your garden for vigorous plants and root systems.



1.5cu ft (70/PL)

AURROGL

UPC 609728631888

Min Buy 1 EA



Roots Organics Lush Potting Soil

Roots Organics Lush growing mix is an amended peat-based media that delivers absolute consistency and control. What makes Lush superior to the competition? Nutrient-rich, this robust mix combines a well-measured primary fertility package with ideal foundational components to maximize yield in mature flowering plants. The precise ratio of peat, coir, perlite, pumice and worm castings has been added to create ideal water holding capacity and drainage. Rich in sustaining nutrients, this media is designed for a water-only or reduced nutrient schedule. In fact, most plants can happily feed on Lush for up to eight weeks without additional support.



1.5cu ft

AURROL15

UPC 799493712483

Min Buy 1 EA



Roots Organics Micro-Greens

Roots Organics Micro-Greens starter and seedling mix is designed for absolute consistency and control as a direct sowing media or as an ideal microgreens substrate. With a balanced air to water ratio for water retention and drainage; ready for your seeds, young plants or favorite microgreens. Pick it up and grow, the control is in your hands. The Roots Organics Micro-Greens is composed of only outstanding ingredients for excellent performance and flexibility to encourage vigor in your start or microgreens mix.



1.5cu ft (75/PL)

AURROMG

UPC 609728632038

Min Buy 1 EA



Roots Organics Original Potting Soil

A ready to use mix created with a balanced air to water ratio of porosity and water retention to allow for frequent feeding of fast growing, heavy feeding plants. For exceptional results, feed with high quality nutrients, such as the Roots Organics fertilizer line.



.75cu ft (140/PL)

AURRODMB

UPC 609728631840

Min Buy 1 EA

3cu ft (36/PL)

AURROD3

UPC 609728632045

Min Buy 1 EA

1.5cu ft (70/PL)

AURROD

UPC 609728631857

Min Buy 1 EA





Growing Media

Roots Organics Soul Coco Growing Mix

A superior bulk coir media that provides the ideal air-to-water ratio to support lush root growth.



1.5cu ft (75/PL)

AURSC

UPC 799493712070

Min Buy 1 EA



Roots Organics Coco Chips

Roots Organics Coco Chips have a near perfect natural pH level (5.2-6.3) for optimum nutrient uptake. Roots Organics Coco Chips are premium chips that are age cured and meticulously washed to remove excess sodium. Roots Organics Coco Chips are ideal for mixing into outdoor potting soils or indoor container media so that growers can adjust the air to water ratio for an optimal balance of water retention and drainage. Roots Organics Coco Chips are composed of 100% pure coco fiber from coconut husks.



4.5k (189/PL)

AURROCB

UPC 609728631994

Min Buy 1 EA



Roots Organics Coco Fiber

Roots Organics Coco Fiber has a near perfect natural pH level (5.2-6.3) for optimum nutrient uptake. Roots Organics Coco Fiber is premium coco that has been age cured and meticulously washed to remove excess sodium. Roots Organics Coco Fiber has been specifically designed with increased fiber content for an ideal air to water ratio, and is ideal for mixing into your outdoor potting soils, or your indoor potting soil media. Roots Organics Coco Fiber is composed of 100% pure coco fiber from coconut husks.



5k

AURROCB

UPC 609728631987

Min Buy 1 EA



Other

Roots Organics Big Worm Soil

Roots Organics Big Worm pure and premium worm castings is a distinctive natural soil amendment. Our earthworms are carefully tended and fed an unparalleled blend of organic and natural feedstocks for exceptional quality worm castings. No fillers, no chemicals and no tricks. Just pure and exceptional worm castings.



12qt (84/PL)

AURROBW12Q

UPC 609728631949

Min Buy 1 EA

1cu ft (60/PL)

AURROBW

UPC 609728631918

Min Buy 1 EA



Roots Organics Earth Worm

Roots Organics Earth Worm vermicompost contains organic matter to assist in soil aggregation and improve cation exchange capacity of soils. Our earthworms are carefully tended and fed an unparalleled blend of natural and organic feedstocks for exceptional quality vermicompost. Roots Organics Earth Worm is a great amendment or top dress to aid in the proliferation of soil microbes and encourage vigorous root growth.



1cu ft (60/PL)

AURROEW

UPC 609728631970

Min Buy 60 EA



Coast of Maine

Growing Media

COM Stonington Blend™ Organic & Natural Grower's Mix

Grow Clean! This complex "super soil" will take your plants growing in the vegetative stage to the next level! OMRI Listed.



1.5cu ft (60/PL)
CME1CBSBPGM15CF
 UPC 609853000689
 Min Buy 6 EA



Growing Media

COM Organic & Natural Raised Bed Mix

An enriched blend of fully cured, locally-sourced compost, peat, biochar, worm castings, dehydrated poultry manure, kelp meal, lobster meal, greensand, lime and mycorrhizae. Great for growing healthy vegetables, herbs and flowers. OMRI Listed.



2cu ft (48/PL)
CME1CBCRB2
 UPC 609853000931
 Min Buy 4 EA



Propagation

COM Sprout Island Blend™ Organic & Natural Seed Starter

A rich mixture of blended mycorrhizae, sphagnum peat moss, well-aged compost, perlite, lime, kelp meal, worm castings and lobster meal. Designed specifically for germinating seeds and rooting cuttings and growing them into healthy, disease resistant plants. OMRI Listed.



2cu ft (48/PL)
CME1CBSI2
 UPC 609853000924
 Min Buy 6 EA



COM Bar Harbor Blend™ Organic & Natural Potting Soil

This great all-purpose potting soil is made with natural and organic ingredients such as lobster, kelp, compost, perlite and sphagnum peat. It is designed for potting indoor and outdoor container plants. Water and fertilize less with this nutrient rich, compost based potting soil. OMRI Listed.



2cu ft (48/PL)
CME1CBBH2
 UPC 609853000467
 Min Buy 4 EA



DAKINE 420

HIGH YIELD SCIENCE

Growing Media

DaKine 420 Coco Coir Lite: Aeration Formula

Dakine 420 Coco Coir Lite is a soilless grow medium that maintains an ideal air-to-water ratio for indoor, greenhouse or outdoor growing. Made with premium, high-pith coconut coir fiber, Coco Coir Lite is double washed to remove excess salts, and precisely blended to maintain optimal water-to-air ratios.



1.5cu ft bag
DAKLITEBAG
 UPC 728028347593
 Min Buy 1 EA
 54cu ft tote
DAKLITETOTE
 UPC 728028352375
 Min Buy 1 EA



DaKine 420 Organic Coco Coir Blend

Organic Coco Coir Blend is an all-natural soilless grow medium made with the finest all-natural ingredients. Our Mad Scientist and his "main squeeze," Mother Nature, teamed up to blend the perfect ratios of coco coir pith, peat moss, perlite, compost, montmorillonite, worm castings, fish bone meal, bat guano, kelp meal, endomycorrhizae, beneficial bacteria and bio minerals to keep your cannabis content!



1.5cu ft bag
DAKIOGBAG
 UPC 728028347609
 Min Buy 1 EA
 54cu ft tote
DAKIOGTOTE
 UPC 728028352382
 Min Buy 1 EA



DaKine 420 Pure Coco Coir

Pure Coco Coir is a soil-less coco coir-based grow medium made with Premium 100% pure, double-washed, high-quality coco coir pith. It is suitable for indoor, greenhouse and outdoor use, either alone or mixed with your favorite amendments



54cu ft tote
DAKPURETOTE
 UPC 728028352368
 Min Buy 1 EA
 1.5cu ft bag
DAKPUREBAG
 UPC 728028347586
 Min Buy 1 EA





Growing Media

DNC Great Lakes Water Only Soil

Great Lakes Water Only is an all-natural start-to-finish soil. This living soil is water-only. From seed or clone until harvest, our patented blend of worm castings, steer manure, and chicken compost, along with our incredible list of high-quality amendments creates plant-available food at each stage of development. For novice gardeners Great Lakes Water Only soil works perfectly. Forget mixing chemicals and troubleshooting deficiencies!



1 cu ft - (75/PL)

DNCWTR27016

UPC 86000148718

Min Buy 1 EA

1 cu ft (52/PL), 40pcs of the water only and 12pcs of the vermicompost

DNCMIXPLT

Min Buy 1 PL



Other

DNC Vermicompost 100% Worm Castings

Detroit Nutrient Company worm castings set the standard for quality in vermicompost. Our worms are fed a fixed diet, and left to create a high-quality casting that is excellent for use in soil building, top dresses, amending and making inoculation and compost A.A.C.T. Indoors for use with bottle nutrients, a handful of castings in every planting hole increases plant vigor and health as well as adding to yield.



25lb (60/PL)

DNCVRM30257

UPC 28412127016

Min Buy 1 EA



Other

SPV #3 Medium Vermiculite

Horticultural Vermiculite #3 is small, mighty, and in charge. This grade of vermiculite has small, absorbent particles which have more surface area than large-sized particles, resulting in superior water- and nutrient-holding capabilities. It is non-organic and ready to use. With a negative charge, it provides an excellent cation-exchange capacity and attracts and holds positively charged ions.



64cu ft (2/PL)

DLP3MV64CF

Min Buy 2 EA

Harvest Hero Enhanced Perlite Mix (Low Dust)

This innovative 3-in-1 Mix features a unique, proprietary blend of perlite, diatomaceous earth and essential nutrients that supports robust, vigorous growth throughout vegetative growth. Harvest Hero's proprietary nutrient coating ensures a low-dust product that is unrivaled on the market. 12-24 qt and 64 cu ft bags also are also available. Looking for an organic alternative? Ask about their Perlite+ Silica and Hydroponic Perlite.



3cu ft (30/PL)

DLPHH3CF

Min Buy 1 EA

Dicalite Aero-Soil Perlite

Perlite is one of nature's most versatile and efficient minerals. Dicalite's Aero-Soil horticultural perlite is an easy-to-use, lightweight and sterile soil conditioner that is beneficial for commercial growers, landscapers and home gardeners.



64cu ft (2/PL)

DLPASP64CF

Min Buy 2 EA

Dicalite Aero-Soil Horticultural Perlite

Perlite is one of nature's most versatile and efficient minerals. Dicalite's OMRI-listed Aero-Soil horticultural perlite is an easy-to-use, lightweight and sterile soil conditioner that is beneficial for commercial growers, landscapers and home gardeners.



4cu ft (39/PL)

DLPASP4CF

Min Buy 1 EA

SPV Horticultural Vermiculite

Horticultural Vermiculite is small, mighty and in charge. This grade of vermiculite has small, absorbent particles which have more surface area than large-sized particles, resulting in superior water- and nutrient-holding capabilities. It is non-organic and ready to use. With a negative charge, it provides an excellent cation-exchange capacity and attracts and holds positively charged ions.



4cu ft (36/PL)

DLP3MV4CF

Min Buy 1 EA



Growing Media

Espoma® Organic® Potting Mix

Enhanced with earthworm castings and Myco-tone™ for stronger roots. For all indoor and outdoor containers and potted plants. can be used for organic gardening. Contains a rich blend of only the finest natural ingredients. No synthetic plant foods or chemicals are used. All natural and organic, premium quality blends.



2cu ft (48/PL)
ESPAP2
 UPC 50197701020
 Min Buy 1 EA



Other

Espoma® Land & Sea Gourmet Compost

Espoma Organic Land & Sea Gourmet Compost is a special blend of the finest ingredients available. It combines peat and humus from the land and crab and lobster shells from the sea to create a high quality finished compost.



1cu ft (75/PL)
ESPLSC1
 UPC 50197715010
 Min Buy 1 EA



Espoma® Mushroom Compost

Mushroom compost for adding organic humus. Helps to improve poor soils and grow better plants.



.75cu ft (75/PL)
ESPMC75
 UPC 50197717755
 Min Buy 1 EA



Espoma® Organic® Seed Starter Mix

Enhanced with Myco-Tone™ for stronger roots. For all seedlings and cuttings.



8qt
ESPSS8
 UPC 50197705080
 Min Buy 6 EA
 16qt (120/PL)
ESPSS16
 UPC 050197705165
 Min Buy 1 EA



Espoma® Organic® Perlite

All natural, 100% pure Perlite. For seed starting or blending a custom potting mix. Helps loosen heavy soil and prevents compaction. Promotes root growth.



8qt
ESPPR8
 UPC 50197707084
 Min Buy 6 EA



Espoma® Organic® Vermiculite

All natural, 100% pure Vermiculite. For seed starting or blending a custom potting mix. Helps loosen heavy soil and prevents compaction. Promotes root growth.



8qt
ESPVM8
 UPC 50197708081
 Min Buy 6 EA





Growing Media

Hoffman® Bonsai Soil Mix

Professionally formulated to provide optimum growth for evergreen and other Bonsai plants. Provides the plant support, moisture and drainage Bonsai need. Pre-mixed, ready to use and excellent for repotting.



2qt
HOF10708
 UPC 71605107081
 Min Buy 10 EA



Hoffman® Organic Cactus & Succulent Soil Mix

Ready to use and professionally formulated for jungle and desert cacti. Provides drainage cacti need to flourish. pH balanced. Encourages bloom and root development.



4qt
HOF10404
 UPC 71605114041
 Min Buy 12 EA

10qt
HOF10410
 UPC 71605104103
 Min Buy 6 EA



Other

Hoffman® Horticultural Vermiculite

Soil conditioner (gold color) that loosens soil, provides aeration and retains water. Can be used to start seeds, propagate cuttings and store bulbs. Blend with peat moss and perlite for custom soilless mix.



8qt
HOF16002
 UPC 71605160024
 Min Buy 6 EA

18qt (128/PL)
HOF16004
 UPC 71605160048
 Min Buy 4 EA

2cu ft (60/PL)
HOF16045
 UPC 71605160178
 Min Buy 1 EA



Hoffman® Horticultural Perlite

Lightweight soil conditioner (white, powdery material) that loosens clay soil, reduces caking and improves drainage and aeration. Can be used to start seeds, propagate cuttings and store bulbs. Blend with peat moss and vermiculite for custom soilless mix.



8qt
HOF16502
 UPC 71605165029
 Min Buy 6 EA

18qt
HOF16504
 UPC 71605165043
 Min Buy 4 EA

2cu ft (60/PL)
HOF16545
 UPC 71605165173
 Min Buy 1 EA



Other

Gaia Green Worm Castings

GAIA GREEN Worm Castings are the unprocessed manure of earthworms. This all-purpose fertilizer is high in organic matter, and adds essential nutrients to the soil to encourage strong plant growth. Apply as a top dressing, side dressing or work into soil for outstanding growth. Recommended for household plants, urban gardens, lawns, golf courses, nurseries and greenhouses.



30L
GRN786620926
 UPC 678662001361
 Min Buy 1 EA



Gaia Green Worm Castings 2-0-0

GAIA GREEN Worm Castings are the unprocessed manure of earthworms. This all-purpose fertilizer is high in organic matter and adds essential nutrients to the soil to encourage strong plant growth. Apply as a top dressing, side dressing, or work into soil for outstanding growth. Recommended for household plants, urban gardens, lawns, golf courses, nurseries and greenhouses.



2L
GRN786620925
 UPC 678662001354
 Min Buy 6 EA



Growing Media

Grower Select® H2 Professional Mix

H2 Professional Mix is a heavy-weight bark mix formulated for use in larger containers and longer term crops, both in greenhouses and outdoors. H2's higher ratio of bark:peat gives it an excellent balance of porosity and water holding capacity. 55% Bark, 30% Peat Moss, 15% Perlite



2.8cu ft Loose Fill Bag (42/PL)

PRBBFGGSH228

UPC 49121016514

Min Buy 1 EA



Grower Select® M2 Professional Mix

M2 Professional Mix is a lower cost version of our ultra-popular M1 blend. M2 is a great performer on horticultural crops like bedding plants, perennials, nursery stock, perennials, hanging baskets and vegetables. 55% Peat Moss, 30% Bark, 15% Perlite



2.8cu ft Loose Fill Bag (48/PL)

PRBBFGGSM228

UPC 49121016507

Min Buy 1 EA



Propagation

HDI Root Riot® Plant Starter Cubes

Root Riot® is a natural plant starter cube ideal for soil or hydroponics. Suitable for both propagating cuttings and starting seeds, these cubes have been shown to consistently outperform alternative media. Root Riot cubes provide the perfect environment for root initiation and development. Made from composted natural materials, these plant starter plugs have a great spongy texture which retains the perfect air/water ratio for healthy, rapid root growth.



50 Bag

HDIRTRTBAG50

UPC 659627011076

Min Buy 20 EA

50 Tray

HDIRTRTRY50

UPC 659627011038

Min Buy 12 EA

100 Bag

HDIRTRTBAG100

UPC 502564481267

Min Buy 12 EA

1500ct - Bulk Box

HDIRTRTBULK

UPC 659627000605

Min Buy 1 EA

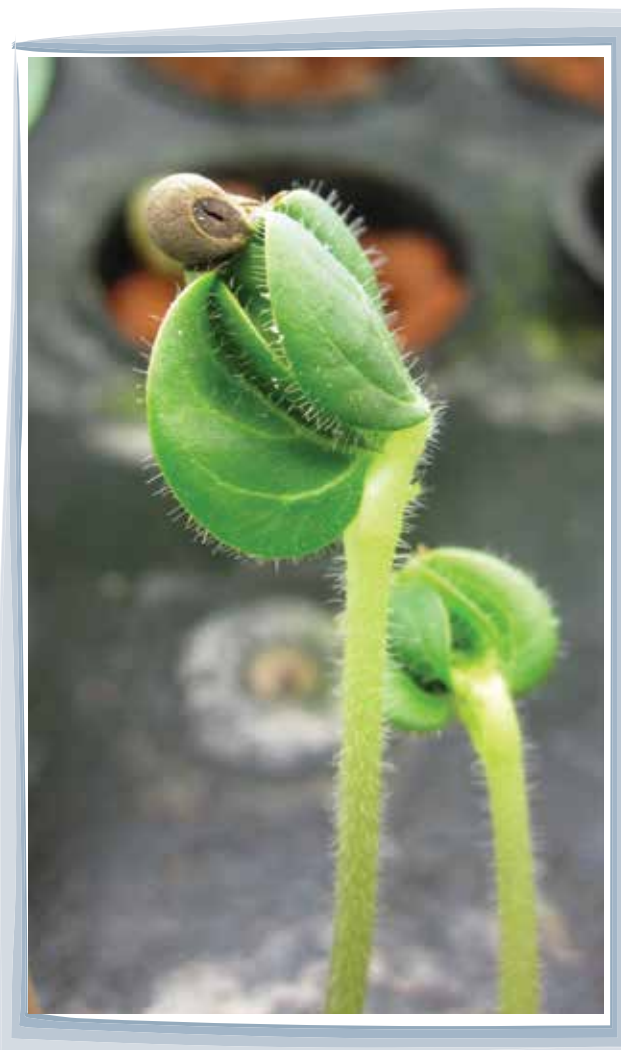



International Horticultural Technologies LLC



Perlite Vermiculite Packaging Industries, Inc.
Manufacturers of Consumer & Professional Growing Media and Soil Conditioners

Growing Media

Ihort® EXcel Plug Prefilled Tray

Ready to use. stick your cuttings or seedlings. Pre-filled trays allow quick response to your orders. Maintains air porosity for faster rooting. Healthier growth helps in disease prevention.



40/40
IHTX10LT50BX
Min Buy 1 CS

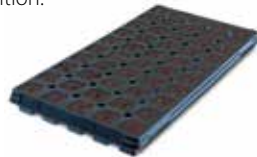

Ihort® Q Plug® Stabilized Rooting Media

Q plugs® are the key to maintaining a clean growing environment. They are specifically designed to germinate seedlings and rooting cuttings in a closely populated tray system. Q plugs® are engineered specifically so that they can later be transplanted into a larger space. This space can be open fields, growing beds or simply moved to larger containers.



20/60
IHTBQ450JSUP60
UPC 850001225076
Min Buy 15 EA

40/65
IHTQ40P162
Min Buy 1 CS



30/50
IHTBQ240ASUP78
UPC 850001225045
Min Buy 15 EA

40/80
IHTBQ72BSUP36
UPC 850001225069
Min Buy 15 EA

35/65
IHTBQB128SUP72
UPC 850001225021
Min Buy 15 EA

40/80
IHTQ40B72
Min Buy 1 CS

35/65
IHTQ40B128
Min Buy 1 CS

45/45
IHTBQ55BSUP72
UPC 850001225083
Min Buy 15 EA

40/40
IHTBQ162SSUP100
UPC 850001225014
Min Buy 15 EA

45/45
IHTQ40B55R
Min Buy 1 CS

40/40
IHTBQ162SSUP50
UPC 850001225007
Min Buy 30 EA

45/50
IHTQ40A126
Min Buy 1 CS

40/40
IHTQ40P162S
Min Buy 1 CS

4in x 4in
IHTQ4X4BLOCK
Min Buy 1 CS

40/65
IHTBQ162PSUP72
UPC 850001225038
Min Buy 15 EA

6in x 6in
IHTQ6X6BLOCK
Min Buy 1 CS

Other

PVP Industries® Coarse Horticultural Perlite

Used primarily in soil mixes, hydroponics and gardening. The standard Perlite. Horticultural perlite is clean, sterile, pH neutral, non-flammable, odorless, nontoxic and neither decays nor shrinks even pests such as insects and fungi can't destroy it.



4cu ft Bag (36/PL)
PVP105408
UPC 18296105408
Min Buy 1 BG



PVP Industries® Medium Horticultural Perlite

Used primarily for plugs, small cells, hanging baskets and gardening. Horticultural perlite is clean, sterile, pH neutral, non-flammable, odorless, nontoxic and neither decays nor shrinks even pests such as insects and fungi can't destroy it.



4cu ft Bag (36/PL)
PVP105705
UPC 18296105705
Min Buy 1 BG



PVP Industries® Medium Horticultural Vermiculite

Preferred for seeding, plugs, small cells and moisture retentive soil mixes. Horticultural vermiculite is permanent, clean, odorless, non-toxic, sterile and pH neutral. It will not deteriorate, turn moldy or rot. Mixed with soil, peat, composted pine bark, fertilizers, pesticides and herbicides and promotes faster root growth and quick anchorage to young roots. Vermiculite granules attract and hold ammonium, potassium, calcium and magnesium needed for the growing plants. Vermiculite/peat mixture provides excellent aeration and retention of plant food and moisture.



4cu ft Bag (36/PL)
PVP107402
UPC 18296106405
Min Buy 1 BG





Growing Media

Nectar for the Gods Potting Soil Blend #2

Nectar's soil-less medium, suitable for hydroponic use and daily Nectar feedings. Mixed in small batches. Coir fiber is rinsed on-site with Oregon rainwater and buffered with limestone to reduce salts. Ingredients: Coir fiber, perlite, yucca meal, basalt and mycorrhizal fungi.



1.5cf (60/PL)

NFGS2

UPC 812863010825

Min Buy 1 EA



Nectar for the Gods Potting Soil Blend #8

A variation on Nectar's #4 potting mix, this blend has the same ingredients, with 50% perlite for increased drainage. Suitable for daily feeding. Mixed in small batches. Coir fiber is rinsed on-site with Oregon rainwater and buffered with limestone to reduce salts. After blending and bagging, soil sits unwrapped and covered for up to 30 days to activate, compost and then go dormant, to avoid HOT soil. Ingredients: Sphagnum peat moss, perlite, coir fiber, pumice, mycorrhizal fungi, yucca meal, kelp meal, bone meal, diatomaceous earth, clay, basalt, oyster shell (for pH adjustment), humus and lime (for pH adjustment).



1.5cf (60/PL)

NFGS8

UPC 812863010832

Min Buy 1 EA



Nectar For The Gods Potting Soil Blend #4

A general potting mix designed for indoor and outdoor use. Suitable for multiple feedings per week. Mixed in small batches. Contains no bark or fillers. Coir fiber is rinsed on-site with Oregon rainwater and buffered with limestone to reduce salts. After blending and bagging, soil sits unwrapped and covered for up to 30 days to activate, compost and then go dormant, to avoid HOT soil. Ingredients: Sphagnum peat moss, perlite, coir fiber, pumice, mycorrhizal fungi, yucca meal, kelp meal, bone meal, diatomaceous earth, clay, basalt, oyster shell (for pH adjustment), humus and lime (for pH adjustment).



1.5cf (60/PL)

NFGS4

UPC 812863010818

Min Buy 1 EA



Nectar for the Gods 4Shot Potting Soil

Oregon's Only's newest addition to the soil blend offerings. 4Shot Potting Soil utilizes all of the same components as the #4 all-purpose soil blend, with the added benefit of One Shot time-release fertilizer blended into the mix. This is Oregon's Only's answer to an all-purpose, heavily amended, fertilized soil, incorporating coarse diatomaceous earth, One Shot, and the original fertilizer blend base of the #4 mix. Best when used in the flowering cycle or as a flowering stage soil. Transplanting into 4Shot before transitioning plants into flowering will greatly benefit the overall outcome of the crop. Ingredients: Pumice, sphagnum peat moss, clay, coir fiber, perlite, reed sedge peat, basalt, limestone (for pH adjustment), oyster shell (for pH adjustment), yucca meal, mycorrhizal fungi, diatomaceous earth, Earthworm castings, kelp meal, bone meal, fish bone meal, kelp extract, feather meal, alfalfa meal, and soybean meal



1.5cf (60/PL)

NFGSFS

UPC 812863012386

Min Buy 1 EA





Growing Media

Malibu Compost Baby Bu's™ Biodynamic® Potting Soil

"Made from an extraordinary recipe of Bu's™ Blend Biodynamic® Compost and premium ingredients." A premium coco coir-based potting soil, with 25% Biodynamic compost blended with high quality organic and GMO-free amendments unlike any other truly organic product on the market today. Free from GMO's, pesticides, growth hormones, sewage sludge and synthetic chemicals * saves water by encouraging appropriate moisture absorption and dissipation * ready to plant for seeds, seedlings, transplants and houseplants. INGREDIENTS: Coir, compost (dairy cow manure, wood chips, straw, concentrations of yarrow, chamomile, valerian, stinging nettle, dandelion and oak bark), fir bark, perlite, worm castings, soybean meal, fish meal, fish bone meal, langbeinite, alfalfa meal, crab meal, green sand, neem seed meal, volcanic ash and kelp meal.



1.5cu ft
MAL5001
 UPC 705105902975
 Min Buy 1 EA



Other

Malibu Compost Bu's™ Blend Biodynamic® Compost

This compost repairs your soil's ecosystem, saves water and serves as a source of humus for planting and managing soil health while amending your soil for vegetables, plants, flowers, lawns and gardens, giving them nutrients they need. For use with native soils or quality potting or planting mixes. Improves clay, compacted, or otherwise poor soils. Ingredients: Dairy cow manure, straw, vineyard wood chips and biodynamic concentrations of yarrow, chamomile, valerian, stinging nettle, dandelion and oak bark.



1cu ft
MAL1001
 UPC 705105669649
 Min Buy 1 EA



Propagation

Malibu Compost Bu's Beginnings™ Biodynamic® Seed Starter

Bu's Beginnings Biodynamic Seed Starter is a unique product when it comes to growing from seed. Bu's Beginnings has all of the nutrients and that your seeds need to germinate, survive and thrive from the microbial life that is in the Bu's Blend Biodynamic Compost. Each bag of Bu's Beginnings has farm-made, true organic and biodynamic compost in it. Whether you are starting seeds for your vegetable garden or are growing micro greens for salads and smoothies, Bu's Beginning has the environment and ingredients that ensure success and vitality, as well as having organic starts, seedlings and micro greens that are grown organically from the start.



12qt
MAL8002
 UPC 752830779099
 Min Buy 1 EA



Propagation

Ferry-Morse® Fiber Seed Starting Strips

Biodegradable pots, made from organic recycled materials. When plants mature, plant pot and all into ground, allowing plant roots remain undisturbed. Eliminates transplant shock.



1.75in - 10 Pot Strip - 5pk
PLPFS110
 UPC 23075051104
 Min Buy 32 EA



Growing Media

Luster Leaf® Coco Coir

Natural coco coir pith in compressed brick.



10lb
LUS1270
 UPC 35307012708
 Min Buy 4 EA





Propagation

Riococo® Closed Bottom Organic Plug

Propagation plug is a super washed coir pellet with compressed coir fiber natural pith material. Our CBOP 2346 plug is made with carefully selected fine grade coir raw material. The key feature of this plug is that it's a bottom sealed coir plug wrapped with biodegradable paper cellulose. It can be used to grow in the propagation trays.



32mm

RCP32

Min Buy 2500 EA



Riococo® PCM Starter Block

Propagate faster and produce healthy plants organically. Excellent water holding and equal distribution of water throughout the starter block ensures optimum management of the air and water. PCM Starter block is made from 100% coir fiber without fine dust particles and its compressed to a square disc and packed in a biodegradable cellulose sack. The airy and fragile structure is maintained throughout the propagation cycle, until transplant into a separate growing container.



4in x 4in

PCMSB01

Min Buy 275 EA



Growing Media

Riococo® Grow Bag Slab

A special blend of coir chip and natural material. The selected raw materials are five times washed, blended without fine dust particles to make grow slabs for the required sizes. Slab has very high air fill porosity, moderate water holding capacity and balanced pH with very low EC and Sodium (Na) content. Grow slab has evenly distributed martial mix packed in UV stabilized co-extruded bags.



15L

PMCGB01

Min Buy 1 EA

18L

PMCGB02

Min Buy 1 EA



Riococo® PCM 4.5kg Coir Block

RIOCOCO Natural PCM mix coir block is made from fresh coir fiber natural and crush chip materials blended together and compressed to a 4.5 Kg/10 Lb format. It is a heat-treated and five timeswashed products with higher air fill porosity is over 28% and moderate water holding capacity. Natural PCM coir mix can be use straight without adding any perlite or any other type of media to increase the aeration.



10lb - 14.5gal

PCMB02

Min Buy 1 EA



Riococo® PCM Open Top Bag

RIOCOCO PCM OTBs (Open Top Bags) are produced with a special blend of coconut fiber raw materials, which provides the ideal coco medium characteristics to the plants. The selected raw materials are five times washed, blended without fine dust particles to make PCM OTBs for the required sizes. This product is specially designed to reach the optimum water holding capacity (WHC) and air-filled porosity (AFP).



1gal

PMCOTB01

Min Buy 44 EA

3gal

PMCOTB03

Min Buy 9 EA

2gal

PMCOTB02

Min Buy 18 EA

5gal

PMCOTB05

Min Buy 6 EA



Riococo® PCM Closed Top Bag

Produced with a special blend of coconut fiber raw materials, which provides the ideal coco medium characteristics to the plants. The selected raw materials are five times washed, blended without fine dust particles to make 1 Gallons PCM CTBs. This product is specially designed to reach the optimum water holding capacity (WHC) and air-filled porosity (AFP).



1gal

PMCTB01

Min Buy 44 EA





Growing Media

Royal Gold Basement Mix

Royal Gold Basement Mix sets the standard for coco fiber based potting mixes. Developed through years of field application and trial and error, Basement Mix allows traditional container style gardeners to get the benefits of coco fiber without completely changing their system. Basement Mix is ready to use straight from the bag, with top quality dry amendments, and features an even balance of water holding and air holding capacities. Basement Mix performs successfully with organic / biological based programs and conventional feeding methods. It's designed to be fed with a complete nutrient program. Whether you water by hand or automate with drip emitters, sprayers or flood systems, Basement Mix will help turn your basement (or any extra space) into the jungle of your dreams!



1.5cu ft
RGSEASMENT15
 UPC 850015617102
 Min Buy 1 EA



Royal Gold Coco Fiber

Royal Gold Coco Fiber is your choice for premium, clean, quality and consistent coconut fiber growing medium. Our loose coco is ready to use straight out of the bag as a stand-alone medium, soil conditioner, or a base for your own personal creation. Royal Gold imports the finest coco available and takes extreme care in meticulously rinsing and buffering all of our Coco fiber, at our own facility. Each batch is analyzed for nutrient and salt content, by an independent lab. This gives far greater quality control and consistency in our end product.



1.76cu ft
RGSCOCO176
 UPC 850015617003
 Min Buy 1 EA



Royal Gold Kings Mix

Royal Gold Kings Mix is your plant in bag solution for light deprivation, greenhouse, indoor, and outdoor gardens of any type. Born out of a need for simplicity in application and functionality, Kings Mix is a well-aerated, moderately amended coco peat blend. As Royal Gold's first product to include peat moss, this mix will appeal equally to traditional peat gardeners of all styles, the coco curious, as well as die-hard coco fanatics. Featuring coco chips (croutons) to balance aeration with lingering water retention, this mix is intended to dry quickly and accept immediate feeding. With a light amendment charge including high nitrogen, high phosphorus bat guano, and a mixture of other high-quality dry amendments, Kings Mix has everything you need to sustain your plants for about 1-2 weeks. You can also begin a wide range of feeding programs right out of the bag.



2cu ft
RGSKINGS2
 UPC 850015617072
 Min Buy 1 EA
 3cu ft
RGSKINGS3
 UPC 850015617089
 Min Buy 1 EA



Royal Gold Mendo Mix

Royal Gold Mendo Mix is the king of all coco soils. As a heavily amended planting style mix, Mendo Mix is ideal for outdoor gardening in hot climates and bed style gardens. It also works wonders in traditional container style gardens, indoors or in greenhouses, especially for fast-growing annuals. Featuring a complex blend of high-grade dry amendments, along with strong water holding capacities properly balanced with air holding capacities, Mendo Mix allows gardeners to begin feeding after about four weeks of growth. This allows gardeners the ability to adjust their nutrient profile and feeding regimen, according to their crops specific needs, at the proper time. Mendo Mix is also a great start to building your own living soils program. See for yourself why Mendo Mix rules in the emerald triangle!



1.5cu ft
RGSMENDO15
 UPC 850015617126
 Min Buy 1 EA



Royal Gold Tupur

Royal Gold Tupur, pronounced (two-per), was designed with the idea feeding your plant as much and often as possible. Though not your typical 70/30 coco perlite blend, it is a blank slate to create your own high performance feeding regimen. As a coco fiber based soilless medium, it requires high levels of calcium and magnesium to unlock its true potential. With an astounding balance of oxygen and water holding capacities, Tupur can be watered up to 1-6 times a day! This makes it an ideal choice for automated watering systems, especially drip (drain to waste or recirculating), Ebb and Flow. Even deep water culture, and aquaponics thrive in this unique and versatile blend. Yet it still excels in hand watered container gardens, with organic OR conventional feeding programs. This versatility has been key in Tupur quickly becoming a household name for cultivation experts and enthusiasts from coast to coast.



2cu ft
RGSTUPUR2
 UPC 850015617041
 Min Buy 1 EA
 50L (65/PL)
RGSTUPUR50
 Min Buy 1 EA



Propagation

OASIS® FERTISS® Plant Propagation System

Ready to use plugs in a pre-filled propagation strip. Consistent and even media blend, pH adjusted. The loose, open mix makes it easy to insert and stick cuttings and the uniquely developed trays promote natural air pruning, encouraging development of a dense, fibrous root system. Ideal for slow-to-root cultivars. A long-lasting wetting agent is added to enhance water-holding capabilities. Easy to transplant and transport. Stacked trays do not compress the plug media.



25ct Cell Strip - Plug Size: 3cm x 4cm - Round 1192 Per Pallet Bulk SM5325P

Min Buy 1 PL



OASIS® Rootcubes® Growing Medium Strip

OASIS® Rootcubes® growing medium is manufactured in sheet form, with individual rooting cells shaped like cubes. Rootcubes® are available in sheets of various configurations or liners that fit conveniently into a standard "1020" plastic tray. Crops most commonly propagated from unrooted cuttings in Rootcubes media are poinsettias, geraniums, hibiscus, New Guinea impatiens, fuchsia, foliage, perennials and woody ornamentals. A specialized medium that was designed specifically for a clean, healthy start for unrooted cuttings. Provides the perfect balance of air and water to encourage plant growth and get unrooted cuttings off to a strong start. Contains just the right amount of starter nutrients and are considered an especially economical propagation media.



Medium Strip - 10 Cells per Strip (1 x 10 Configuration)

SM55020

UPC 45744050201

Min Buy 1 CS



Oasis® Terra-Plug

Terra Plug is a bonded media manufactured using a unique horticultural-friendly patented technology. With this technology, a wide variety of media may be used. The Terra Plugs are made by loose filling the propagation trays and stabilizing the media. Plugs do not shrink, are easy to re-water and ready to use. Made for automated processes and easy extraction.



105ct Cell Standard Mix - 37,800 Plugs per Pallet

SM8761105

Min Buy 1 PL

OASIS® HORTICUBES® Growing Medium

A low density, high drainage foam specifically developed for hydroponics seed germination and vegetative propagation of vegetables, herbs, flowers and foliage crops. Allow for an optimal balance of oxygen and water, even when saturated with water. Pre-dibbled holes make it easy to set the seed into place in the media. Single-seed dibble is best for single seeds. The deeper single prong in the hole allows the radical to more quickly penetrate the media leading to fast rooting for single seeds.



1in Thin Cut Medium - 276 Cells per Sheet with Single Seed Dibble - 20 Sheets per Case - Terra Cotta

SM587-22761

Min Buy 1 CS



1in Medium - 162 Cells per Sheet (9 x 18 Configuration)

SM55005

Min Buy 1 CS

1.25in Medium - 104 Cells per Sheet (8 x 13 Configuration)

HYFGMSO5010

UPC 45744050102

Min Buy 1 CS





Growing Media

Terrafibre™ Grow Mats

Using the fibrous byproduct of the industrial hemp plant, we have created Terrafibre™ grow mats. Terrafibre™ grow mats are ideal for microgreens, sprouts, wheatgrass and other short rotation crops. Industrial hemp fibres are separated, cleaned and needle punched to produce a 100% biodegradable soilless growing medium.



10in x 20in - 10pk
BCGGM102010
 UPC 627843845027
 Min Buy 12 EA



5in x 5in - 40pk
BCGGM5540
 UPC 627843845034
 Min Buy 12 EA

Propagation

Terrafibre™ Growing Cubes

Terrafibre growing cubes are a sustainable alternative to rockwool, peat moss or coconut. Hemp is primarily farmed for its seed and the stalk/fibre is traditionally wasted. Through innovative processing and heat sterilization we are able to upcycle the fibres to create a truly sustainable growing media.



1.5in - 9pk
BCGCUBE915
 UPC 627843845072
 Min Buy 44 EA

1.5in - 98pk
BCGCUBE9815
 UPC 627843845089
 Min Buy 16 EA

2in - 4pk
BCGCUBE42
 UPC 628504348109
 Min Buy 36 EA

4in - 6pk
BCGBLOCK46
 UPC 628504348086
 Min Buy 24 EA

4in x 4in - 144bulk
BCGBLOCK4144
 UPC 628504348093
 Min Buy 1 EA



Other

Wiggle Worm Soil Builder™ PURE Worm Castings Organic Fertilizer

100% organic. USE as a FERTILIZER! You only need a small amount around your plants, vegetables, shrubs or grasses to see beautiful yields and growth. A half handful around the root zone of a transplant will produce up to 3-5 times the fruit and plant growth. The nutrients and microbial activity of worm castings produce a "living soil" for your plants to thrive in. With the increased hormone and enzyme growth produced by adding castings to your soil the roots become more fibrous and healthy. A little goes a long way which makes it very cost effective! Manufactured by Unco Industries, Inc. using a proprietary growing and harvesting process that is the only way to guarantee consistently pure castings. Over 40 years of label recognition.



4.5lb
UII602
 UPC 90147439801
 Min Buy 12 EA

15lb
UII603
 UPC 90147135987
 Min Buy 1 EA

30lb (75/PL)
UII604
 UPC 90147269996
 Min Buy 1 EA



All You Need to Grow Good Weed

3 PART GROW SYSTEM FOR 6 TO 8 PLANTS

DRY NUTRIENTS FOR SOIL, VEG, AND FLOWER



Learn More at Reefertilizer.com

O H R S T R O M ' S **maxicrop**

Plants do better with Maxicrop... Naturally.

**Liquid Seaweed | Liquid Seaweed Plus Iron
Liquid Fish | Seaweed Powder | Kelp Meal**

AVAILABLE IN A VARIETY OF SIZES!



To order, please call 1-800-KELP-964

maxicrop.com

INCREASE ROOTS 1000x

BIG FOOT MYCORRHIZAE INCREASES ROOT SURFACE AREA
UP TO 1000X FOR BIGGER, HEALTHIER PLANTS AND
HEALTHIER, HAPPIER CUSTOMERS



SCAN FOR FREE SAMPLES

WWW.BIGFOOTMYCO.COM
@BIGFOOTMYCORRHIZAE



The background of the slide features a top-down view of a laboratory or field setting. In the upper right, a dark-colored tray holds a mound of dark, rich soil. To its left, a patch of bright green moss grows on a grey, textured surface. In the bottom right corner, the silver handles and blades of a pair of scissors are visible. A large, white diamond shape is centered on the slide, framed by a thick, teal-colored border with a thin white inner line.

NUTRIENTS &
Additives



Dry

FoxFarm® Happy Frog® Acid Loving Plants Fertilizer 4-5-3

Happy Frog® Acid Loving Plants Fertilizer is specifically formulated for use on azaleas, rhododendrons, camellias, hydrangeas, evergreens, blueberries, raspberries, strawberries, and all other acid loving plants. This blend of fertilizers and microorganisms delivers nutrition where your plants need it most. Mycorrhizal fungi are included to help increase root efficiency, which may enhance nutrient uptake and water absorption. OMRI Listed® Happy Frog® Fertilizers are Crafted For Organic Gardening™



4lb Bag
FXF500626
 UPC 752289500626
 Min Buy 12 EA

FoxFarm® Happy Frog® All-Purpose Fertilizer 6-4-5

Happy Frog® All-Purpose is a ready-to-use blend of fertilizers and soil microbes that delivers nutrition where your plants need it most. Mycorrhizal fungi are included to help increase root efficiency, which may enhance nutrient uptake and water absorption. Recommended for vegetable gardens, annual and perennial flower gardens, ornamental plantings, and all types of container gardening. OMRI Listed® and Registered CDFA Organic Input Material. Happy Frog®—Crafted For Organic Gardening™



4lb Bag
FXF500541
 UPC 752289500541
 Min Buy 12 EA
50lb (40/PL)
FXF600555
 UPC 752289600555
 Min Buy 1 EA

FoxFarm® Happy Frog® Bone Meal 3-12-0

Happy Frog® Steamed Bone Meal 3-12-0 fertilizer is for all stages of plant growth and flowering. Bone meal is a wonderful food for bulbs and flowers. It is fine-screened and designed to provide phosphorus necessary for all stages of plant growth and flowering. Bone meal also contains calcium which helps support strong cellular development in plants. Mycorrhizal fungi are included to help increase root efficiency, which may enhance nutrient uptake and water absorption. OMRI Listed® and Registered CDFA Organic Input Material. Crafted for organic gardening™.



4lb
FXF600640
 UPC 752289600640
 Min Buy 12 EA

FoxFarm® Happy Frog® Cavern Culture® Fertilizer 1-12-0

Guanos have been used for centuries as fertilizers for all kinds of plants. Happy Frog® Cavern Culture™ Fertilizer is a proprietary blend of bat and seabird guano, rock phosphate and soil microbes that is specially formulated to deliver the nutrition necessary for flowering and bud development. Mycorrhizal fungi are included to help increase root efficiency, which may enhance nutrient uptake and water absorption. Experience the tried-and-true successes of our ancestors with Cavern Culture™ in your own backyard. OMRI Listed® Happy Frog® Fertilizers are Crafted For Organic Gardening™



4lb Bag
FXF500664
 UPC 752289500664
 Min Buy 12 EA
50lb (40/PL)
FXF600678
 UPC 752289600678
 Min Buy 1 EA

FoxFarm® Happy Frog® Citrus & Avocado Fertilizer 7-3-3

Happy Frog® Citrus & Avocado Fertilizer is specially formulated with your citrus and avocado trees in mind. Nothing is better than the juicy, flavorful kick you experience when you taste a fresh lemon or lime, and no one can resist the smooth texture of a perfectly ripened avocado. This formula contains nitrogen for robust vegetative growth, as well as calcium and sulfur to address the needs of these beautiful and bountiful trees. Mycorrhizal fungi are included to help increase root efficiency, which may enhance nutrient uptake and water absorption. Enjoy a burst of delicious goodness when you use Happy Frog® Citrus & Avocado Fertilizer. OMRI Listed® Happy Frog® Fertilizers are Crafted For Organic Gardening™.



4lb Bag
FXF500602
 UPC
 Min Buy

FoxFarm® Happy Frog® Fruit & Flower 4-9-3

Happy Frog® Fruit & Flower Fertilizer is specifically designed to supply phosphorus for fruit and flower development. Also contains nitrogen essential to support growth through the end of the growing season. Mycorrhizal fungi are included to help increase root efficiency, which may enhance nutrient uptake and water absorption. OMRI Listed® Happy Frog® Fertilizers are Crafted For Organic Gardening™



4lb Bag
FXF500527
 UPC 752289500527
 Min Buy 12 EA
50lb Bag (40/PL)
FXF600531
 UPC 752289600531
 Min Buy 1 EA



Dry

FoxFarm® Happy Frog® Japanese Maple Fertilizer 4-3-4

Happy Frog® Japanese Maple Fertilizer is specifically formulated for use on Japanese maples, lilies, evergreens, hydrangeas, junipers, dogwoods, flowering ornamentals, and other low pH feeders. This unique blend of fertilizers and microorganisms delivers nutrition where your plants need it most. Contains phosphorus and potassium to support the needs of these beautiful trees. Mycorrhizal fungi are included to help increase root efficiency, which may enhance nutrient uptake and water absorption. OMRI Listed® and Registered CDFA Organic Input Material. Happy Frog®—Crafted For Organic Gardening™



4lb Bag

FXF500565

UPC 752289500565

Min Buy 12 EA

FoxFarm® Happy Frog® Jump Start Fertilizer 3-4-3

Happy Frog® Jump Start Fertilizer is formulated for use on transplanted seedlings and re-potted container plants. This proprietary mix of fertilizers supplies phosphorus, a nutrient necessary for the early stages of plant growth. It also contains calcium which may help build stronger cell walls and boost the plant's ability to resist disease. Mycorrhizal fungi are included to help increase root efficiency, which may enhance nutrient uptake and water absorption. OMRI Listed® and Registered CDFA Organic Input Material. Happy Frog®—Crafted For Organic Gardening™



4lb Bag

FXF500589

UPC 752289500589

Min Buy 12 EA

FoxFarm® Happy Frog® Tomato & Vegetable Fertilizer 5-7-3

Happy Frog® Tomato & Vegetable Fertilizer is specifically formulated for use on all veggies, tomato varieties, soft fruits and berries. The nitrogen, phosphorus and potassium in this blend supply the nutrition necessary to support the vegetative and flowering stages of plant growth. This fertilizer also contains calcium which helps prevent blossom end rot and builds stronger cell walls, boosting the plants ability to resist disease. Mycorrhizal fungi are included to help increase root efficiency, which may enhance nutrient uptake and water absorption. OMRI Listed® Happy Frog® Fertilizers are Crafted For Organic Gardening™



4lb Bag

FXF500503

UPC 752289500503

Min Buy 12 EA

50lb (40/PL)

FXF600517

UPC 752289600517

Min Buy 1 EA

Dry

FoxFarm® Marine Cuisine® Slow Release Fertilizer 10-7-7

Marine Cuisine® is an all-purpose fertilizer that blends ocean-based ingredients like crab meal, shrimp meal, seabird guano, and kelp with mineral plant foods to give your garden a quick boost and provide long-lasting, slow release nutrition. Marine Cuisine® is designed for flowers and vegetable gardens, ornamental trees and shrubs, fruit trees, roses, container plants, and lawns. Marine Cuisine® is truly Seafood for your Garden!™



4lb Bag

FXF790393

UPC 752289790393

Min Buy 8 EA

50lb (40/PL)

FXF790430

UPC 752289790430

Min Buy 1 EA

Water Soluble

FoxFarm® Soluble Fertilizer Trio Pack

Invite the whole family over. We designed our solubles to work together as part of a sequential feeding schedule for hydroponic and conventional growers. Using our soluble plant foods on your plants is like putting your plants on an Olympic training diet. Check out Open Sesame®, Beastie Bloomz® and Cha Ching®, and see the results for yourself! For best results, start indoor plants in our Light Warrior® Agro-Ponic® Grow Medium, and use our Ocean Forest® Potting Soil for container plants.



3pk - 1lb each

FXF502002

UPC 752289502002

Min Buy 6 EA

FoxFarm® Cultivation Nation® Flower 4-35-26

Cultivation Nation® Flower is step two of our Cultivation Nation® 2-Part Soluble Feeding Program. Use it during the mid to late stages of the flowering cycle through harvest to support fruit and bud development.



1lb

FXF260636

UPC 752289260636

Min Buy 12 EA

15lb

FXF260124

UPC 752289260124

Min Buy 1 EA

50lbs

FXF260131

UPC 752289260131

Min Buy 1 EA





Water Soluble

FoxFarm® Cultivation Nation® Veggie 24-14-11

Cultivation Nation® Veggie is step one of our Cultivation Nation® 2-Part Soluble Feeding Program. It contains a blend of immediately available nutrients that are formulated to enhance plant size and structure. Use Cultivation Nation® Veggie during the vegetative growth cycle, and switch to Cultivation Nation® Flower during the middle to late stages of fruiting and flowering through harvest.



1lb
FXF260629
 UPC 752289260629
 Min Buy 12 EA

15lb
FXF260100
 UPC 752289260100
 Min Buy 1 EA

50lbs
FXF260117
 UPC 752289260117
 Min Buy 1 EA



Water Soluble

FoxFarm® Open Sesame® Soluble Fertilizer 5-45-19

Open Sesame® is a high-phosphorus soluble fertilizer that's designed for use during the early weeks of flowering to support vigorous blooming and bud development.



6oz
FXF201530
 UPC 752289201530
 Min Buy 12 EA

1lb
FXF201639
 UPC 752289201639
 Min Buy 1 EA

2lb Soluble
FXF201738
 UPC 752289201738
 Min Buy 1 EA

15lb
FXF201745
 UPC 752289201745
 Min Buy 1 EA



FoxFarm® Beastie Bloomz® Fertilizer 0-50-30

Beastie Bloomz® is a high-phosphorus soluble fertilizer specially formulated to support blossom development during mid to late flowering. For use in soilless mixes, soils, hydroponics, and aeroponic systems.



6oz
FXF501319
 UPC 752289501319
 Min Buy 12 EA

1lb
FXF501418
 UPC 752289501418
 Min Buy 1 EA

2lb
FXF501517
 UPC 752289501517
 Min Buy 1 EA

15lb
FXF501616
 UPC 752289501616
 Min Buy 1 EA



Liquid

FoxFarm® Dirty Dozen® Liquids & Solubles Starter Pack

FoxFarm Dirty Dozen® is a force to be reckoned with! Twelve of our fiercest warriors will put your garden in the spotlight. FoxFarm Dirty Dozen® Starter Pack contains nine pint liquids: Kangaroots®, Microbe Brew®, Bembé®, SledgeHammer®, Flowers Kiss®, Boomerang®, Big Bloom®, Tiger Bloom® and Grow Big®, & three 6-Ounce solubles: Open Sesame®, Beastie Bloomz® and Cha Ching®.



12pcs
FXF301209
 UPC 752289301209
 Min Buy 2 EA



FoxFarm® Cha Ching® Fertilizer 9-50-10

Every stage of the growing cycle demands optimal nutrition. Cha Ching® is a high-phosphorus fertilizer that is designed to help support late stage fruiting processes. Even better, we've included the micronutrient package that FoxFarm is known for.



6oz
FXF501333
 UPC 752289501333
 Min Buy 12 EA

1lb Jar
FXF501432
 UPC 752289501432
 Min Buy 1 EA

2lb Jar
FXF501531
 UPC 752289501531
 Min Buy 1 EA

15lb Jar
FXF501548
 UPC 752289501548
 Min Buy 1 EA



FoxFarm® Bush Doctor® Bembé® Fertilizer 0-1-3

From the deepest jungles of the African Congo comes the word "Bembé" which means Sweet Offering. Bush Doctor® Bembé® is a liquid concentrate that is precisely created with a complex array of sugars and nutrients. When used as directed, Bembé® can help plants achieve enhanced sweetness qualities, while providing a food source for the microbial populations at the root zone.



16oz Concentrate
FXF794056
 UPC 752289794056
 Min Buy 1 EA

32oz Concentrate
FXF791055
 UPC 752289791055
 Min Buy 1 EA

1gal
FXF791062
 UPC 752289791062
 Min Buy 1 EA





Liquid

FoxFarm® Bush Doctor® Cal-Mag Supplement 1-0-0, 3% Calcium 0.9% Magnesium

Nobody likes blossom end rot or tip burn. That's why FoxFarm brings you Bush Doctor® Cal-Mag. Calcium and magnesium help strengthen cell walls and aid in fruit development, helping you avoid the costly and frustrating deficiencies that cause these problems. OMRI Listed® and CDFA Registered for Organic Gardening.



1pt
FXF520075
 UPC 752289520075
 Min Buy 12 EA



1gal
FXF520099
 UPC 752289520099
 Min Buy 4 EA



1qt
FXF520082
 UPC 752289520082
 Min Buy 12 EA

FoxFarm® Bush Doctor® Boomerang® 2-0.2-0.3

Even Mother Nature needs a little help sometimes! Boomerang® lends a hand when the stresses of temperature fluctuations, unintentional neglect, and mineral salt build up knock your beauties down for the count. The soil microbes in Boomerang® help support the root zone. Boomerang® can also be used as a vegetative supplement. It contains solubilized nutrition that is immediately available to plants.



16oz Concentrate
FXF793851
 UPC 752289793851
 Min Buy 1 EA

1gal
FXF790867
 UPC 752289790867
 Min Buy 1 EA



32oz
FXF790850
 UPC 752289790850
 Min Buy 1 EA

FoxFarm® Bush Doctor® Flowers Kiss® Fertilizer 1-0.30-0.05

Survival of the fittest is a way of life in the rainforest. Layer upon layer of giants lift their foliage to the sky where sunlight, water and nutrients can be claimed. Bush Doctor® Flowers Kiss® spray-on foliar plant food is designed to be easily absorbed through the plant's leaves, like a soft rain, providing nutrition from the top down.



16oz
FXF793950
 UPC 752289793950
 Min Buy 1 EA

1gal
FXF790966
 UPC 752289790966
 Min Buy 1 EA



32oz
FXF790959
 UPC 752289790959
 Min Buy 1 EA



FoxFarm® Bush Doctor® Kangaroos® Fertilizer 0.8-0.1-0.03

Bush Doctor Kangaroos® is a liquid root drench formulation designed to enhance root efficiency in the rhizosphere. Kangaroos® contains nutrients which are immediately available to plants. Kangaroos® also contains soil microbes to support the root zone and help plants achieve enhanced nutrient uptake. Kangaroos® supplies essential macro and micronutrients that can help plants thrive. For use in both hydroponic and soil applications. For best results, follow the FoxFarm feeding schedule.



16oz Concentrate
FXF793769
 UPC 752289793769
 Min Buy 1 EA

1gal
FXF790775
 UPC 752289790775
 Min Buy 1 EA



32oz Concentrate
FXF790768
 UPC 752289790768
 Min Buy 1 EA

FoxFarm® Bush Doctor® Kelp Me Kelp You® 0.5-0-0.5

Kelp grows higher than even some of the Earth's trees. The teeming aquatic life that flourishes in a kelp bed has just as much diversity as that of a rainforest. Kelp Me Kelp You® is a seaweed plant food derived from Ascophyllum nodosum and designed for use in organic gardening. Our product is a liquid concentrate that can be used for growing fruits, vegetables, gardens or flowers. Suitable for use in gardens, drip-irrigation systems or hydroponic applications. OMRI Listed® and Registered CDFA Organic Input Material. Kelp Me Kelp You® is a seaweed extract derived from Ascophyllum nodosum and can be used for growing fruits, vegetables, gardens, flowers and in drip-irrigation systems or hydroponic applications. OMRI Listed® and Registered CDFA Organic Input Material.



16oz Concentrate
FXF794209
 UPC 752289794209
 Min Buy 1 EA

32oz
FXF791208
 UPC 752289791208
 Min Buy 1 EA



1gal
FXF791215
 UPC 752289791215
 Min Buy 1 EA



Liquid

**FoxFarm® Bush Doctor® Liquid Iron
Micro-Nutrient 1-0-0**

Give your plants a shot at greatness with Bush Doctor® Liquid Iron! Iron is essential to plant growth, playing a vital role in green up, energy production, and nitrogen fixation. For use on trees, shrubs, citrus and roses. OMRI Listed® and Registered CDFA Organic Input Material. Prepare Your Plants To Perform!



16oz Concentrate

FXF520044

UPC 752289520044

Min Buy 12 EA

32oz

FXF520051

UPC 752289520051

Min Buy 12 EA

1gal

FXF520068

UPC 752289520068

Min Buy 4 EA

FoxFarm® Don't Bug Me® Insect Spray

Don't Bug Me® Home and Garden Insect Spray may be used indoors or outdoors as a contact spray for flying and crawling pests commonly found in and around the home. Don't Bug Me® Home and Garden Insect Spray contains Pyrethrum, derived from a Chrysanthemum flower, to give fast and effective kill on contact. Pyrethrum will also "flush" hiding insects, which then allows you to spray them for immediate contact kill.



24oz Ready to Use

FXF790508

UPC 752289790508

Min Buy 12 EA



**FoxFarm® Bush Doctor® Manganese
Micro-Nutrient 1-0-0**

You probably think you've covered all your bases: your NPK is on point, your pH is dialed in, and there isn't a pest in sight. Sounds good, but did you know that plants without Manganese can suffer? This important micronutrient plays a valuable role in photosynthesis and helps plants hold their own against environmental stresses. OMRI Listed® and Registered CDFA Organic Input Material.



16oz

FXF520013

UPC 752289520013

Min Buy 12 EA

32oz

FXF520020

UPC 752289520020

Min Buy 12 EA

1gal

FXF520037

UPC 752289520037

Min Buy 4 EA

**FoxFarm® Bush Doctor® Microbe Brew® Microbial
Inoculant 1-0.3-0.2**

Bush Doctor® Microbe Brew® is a liquid microbial inoculant with a complex blend of ingredients specially formulated to help plants achieve enhanced root efficiency and nutrient uptake. Microbe Brew® encourages rapid microbial colonization at the root zone and can be used in both hydroponic and soil applications. Use Microbe Brew® on your ornamental flowers, evergreens, vegetables and trees.



16oz Concentrate

FXF793714

UPC 752289793714

Min Buy 1 EA

32oz

FXF790713

UPC 752289790713

Min Buy 1 EA

1gal

FXF790720

UPC 752289790720

Min Buy 1 EA



FoxFarm® Bush Doctor® Sledge Hammer®

Bush Doctor® SledgeHammer® encourages water movement through soil and soilless media. High fertilizer use can compromise plant growth over time due to concentrated mineral salt deposits. SledgeHammer® is a unique rinse formula designed to remove fertilizer buildup which may relieve nutrient lockout. Derived from saponin, an extract of the Yucca schidigera plant. SledgeHammer® is designed for organic gardening and can be used for both hydroponic and soil applications. OMRI Listed® and Registered CDFA Organic Input Material.



16oz Concentrate

FXF793806

UPC 752289793806

Min Buy 1 EA

32oz

FXF790805

UPC 752289790805

Min Buy 1 EA

1gal

FXF790812

UPC 752289790812

Min Buy 4 EA



Liquid

FoxFarm® Bush Doctor® Wholly Mackerel® 3-1-0

Bush Doctor Wholly Mackerel® is a liquid plant nutrient derived from fish. Wholly Mackerel® provides immediately available nutrition to support vigorous growth. Registered CDFA Organic Input Material.



16oz Concentrate

FXF794308

UPC 752289794308

Min Buy 1 EA

32oz

FXF791307

UPC 752289791307

Min Buy 1 EA

1gal

FXF791314

UPC 752289791314

Min Buy 1 EA



FoxFarm® Cultivation Nation® Grow 2-1-6

Cultivation Nation® Grow Fertilizer is part one in our 3-part liquid feeding program. Start with Cultivation Nation® Grow for vegetative growth, then supplement with Cultivation Nation® Micro and finish strong with Cultivation Nation® Bloom.



1pt

FXF260179

UPC 752289260179

Min Buy 12 EA

1qt

FXF260186

UPC 752289260186

Min Buy 12 EA

1gal

FXF260193

UPC 752289260193

Min Buy 4 EA

2.5gal

FXF260209

UPC 752289260209

Min Buy 2 EA

5gal

FXF260148

UPC 752289260148

Min Buy 1 EA

15gal

FXF260018

UPC 752289260018

Min Buy 1 EA



FoxFarm® Cultivation Nation® Micro 5-0-1

Cultivation Nation® Micro Fertilizer is part two in our 3-part liquid feeding program. Begin by introducing Cultivation Nation® Grow Fertilizer, then supplement with Cultivation Nation® Micro to supply your plants with important micronutrients, and finish strong with Cultivation Nation® Bloom Liquid Fertilizer.



1qt

FXF260223

UPC 752289260223

Min Buy 12 EA

1pt

FXF260216

UPC 752289260216

Min Buy 12 EA

1gal

FXF260230

UPC 752289260230

Min Buy 4 EA

2.5gal

FXF260247

UPC 752289260247

Min Buy 2 EA

5gal

FXF260155

UPC 752289260155

Min Buy 1 EA

15gal

FXF260049

UPC 752289260049

Min Buy 1 EA



FoxFarm® Cultivation Nation® Bloom 0-5-4

Cultivation Nation® Bloom Fertilizer is part three in our 3-part liquid feeding program. Begin by introducing Cultivation Nation® Grow and Micro into your feeding program, and then transition to Cultivation Nation® Bloom Fertilizer at the first sign of bud development through harvest.



1pt

FXF260254

UPC 752289260254

Min Buy 12 EA

1qt

FXF260261

UPC 752289260261

Min Buy 12 EA

1gal

FXF260278

UPC 752289260278

Min Buy 4 EA

2.5gal

FXF260285

UPC 752289260285

Min Buy 2 EA

5gal

FXF260162

UPC 752289260162

Min Buy 1 EA

15gal

FXF260070

UPC 752289260070

Min Buy 1 EA



FoxFarm® Liquid Nutrient Trio Soil Formula Fertilizer

Put it all together! Our customers asked for a three-pack of their favorite liquid fertilizers, and here it is: Big Bloom®, Grow Big®, and Tiger Bloom®, together at last. Designed to work together to support vigorous growth, multiple bud development and abundant fruit.



3pk - 32oz each

FXF791000

UPC 752289791000

Min Buy 4 EA



FoxFarm® Big Bloom® Fertilizer 0-0.5-0.7

Our Big Bloom® Liquid Plant Food is a carefully selected blend of fertilizers formulated to support multiple blooms and seed formations. This liquid plant food supplies nutrients that your plants can access immediately. Big Bloom® contains bat guano and earthworm castings. Bat guano has been used for centuries as a fertilizer for all kinds of plants. Combined with earthworm castings they create a nutrient-rich mix that can help your plants thrive. OMRI Listed® and Registered CDFA Organic Input Material.



16oz Concentrate

FXF793103

UPC 752289793103

Min Buy 12 EA

32oz Concentrate

FXF790102

UPC 752289790102

Min Buy 12 EA

1gal Concentrate

FXF790904

UPC 752289790904

Min Buy 4 EA

2.5gal

FXF790911

UPC 752289790911

Min Buy 2 EA

5gal

FXF790928

UPC 752289790928

Min Buy 1 EA

15gal

FXF802119

UPC 752289802119

Min Buy 1 EA





Liquid

FoxFarm® Grow Big® Fertilizer 6-4-4

Get your garden going with Grow Big®, our liquid concentrate fertilizer that supports lush vegetative growth. Our special brew is designed to enhance plant size and structure, allowing for more abundant fruit, flower and bud development. It is formulated with a low pH to maintain stability in storage and keep micronutrients available.



16oz Concentrate

FXF793202

UPC 752289793202

Min Buy 12 EA

32oz Concentrate

FXF790201

UPC 752289790201

Min Buy 12 EA

1gal Concentrate

FXF790300

UPC 752289790300

Min Buy 1 EA

2.5gal Concentrate

FXF790317

UPC 752289790317

Min Buy 2 EA

5gal Concentrate

FXF790331

UPC 752289790331

Min Buy 1 EA

15gal

FXF802126

UPC 752289802126

Min Buy 1 EA



FoxFarm® Grow Big® Hydroponic Fertilizer 3-2-6

Based on our popular Grow Big® Liquid Plant Food, Grow Big® Hydroponic Liquid Plant Food is a liquid concentrate fertilizer specifically designed for hydroponic use. Grow Big® Hydroponic contains earthworm castings, kelp and essential micronutrients to support vigorous vegetative growth.



16oz Concentrate

FXF793219

UPC 752289793219

Min Buy 12 EA

32oz Concentrate

FXF790218

UPC 752289790218

Min Buy 12 EA

1gal Concentrate

FXF790232

UPC 752289790232

Min Buy 4 EA

2.5 Gallon Concentrate

FXF790249

UPC 752289790249

Min Buy 2 EA

5gal Concentrate

FXF790256

UPC 752289790256

Min Buy 1 EA



FoxFarm® Cultivation Nation® pH Up Raises Nutrient Solution

It's time to get on UP! Use Cultivation Nation® pH UP to raise the pH of your nutrient solution in both soil and hydroponic environments.



16oz

FXF270109

UPC 752289270109

Min Buy 12 EA

1qt

FXF270116

UPC 752289270116

Min Buy 12 EA



FoxFarm® Cultivation Nation® pH Down Lowers Nutrient Solution

It's time to get down! Use Cultivation Nation® pH DOWN to lower the pH of your nutrient solution in both soil and hydroponic environments.



1pt

FXF270130

UPC 752289270130

Min Buy 12 EA

1qt

FXF270147

UPC 752289270147

Min Buy 12 EA

1gal

FXF270154

UPC 752289270154

Min Buy 4 EA



FoxFarm® Tiger Bloom® Fertilizer 2-8-4

FoxFarm Tiger Bloom® is a phosphorus fertilizer that contains nitrogen to support vigorous growth. It is formulated with a low pH to maintain stability in storage and keep micronutrients available. Tiger Bloom® can be used for both hydroponic and soil applications. Tiger Bloom® is designed to encourage abundant fruit, flower, and multiple bud development. Use Tiger Bloom® at the first signs of flowering through harvest.



16oz Concentrate

FXF793226

UPC 752289793226

Min Buy 12 EA

32oz Concentrate

FXF790225

UPC 752289790225

Min Buy 12 EA

1gal Concentrate

FXF790324

UPC 752289790324

Min Buy 4 EA

2.5gal Concentrate

FXF790348

UPC 752289790348

Min Buy 2 EA

5gal Concentrate

FXF790355

UPC 752289790355

Min Buy 1 EA

15gal Concentrate

FXF802140

UPC 752289802140

Min Buy 1 EA





Water Soluble

Jack's Classic® All Purpose 20-20-20

Balanced nitrogen, phosphorous and potassium with nutrients for all indoor and outdoor plants. Feeds both the roots and the leaves. Comes in a plastic tub with water resistant label.



8oz

JRP52008

UPC 671341520085

Min Buy 12 EA

10lb

JRP52010

UPC 671341520108

Min Buy 1 EA



Jack's Classic® Blossom Booster 10-30-20

Professional formula for more flowers and brighter colors on all outdoor and indoor plants. Includes micronutrients, too. Comes in a plastic tub with water resistant label.



4lb

JRP51064

UPC 671341510642

Min Buy 6 EA



Jack's Nutrients BOOST 15-0-0 Cal-Trate

Cal-Trate addresses specific crop and water needs by supplying calcium and nitrogen as well as a balanced micronutrient package. This formula will provide a boost of calcium while maintaining micronutrient targets.



25lb (80/PL)

JRP79170

UPC 671341791706

Min Buy 1 BG



Jack's Professional® Epsom Salt

An essential item to the Jack's® 3-2-1 program.



1kg, 6/cs

JRP79161

Min Buy 6 EA

25lb (80/PL)

JRP79160

Min Buy 1 EA



Jack's® Nutrients 15-0-0 Calcium Nitrate Part B Fertilizer

Promotes Calcium uptake and strong leaf growth. BOOST 15-0-0 is a pure combination of a calcium and nitrate nitrogen allowing growers flexibility to boost their levels according to different crops or stages of growth. Used in combination with Jack's Part A FeED, these two products combined to make a totally available nutrient solution.



1Kg (2.2lb)

JRP79081

UPC 671341790815

Min Buy 1 BG

25lb (80/PL)

JRP79080

UPC 671341790808

Min Buy 1 BG



Jack's® Nutrients 5-12-26 Part A Fertilizer

Promotes the growth of leaves and strong roots. Blended with purely soluble and available nutrients to allow the grower maximum flexibility. Specific mixtures of macro, secondary and micronutrients deliver an efficient combination of nutrients suitable for many different growing environments and crop types.



1Kg (2.2lb)

JRP79031

UPC 671341790310

Min Buy 1 BG

25lb (80/PL)

JRP79030

UPC 671341790303

Min Buy 1 BG



Jack's® Nutrients 10-30-20 Bloom Fertilizer

Promotes root growth plus flower and fruit development. This 1:3:2 major nutrient ratio combination promotes blooming resulting in enhanced flower buds and fruit sets. Proven and trusted by professional growers for over 70 years.



1Kg (2.2lb)

JRP79061

UPC 671341790617

Min Buy 1 BG

25lb (80/PL)

JRP79060

UPC 671341790600

Min Buy 1 BG



Jack's® Nutrients 12-4-16 Fertilizer

Nutrient uptake in pure and reverse osmosis waters. Designed to provide a highly soluble NPK plus and enhanced micronutrient package along with 7% Calcium and 2% soluble magnesium to help replace the nutrients that are missing from pure water and RO filter water types.



1Kg (2.2lb)

JRP79041

UPC 671341790419

Min Buy 1 BG

25lb (80/PL)

JRP79040

UPC 671341790402

Min Buy 1 BG





Water Soluble

Jack's® Nutrients 15-5-20 Water Fertilizer

Promotes growth of leaves and strong roots. Allow your plants to drink this formula designed to provide all the macro, secondary and micro nutrients on a one-part system. Specifically formulated for alkaline tap, city or well water types. This potentially acidic formula will lower pH over time without forgetting the extra soluble Ca, Mg and the right amount of micronutrients.



1Kg (2.2lb)

JRP79051

UPC 671341790518

Min Buy 1 BG

25lb (80/PL)

JRP79050

UPC 671341790501

Min Buy 1 BG

**Jack's® Nutrients 15-6-17 Clone Starter Fertilizer**

Promotes fast root development and extensive root system growth. Best used for fertilizing young seedlings, transplants, clones and newly set root cuttings.



1Kg (2.2lb)

JRP79071

UPC 671341790716

Min Buy 1 BG

25lb (80/PL)

JRP79070

UPC 671341790709

Min Buy 1 BG

**Jack's® Nutrients 5-50-18 UltraViolet Fertilizer**

Promotes Bud Set & Enhanced Flower Production. Get ready for a serious boost of available phosphorus. The primary goal of this formula is to assist in shutting down the strong vegetative growth stage of the plant and promote the switch to reproductive or flowering phase of plant and flower development.



1Kg (2.2lb)

JRP79011

UPC 671341790112

Min Buy 1 BG

25lb (80/PL)

JRP79010

UPC 671341790105

Min Buy 1 BG

**Jack's® Nutrients 7-15-30 Finish Fertilizer**

Promotes strong finished plants. You have always been told to finish strong. This formula is ideally formulated for this purpose to provide your plants with low N, high P and high K content to keep the whole plant happy to the end of its crop cycle.



1Kg (2.2lb)

JRP79021

UPC 671341790211

Min Buy 1 BG

25lb (80/PL)

JRP79020

UPC 671341790204

Min Buy 1 BG

**Jack's Professional® 20-20-20 General Purpose Fertilizer**

Great for maintaining plants in garden center and growing facilities. It provides fast green-up and great foliar expansion due to the high percentage of ammonium and urea nitrogen plus balanced phosphorus and potassium for excellent root and shoot growth.



25lb (80/PL)

JRP77010

UPC 671341770107

Min Buy 1 BG

**Jack's Professional® 16-4-17 Oasis Hydroponic FeED Fertilizer**

An innovative formula that provides all the macro, secondary and micronutrients in a one-part system. Designed specially for hydroponically grown herbs (basil, cilantro, chives, parsley etc.), as well as, lettuce and most vegetables. Includes our proprietary blend of iron chelates that keeps iron available even as the pH varies up to a high of 8.0.



25lb

JRP71750

UPC 671341717508

Min Buy 1 BG

**Jack's Elementals® Calcium Chloride Dihydrate**

Calcium Chloride can be used to correct a calcium deficiency detected by growing media or foliar analysis. It is most commonly used as a foliar application.



25lb

JRP74371

Min Buy 1 BG





Dry

Down To Earth™ Acid Mix 4-3-6

A fertilizer blended specifically for acid soil loving plants like rhododendrons, azaleas, hydrangeas, evergreen trees and shrubs, blueberries, raspberries and other plants that thrive in a low pH soil. To encourage lush flowers and fruit, apply Acid Mix in early Spring for vegetative growth and again when blooms appear. Fall applications promote healthy root growth and boost resistance to extreme winter temperatures.



- | | |
|--|--|
| 1lb
DTE17803
UPC 714360178032
Min Buy 12 EA | 25lb (40/PL)
DTE03227
UPC 714360032273
Min Buy 1 EA |
| 5lb
DTE07824
UPC 714360078240
Min Buy 6 EA | 50lb (40/PL)
DTE03230
UPC 714360032303
Min Buy 1 EA |



Down To Earth™ All Purpose Mix 4-6-2

A gentle, non-burning fertilizer perfect for vegetables, herbs, flowers and container plants, our All Purpose mix is also ideal for all types of transplants. Formulated with top quality organic ingredients and designed to deliver a steady supply of essential nutrients to your plants while enhancing soil fertility and microbial activity naturally. Our best selling fertilizer!



- | | |
|--|--|
| 1lb
DTE17801
UPC 714360178018
Min Buy 12 EA | 25lb (40/PL)
DTE01942
UPC 714360019427
Min Buy 1 EA |
| 5lb
DTE07806
UPC 714360078066
Min Buy 6 EA | 50lb (40/PL)
DTE01941
UPC 714360019410
Min Buy 1 EA |
| 15lb
DTE15806
UPC 714360158065
Min Buy 1 EA | |



Down To Earth™ Bio-Fish 7-7-2

A nutrient rich fertilizer ideal for heavy feeders like corn, cole crops and tomatoes, Bio-Fish is loaded with the finest marine based ingredients to improve your soil while nourishing your outdoor plants. An excellent source of nitrogen and phosphorus, Bio-Fish can be used throughout the growing season to promote vigorous growth, beautiful blooms and plentiful fruit.



- | | |
|--|--|
| 5lb
DTE07842
UPC 714360078042
Min Buy 6 EA | 50lb (40/PL)
DTE03499
UPC 714360035007
Min Buy 1 EA |
| 25lb (40/PL)
DTE03502
UPC 714360035014
Min Buy 1 EA | |



Down To Earth™ Bio-Live™ 5-4-2

Bio-Live™ is a rich, organic fertilizer mix infused with a generous amount of beneficial bacteria and mycorrhizal fungi to stimulate rooting, vigor and optimum plant development. Bio-Live encourages rapid colonization of soil and soil less mixes and may be combined with other DTE fertilizers to further improve plant growth and yields.



- | | |
|--|--|
| 5lb
DTE07828
UPC 714360078288
Min Buy 6 EA | 50lb (40/PL)
DTE01925
UPC 714360019250
Min Buy 1 EA |
| 25lb (40/PL)
DTE01924
UPC 714360019243
Min Buy 1 EA | |



Down To Earth™ Bio-Turf™ 8-3-5

Down To Earth™ Bio-Turf™ 8-3-5 is an entirely natural granular lawn fertilizer designed to encourage deep root development to help reduce watering requirements. DTE™ Bio-Turf's™ nitrogen-rich formula boosts early season growth while its extra Potassium reduces seasonal stress due to temperature change and drought.



- | |
|---|
| 6lb
DTE07833
UPC 714360078332
Min Buy 6 EA |
|---|



Down To Earth™ Citrus Mix™ 6-3-3

Designed to nourish citrus trees in home orchards and containers, our Citrus Mix™ is formulated with primary and secondary plant nutrients plus selected micronutrients that promote lush new growth, abundant green foliage, fragrant blossoms and bountiful fruit. It may also be used to feed other fruit trees, vines and ornamentals for equally enjoyable results.



- | | |
|--|--|
| 1lb
DTE17863
UPC 714360178636
Min Buy 12 EA | 25lb (40/PL)
DTE01363
UPC 714360013630
Min Buy 1 EA |
| 5lb
DTE07863
UPC 714360078639
Min Buy 6 EA | 50lb (40/PL)
DTE01563
UPC 714360015634
Min Buy 1 EA |
| 15lb
DTE15863
UPC 714360158638
Min Buy 1 EA | |



Down To Earth™ Fruit Tree 6-2-4

Down To Earth Fruit Tree is designed for the delicious and nutritious tree fruits now popular in many backyard gardens. Down To Earth's Fruit Tree fertilizer provides primary nutrients for plant growth plus added calcium for proper fruit development, so you can enjoy bountiful crops of home grown fruit. From apples, pears and plums to mangos, pomegranates and figs, Fruit Tree can be used on all varieties of fruiting canes, shrubs and trees.



- | |
|---|
| 5lb
DTE07849
UPC 714360078493
Min Buy 6 EA |
|---|





Dry

Down To Earth™ Rose & Flower Mix 4-8-4

A special fertilizer blend that provides ample nitrogen for vigorous growth, extra Phosphorous for beautiful blooms and Potassium and trace elements for healthy plant stock. Our Rose & Flower Mix supplies your favorite bulbs, annuals and perennials with the nutrients needed for a long, healthy season of sensational flowering.



5lb
DTE07820
 UPC 714360078202
 Min Buy 6 EA



Down To Earth™ Starter Mix 3-3-3

Starter and transplant formula, is the perfect way to get your delicate young starts and new seedlings in the ground and ready to thrive. In addition to essential primary and secondary plant nutrients we've added a beneficial mix of endomycorrhizal fungi to ensure successful planting, expansive root development and vigorous early growth. Use Starter Mix throughout the growing season when transplanting, preparing seed starting soil mixes and for container grown flowers, herbs and vegetables.



1lb
DTE17836
 UPC 714360178360
 Min Buy 12 EA

25lb (40/PL)
DTE01325
 UPC 714360013258
 Min Buy 1 EA

5lb
DTE07836
 UPC 714360078363
 Min Buy 6 EA

50lb (40/PL)
DTE01350
 UPC 714360013500
 Min Buy 1 EA



Down To Earth™ Vegan Mix 3-2-2

The indispensable all purpose fertilizer blended specially for vegan gardeners. Free of any animal products or by-products, Vegan Mix is formulated with plant derived essential nutrients and natural mineral elements plus humic acids. Its slow release formula is designed to continually nourish your vegetables, flowers and herbs while stimulating and building soil health.



5lb
DTE07821
 UPC 714360078219
 Min Buy 6 EA

50lb (40/PL)
DTE03250
 UPC 714360032501
 Min Buy 1 EA

25lb (40/PL)
DTE03225
 UPC 714360032259
 Min Buy 1 EA



Down To Earth™ Vegetable Garden 4-4-4

Down To Earth Vegetable Garden 4-4-4 is full of powerful plant nutrition to help your garden grow! Its all-purpose formulation provides a perfect start for your sprightly spring veggies, gives your summer tomatoes super-powers and is fantastic for growing your favorite fragrant herbs.



1lb
DTE17854
 UPC 714360178544
 Min Buy 12 EA



5lb
DTE07854
 UPC 714360078547
 Min Buy 6 EA



Down To Earth™ Alfalfa Meal 2.5-0.5-2.5

An excellent soil conditioner, Alfalfa Meal is a rich source of trace elements and natural growth stimulants. Recommended for all flowering plants and especially roses, Alfalfa Meal accelerates growth and promotes larger, more plentiful blooms. It is also useful as a compost bio-activator due to its high organic matter content and ideal Carbon-to-Nitrogen ratio.



.5lb
DTE17805
 UPC 714360178056
 Min Buy 12 EA

25lb (40/PL)
DTE25682
 UPC 714360256822
 Min Buy 1 EA

4lb
DTE07885
 UPC 71436007885
 Min Buy 6 EA



Down To Earth™ AZOMITE® Granulated

The "A to Z of Minerals Including Trace Elements" is a mined volcanic mineral product that has been granulated for easy application. An excellent way to re-mineralize depleted garden soils, composts or potting mediums, AZOMITE® is proven to increase crop yield, quality and overall plant growth.



5lb - Granular
DTE07860
 UPC 714360078608
 Min Buy 6 EA

50lb - Granular (40/PL)
DTE47040
 UPC 714360470402
 Min Buy 1 EA



Down To Earth™ AZOMITE® SR Powder

Slow-Release grade of AZOMITE® volcanic minerals with particle sizes ranging from 4 to 200 mesh. Ideal for blending with other fertilizers and amendments as a trace mineral resource to help meet plant nutritional needs. An economical way to fortify and re-mineralize soils, composts.



1lb
DTE17804
 UPC 714360178049
 Min Buy 12 EA

50lb (40/PL)
DTE47140
 UPC 714360471409
 Min Buy 1 EA





Dry

Down To Earth™ Bat Guano 7-3-1

The undisputed champion of organic fertilizers, Bat Guano 7-3-1 is rich in readily available Nitrogen, Phosphorus and Micronutrients providing essential plant nutrition for vigorous vegetative growth and early fruit and flower development. OMRI listed.



- | | |
|--|--|
| .25lb
DTE17887
UPC 714360178872
Min Buy 12 EA | 10lb (50/PL)
DTE02787
UPC 714360027873
Min Buy 1 EA |
| 2lb
DTE07887
UPC 714360078875
Min Buy 6 EA | 25lb (40/PL)
DTE12787
UPC 714360127870
Min Buy 1 EA |

Down To Earth™ Cottonseed Meal 6-2-1

The finest feed grade Cottonseed Meal, which has little or no pesticide residue and contains no animal by-products. Somewhat acidic in nature, Cottonseed Meal is excellent for plants that need a low soil pH and is perfect for flowering shrubs, berries and trees when used as a slow release fertilizer.



- 5lb**
DTE07859
UPC 714360078592
Min Buy 6 EA
- 50lb (40/PL)**
DTE01948
UPC 714360019489
Min Buy 1 EA



Down To Earth™ Crab Meal 4-3-0

Crab Meal is a superb source of organic nutrients for vegetable gardens and flower beds and is wonderful for building soil tilth. Crab Meal enhances beneficial soil microorganism populations due to its rich chitin content and also makes and incredible compost bio-activator. OMRI Listed



- 5lb**
DTE07844
UPC 714360078448
Min Buy 6 EA
- 40lb (50/PL)**
DTE03940
UPC 714360039555
Min Buy 1 EA

Down To Earth™ Blood Meal 12-0-0

A source of high Nitrogen, our Blood Meal promotes rapid, green growth. A wonderful fertilizer for heavy feeders like corn, spinach, salad greens and garlic in the early spring. It also helps compost piles heat up and break down fast.



- | | |
|---|--|
| .5lb
DTE17807
UPC 714360178070
Min Buy 12 EA | 20lb (50/PL)
DTE02756
UPC 714360027569
Min Buy 1 EA |
| 5lb
DTE07807
UPC 714360078073
Min Buy 6 EA | 50lb (40/PL)
DTE01959
UPC 714360019595
Min Buy 1 EA |

Down To Earth™ Feather Meal 12-0-0

A great source of slow release organic nitrogen that is perfect for heavy feeders like corn, cole crops and leafy green vegetables. Incorporate into your soil before spring plantings for best results.



- | | |
|--|--|
| 5lb
DTE07810
UPC 714360078103
Min Buy 6 EA | 50lb (40/PL)
DTE55681
UPC 714360556816
Min Buy 1 EA |
| 20lb (50/PL)
DTE25681
UPC 714360256815
Min Buy 1 EA | |



Down To Earth™ Bone Meal 3-15-0

A wonderful source of organic phosphorus and calcium for all flowering plants, trees and ornamentals, Bone Meal is also recognized as the ideal organic fertilizer when planting bulbs to promote strong root development and enhance early season growth. Bone Meal is one of the indispensable soil amendments all organic gardeners should have on hand.



- | | |
|--|--|
| 5lb
DTE07858
UPC 714360078585
Min Buy 6 EA | 50lb (40/PL)
DTE01961
UPC 714360019618
Min Buy 1 EA |
| 25lb (40/PL)
DTE02401
UPC 714360024018
Min Buy 1 EA | |



Down To Earth™ Fish Bone Meal 4-12-0

Fish Bone Meal is a marine based alternative to traditional steamed Bone Meal and is wonderful for all flowering plants, trees and shrubs. A great source of Phosphorus and Calcium, Fish Bone Meal also contains a small amount of Nitrogen and is an ideal fertilizer for new garden beds, perennials and bulbs.



- | | |
|--|--|
| 1lb
DTE17872
UPC 714360178728
Min Buy 12 EA | 25lb
DTE04125
UPC 714360041251
Min Buy 1 EA |
| 5lb
DTE07872
UPC 714360078721
Min Buy 6 EA | 50lb (40/PL)
DTE04150
UPC 714360041503
Min Buy 1 EA |





Dry

Down To Earth™ Fish Meal 8-6-0

Fish Meal is an excellent source of Nitrogen and Phosphorus and is recommended for vegetable gardens, flower beds and all types of outdoor plants, trees and shrubs. Fish Meal enhances microbial life, promotes vigorous root development and provides an early season boost for all of your plants.



5lb

DTE07889

UPC 714360078899

Min Buy 6 EA

50lb (40/PL)

DTE08655

UPC 714360086559

Min Buy 1 EA

Down To Earth™ Granular Humic Acids

A highly concentrated source of humic acids ideal for use on fields, turf and vegetable gardens. Derived from the ancient remains of decomposed organic plant materials, humic acids enhance nutrient uptake and stimulate soil microbial life. Naturally occurring, unaltered oxidized lignite containing 70% total humic and fulvic acids, crushed, screened and graded to a particle size of 1-3 mm.



1lb

DTE17827

UPC 714360178278

Min Buy 12 EA

5lb

DTE07827

UPC 714360078271

Min Buy 6 EA

25lb (40/PL)

DTE02815

UPC 714360028153

Min Buy 1 EA

50lb (40/PL)

DTE02850

UPC 714360028504

Min Buy 1 EA

Down To Earth™ Greensand

Greensand has been used as a soil amendment and conditioner since the early 1700s. Naturally occurring in marine sedimentary deposits, our Greensand is derived from the mineral glauconite, a rich source of potash and iron. Greensand also has unique physical properties that are claimed to help loosen compacted clay soils and improve the moisture holding capacity of sandy loams.



5lb

DTE07882

UPC 714360078820

Min Buy 6 EA

50lb (40/PL)

DTE01951

UPC 714360019519

Min Buy 1 EA

25lb (40/PL)

DTE01950

UPC 714360019502

Min Buy 1 EA

Down To Earth™ Insect Frass

An excellent fertilizer with many of the same traits as bat guano and worm castings. Produced through sustainable insect farming raised on pre-consumer food waste collected from local grocery stores, produce distributors and food processors.



2lb

DTE07864

UPC 714360078646

Min Buy 6 EA

Down To Earth™ Kelp Meal 1-0.1-2

A pure Ascophyllum nodosum seaweed from the clean, cold waters of the North Atlantic Ocean. Hand-harvested, carefully dried and finely milled, our Kelp Meal provides a rich natural source of Potash and is an ideal nutrient supplement for all types of vegetables, herbs, flowers and perennials.



5lb

DTE17813

UPC 714360178131

Min Buy 12 EA

5lb

DTE07813

UPC 714360078134

Min Buy 6 EA

20lb (50/PL)

DTE01966

UPC 714360019663

Min Buy 1 EA

50lb (40/PL)

DTE01963

UPC 714360019632

Min Buy 1 EA

Down To Earth™ Langbeinite 0-0-22

A naturally mined crystalline mineral that supplies the water-soluble sulfate form of three vital plant nutrients: potassium, magnesium and sulfurs. It's maximum chlorine content is less than 3.0 percent, minimizing the potential for fertilizer burn, and it's neutral pH does not alter soil activity. Potassium contributes strongly to overall plant health by regulating internal processes. Since potassium makes up part of the fluid of the plant, it is found throughout plant tissue, meaning plants need a strong source of potassium as they grow. OMRI Listed



5lb

DTE07852

UPC 714360078523

Min Buy 6 EA

50lb (40/PL)

DTE02522

UPC 714360025220

Min Buy 1 EA

Down To Earth™ Neem Seed Meal 6-1-2

Neem Seed Meal is produced during the extraction of oil from the seed of the Indian Neem tree (*Azadiracta indica*). It is an excellent way to strengthen root systems, improve plant immunity and balance nutrient levels in the soil. Neem Seed Meal can be mixed in to soil or potting mediums, used as a top dress or steeped to make a potent foliar tea. OMRI Listed.



5lb

DTE07825

UPC 714360078257

Min Buy 6 EA

40lb (50/PL)

DTE01311

UPC 714360013111

Min Buy 1 EA



Dry

Down To Earth™ Oyster Shell

Oyster Shell flour is an all natural source of high quality calcium that is ground into varying particle sizes to ensure an immediate and sustained release of this valuable nutrient. Calcium promotes strong root development, improves nutrient uptake and boosts plant immunity.



1lb
DTE17814
UPC 714360178148
Min Buy 12 EA

25lb (40/PL)
DTE04571
UPC 714360045716
Min Buy 1 EA



5lb
DTE07884
UPC 714360078844
Min Buy 6 EA

50lb (40/PL)
DTE04572
UPC 714360045723
Min Buy 1 EA

Down To Earth™ Rock Phosphate 0-3-0

Soft rock phosphate, or colloidal phosphate, is a natural, untreated source of long-lasting phosphate and soil-building calcium. Phosphate will remain available across a wide pH range. For best availability, soft rock phosphate should be mixed into soil or compost prior to planting.



5lb
DTE07815
UPC 714360078158
Min Buy 6 EA



Down To Earth™ Seabird Guano 0-11-0

Use our high Phosphorus Seabird Guano to dramatically increase both the amount and size of blooms throughout the flowering period for all indoor and outdoor plants. Can be mixed into soils pre-plant, applied as a side dress or steeped to make a highly effective guano tea or foliar spray.



5lb
DTE07816
UPC 714360078615
Min Buy 6 EA

40lb (50/PL)
DTE02725
UPC 714360027521
Min Buy 1 EA



20lb (50/PL)
DTE02539
UPC 714360025930
Min Buy 1 EA

Dry

Down To Earth™ Shrimp Meal 6-6-0

Down To Earth™ Shrimp Meal 6-6-0 is an excellent all-purpose fertilizer rich in nitrogen, phosphorus and calcium. It is wonderful for use on all types of garden vegetables, flowers and herbs.



2lb
DTE07838
UPC 714360078387
Min Buy 6 EA



15lb (50/PL)
DTE01933
UPC 714360019335
Min Buy 1 EA



Other

Down To Earth™ Garden Gypsum

Down To Earth™ Garden Gypsum improves the physical condition of landscape, lawn and garden soils while adding calcium and sulfur. Commonly used to reduce soil compaction and increase drainage in heavy clay soils, gypsum is also used to help remediate and revitalize alkaline, sodic or saline soils.



5lb
DTE07890
UPC 714360078905
Min Buy 6 EA



Down To Earth™ Dolomite Lime

High quality, fast acting dolomite lime will sweeten soil (raise the pH) to improve plant growth and maximize fertilizer performance. Ground into ultra-fine powder then prilled into uniform granules for easy spreading. Allows for rapid reaction time once applied to soils and lawns. Supplies calcium and magnesium.



5lb
DTE07880
UPC 714360078806
Min Buy 6 EA



Down To Earth™ Garden Lime

Down To Earth™ Garden lime sweetens your soil (raises the pH) to improve plant growth and maximize fertilizer performance. Natural limestone is ground into an ultra-fine powder and then formed into uniform mini granules (prills) for easy spreading and rapid reaction time. Lime supplies calcium, an essential nutrient required for proper plant growth.



5lb
DTE07870
UPC 714360078707
Min Buy 6 EA





Other

Down To Earth™ Calcium 96

Ultra fine and highly reactive, Calcium 96 is a natural limestone powder that provides immediate availability of this valuable nutrient for plants and microflora. With a high neutralizing value, this solution grade powder can be applied at rates lower than typical Ag lime for fast soil pH changes. High quality calcium provides a myriad of benefits to plants, soils and soil biology.



1lb
DTE19096
UPC 714360190966
Min Buy 6 EA

5lb
DTE15996
UPC 714360159963
Min Buy 5 EA

Down To Earth™ Gypsum

Gypsum is composed of calcium (Ca) and sulfur (S) – two of the essential nutrients that plants require to achieve optimum growth and reach their maximum potential. Gypsum offers many advantages for soil management practices in addition to being a valuable resource for plant fertility programs. We offer a high performance solution grade powder that growers can apply with confidence.



1lb
DTE19021
UPC 714360190218
Min Buy 6 EA

5lb
DTE15921
UPC 714360159215
Min Buy 5 EA

Down To Earth™ Langbeinite 0-0-22

Potassium (K), magnesium (Mg) and sulfur (S) are three of the essential nutrients that plants require to achieve optimum growth and reach their maximum potential. This balanced and highly available water-soluble 200 mesh sulfate powder can be used in reservoirs, fertigation, drip irrigation or spray applications.



1lb
DTE19022
UPC 714360190225
Min Buy 6 EA

5lb
DTE15922
UPC 714360159222
Min Buy 5 EA

Down To Earth™ Potassium Sulfate 0-0-50

Potassium Sulfate contains potassium (K) and sulfur (S) – two of the essential nutrients that plants require to achieve optimum growth and reach their maximum potential. Nearly every major plant physiological function depends on one or both of these nutrients and here, in the highly available water-soluble sulfate form, we offer a high performance solution grade powder that growers can apply with confidence.



1lb
DTE19050
UPC 714360190508
Min Buy 6 EA

5lb
DTE15950
UPC 714360159505
Min Buy 5 EA

Water Soluble

Down To Earth™ Agmino Powder™ 14-0-0

Down To Earth™ Soluble Powder Agmino™ is a professional-grade, water-soluble nitrogen fertilizer derived from vegetable protein for supplementing plant nutrient requirements or correcting nitrogen deficiencies in all types of plants including vegetables, flowers, trees, shrubs, vines and turf grass.



1lb
DTE14401
UPC 714360144013
Min Buy 6 EA

25lb (40/PL)
DTE14425
UPC 714360144259
Min Buy 1 EA



5lb
DTE14405
UPC 714360144051
Min Buy 5 EA

Down To Earth™ Fish Powder 12-1-1

Premium quality, solution grade, high nitrogen fertilizer for promotion of rapid plant growth or correction of nitrogen deficiencies in all types of plants including vegetables, flowers, trees, shrubs, vines and turf grass. Enzymatically hydrolyzed and spray dried fish protein concentrate provides a valuable and plant available source of organic nitrogen, amino acids and minerals. More concentrated and economical than liquid fish fertilizers, Down To Earth Fish Powder 12-1-1 can be applied as a soil drench, foliar application, or filtered and run through most drip irrigation, fertigation, and sprinkler systems. Combine with seaweed powder, biological inoculants or other soluble nutrients as part of a comprehensive fertilization program.



1lb
DTE12110
UPC 714360121106
Min Buy 6 EA

44lb
DTE12144
UPC 714360121441
Min Buy 1 EA



5lb
DTE12115
UPC 714360121151
Min Buy 5 EA

Down To Earth™ Fish Bone Powder 4-20-0

Down To Earth's Fish Bone Powder 4-20-0 is a high quality, free flowing phosphate fertilizer for supplementing plant nutrient requirements or correcting deficiencies in all types of plants including vegetables, flowers, herbs, trees, shrubs and vines. It is derived from fish bone using an advanced enzymatic hydrolysis process and ground to a fine powder for easy and uniform application. Phosphate is an essential nutrient for growing plants and an adequate seasonal supply encourages plenty of buds, flowers, fruits and vegetables.



1lb
DTE12241
UPC 714360122417
Min Buy 6 EA

44lb
DTE22444
UPC 714360224449
Min Buy 1 EA



5lb
DTE12245
UPC 714360122455
Min Buy 5 EA



Other

Down To Earth™ Granular Root Growth Enhancer

Down To Earth™ Root Growth Enhancer is an all-purpose combination of Endomycorrhizal and Ectomycorrhizal Fungi to benefit a diverse selection of plants, trees and shrubs. These microscopic soil organisms are critical for developing expansive root systems, improving nutrient cycling and soil structure and protecting against a variety of plant stresses including drought and environmental extremes.



2oz
DTE36302
 UPC 714360363025
 Min Buy 24 EA



5lb
DTE36305
 UPC 714360363056
 Min Buy 5 EA



8oz
DTE36308
 UPC 714360363087
 Min Buy 12 EA

20lb
DTE36320
 UPC 714360363209
 Min Buy 1 EA



Biological Products

Down To Earth™ Soluble Root Growth Enhancer

Down To Earth™ Root Growth Enhancer is a super fine all-purpose combination of Endomycorrhizal and Ectomycorrhizal Fungi plus humic acids to benefit a diverse selection of plants, trees and shrubs. These microscopic soil organisms are critical for developing expansive root systems, improving nutrient cycling and soil structure and protecting against a variety of plant stresses including drought and environmental extremes. This easy to use, water-soluble formula will aid in dramatically increasing root growth for more vigorous plants and trees. DTE™ Soluble Root Growth Enhancer can be watered in to porous media in gardens, seed beds or propagation trays or applied directly to seeds, roots and cuttings when transplanting.



4oz
DTE36204
 UPC 714360362042
 Min Buy 12 EA



5lb
DTE36280
 UPC 714360362806
 Min Buy 5 EA



1lb
DTE36216
 UPC 714360362165
 Min Buy 6 EA

20lb
DTE36282
 UPC 714360362820
 Min Buy 1 EA

Down To Earth™ Soluble Root Zone

Down To Earth™ Soluble Root Zone is a powerful blend of beneficial soil organisms that colonize plant roots and expand into the surrounding soil to greatly increase the absorptive surface area of root systems. Our new professional grade and ultra-concentrated formula of mycorrhizal fungi, Trichoderma and a diverse mix of bacterial species work symbiotically to promote enhanced activity in the rhizosphere, improved soil structure and extensive root growth.



4oz
DTE36604
 UPC 714360366040
 Min Buy 12 EA



5lb
DTE36650
 UPC 714360366507
 Min Buy 5 EA



1lb
DTE36616
 UPC 714360366163
 Min Buy 6 EA

20lb (60/PL)
DTE36620
 UPC 714360366200
 Min Buy 1 EA

Down To Earth™ Granular Root Zone

Down To Earth™ Granular Root Zone is a powerful blend of beneficial soil organisms that colonize plant roots and expand into the surrounding soil to greatly increase the absorptive surface area of root systems. Our new professional grade and ultra-concentrated formula of mycorrhizal fungi, Trichoderma and a diverse mix of bacterial species work symbiotically to promote enhanced activity in the rhizosphere, improved soil structure and extensive root growth.



2oz
DTE36102
 UPC 714360361021
 Min Buy 24 EA



5lb
DTE36150
 UPC 714360361502
 Min Buy 5 EA



8oz
DTE36108
 UPC 714360361083
 Min Buy 12 EA

20lb (60/PL)
DTE36120
 UPC 714360361205
 Min Buy 1 EA

Liquid

Down To Earth™ Liquid All Purpose 4-1-3

Down To Earth™ Liquid All Purpose 4-1-3 is designed to promote increased shoot, flower, fruit and root development in all types of plants including flowers, fruits, herbs, ornamentals and vegetables. Use DTE™ Liquid All Purpose 4-1-3 throughout the growing season to support the natural progression of plant development for vigorous growth, abundant fruits and a bountiful harvest.



1qt
DTE13413
 UPC 714360134137
 Min Buy 10 EA

2.5gal
DTE33413
 UPC 714360334131
 Min Buy 2 EA



1gal
DTE23413
 UPC 714360234134
 Min Buy 4 EA



Liquid

Down To Earth™ Liquid Bloom™ 2-6-4

Down To Earth™ Liquid Bloom™ is designed to promote enhanced bud, flower, fruit and root development in all types of plants including flowers, fruits, herbs, ornamentals and vegetables. Use Liquid Bloom™ throughout the growing season to support the natural progression of plant development for prolific flowers, flavorful fruits and a wonderful harvest.



1qt
DTE13264
 UPC 714360132645
 Min Buy 10 EA

2.5gal
DTE33264
 UPC 714360332649
 Min Buy 2 EA



1gal
DTE23264
 UPC 714360232642
 Min Buy 4 EA

Down To Earth™ Liquid Bone Meal 0-12-0

Down To Earth™ Liquid Bone Meal 0-12-0 is a readily available source of phosphorus and calcium designed to promote increased flower, fruit, seed and vegetable production. As one of the three big nutrients for plants, phosphorus plays a role in both root and bloom development, which helps produce high-quality fruit and flowers.



1gal
DTE23012
 UPC 714360230129
 Min Buy 4 EA

2.5gal
DTE33012
 UPC 714360330126
 Min Buy 2 EA



Down To Earth™ Liquid Calcium 5%

Down To Earth™ Calcium is an essential nutrient that plays many important roles in plant growth. DTE™ Calcium is needed for cell wall formation, normal cell division in new growth and proper fruit development. Calcium deficiency can result in poor root development, yellowing of new plant tissue and fruit and vegetable abnormalities, such as blossom end rot in tomatoes. Foliar additions of calcium can be used to correct or prevent deficiencies of this valuable nutrient.



1qt
DTE13050
 UPC 714360130504
 Min Buy 10 EA

2.5gal
DTE33050
 UPC 714360330508
 Min Buy 2 EA



1gal
DTE23050
 UPC 714360230501
 Min Buy 4 EA

Down To Earth™ Liquid Fish & Kelp 2-4-1

An all-purpose natural-based liquid fertilizer made from pure hydrolyzed fish protein and a concentrated extract of cold water Ascophyllum nodosum seaweed. It is ideal for enhancing plant development and promoting longer growing periods for all garden vegetables, herbs, fruits, vines and ornamentals. Liquid Fish & Kelp provides three plant macronutrients and stimulates soil biological activity.



1qt
DTE13241
 UPC 714360132416
 Min Buy 12 EA

2.5gal
DTE33241
 UPC 714360332410
 Min Buy 2 EA



1gal
DTE23241
 UPC 714360232413
 Min Buy 4 EA



Water Soluble

Monterey® Epsom Salts (Magnesium Sulfate)

Promotes bloom in roses and other flowering plants. Absorbed through the roots and foliage of plant to help plant produce chlorophyll. OMRI listed for organic gardening.



4lb
MLGNLG7220
 UPC 022179100848
 Min Buy 6 EA



Liquid

Gold Leaf Single-Step Liquid Fertilizer

Gold Leaf is a true, single-step liquid fertilizer that delivers essential plant nutrients to hydroponic and soil grown plants. Gold Leaf reduces the number of products that need to be applied, saving growers time, money, and water.



Concentrate - 500ml
GLD81473P5
 Min Buy 1 EA

Concentrate - 1L
GLD8173
 Min Buy 1 EA





Liquid

Cutting Edge Solutions® Bloom 0-6-5™

Bloom 0-6-5™ is one of three components that create the complete Cutting Edge Solutions® 3-Part Base family. Bloom is used for the majority in the flowering stage of life, as well as small amounts in the vegetative stage.



32oz
CESCES2302
UPC 817867010024
Min Buy 1 EA

1gal
CESCES2303
UPC 817867010116
Min Buy 4 EA

2.5gal
CESCES2304
UPC 817867010222
Min Buy 1 EA

6gal
CESCES2305
UPC 817867010338
Min Buy 1 EA

15gal
CESCES3330
UPC 817867011243
Min Buy 1 EA

55gal
CESCES2307
UPC 817867010543
Min Buy 1 EA

270gal
CESCES3344
UPC 817867011335
Min Buy 1 EA



Cutting Edge Solutions® Micro 6-0-0™

Micro 6-0-0™ is one of three components that create the complete Cutting Edge Solutions® 3-Part Base family. Micro 6-0-0™ is the foundation for the 3-Part formula and is used at the same rate through the entire life cycle of your plants. Micro 6-0-0™ contains all of the micronutrients needed for peak health, along with the nitrogen and calcium foundation for the 3-Part Base formula.



32oz
CESCES2401
UPC 817867010000
Min Buy 1 EA

1gal
CESCES2403
UPC 817867010093
Min Buy 4 EA

2.5gal
CESCES2404
UPC 817867010208
Min Buy 1 EA

6gal
CESCES2405
UPC 817867010314
Min Buy 1 EA

15gal
CESCES3329
UPC 817867011151
Min Buy 1 EA

55gal
CESCES2407
UPC 817867010529
Min Buy 1 EA

270gal
CESCES3345
UPC 817867011328
Min Buy 1 EA



Cutting Edge Solutions® Bulletproof Si®

Bulletproof Si® delivers silicon in a form that may be utilized in virtually any fertilizer regimen. The silicon form (SiO₂) has shown to increase agricultural production, yield, strengthening plants, promote resistance to stressors like heat, cold, drought, lodging, accelerate maturity, promotion of a advantageous upright stature which leads to favorable exposure of leaves to light. Bulletproof Si® is formulated without potassium to facilitate application flexibility.



32oz
CESCES3315
UPC 817867010758
Min Buy 1 EA

1gal
CESCES3316
UPC 817867010765
Min Buy 4 EA

2.5gal
CESCES3340
UPC 817867010772
Min Buy 1 EA

6gal
CESCES3341
UPC 817867010789
Min Buy 1 EA

15gal
CESCES3342
UPC 817867011236
Min Buy 1 EA

55gal
CESCES3408
UPC 817867011526
Min Buy 1 EA

270gal
CESCES3410
UPC 817867011564
Min Buy 1 EA



Cutting Edge Solutions® Grow 2-1-6™

Grow 2-1-6™ is one of three components that create the complete Cutting Edge Solutions® 3-Part Base family. Use Grow 2-1-6™ in the vegetative and transitional stages of plant life. During full flower stage, the use of Grow 2-1-6™ is discontinued.



32oz
CESCES2202
UPC 817867010017
Min Buy 1 EA

1gal
CESCES2203
UPC 817867010109
Min Buy 4 EA

2.5gal
CESCES2204
UPC 817867010215
Min Buy 1 EA

6gal
CESCES2205
UPC 817867010321
Min Buy 1 EA

15gal
CESCES3331
UPC 817867011137
Min Buy 1 EA

55gal
CESCES2207
UPC 817867010536
Min Buy 1 EA

270gal
CESCES3343
UPC 817867011342
Min Buy 1 EA





Liquid

Cutting Edge Solutions® Plant Amp™

Plant Amp™ supplies calcium in a soluble formula that optimizes passive uptake by the plant. Calcium is essential in metabolic processing of nutrients and functioning of enzymes and hormones. Calcium strengthens cell walls to improve resistance to heat stress and diseases. Plant Amp™ is formulated for use in hydroponics, soilless, continuous feed, drain to waste, and for use in soil. Plant Amp™ can be applied at every watering in conjunction with any of Cutting Edge Solutions® products, or other commercially available hydroponic nutrients.



- | | |
|--|--|
| 32oz
CESCES2502
UPC 817867010031
Min Buy 1 EA | 15gal
CESCES3333
UPC 817867011168
Min Buy 1 EA |
| 1gal
CESCES2503
UPC 817867010123
Min Buy 4 EA | 55gal
CESCES2507
UPC 817867010550
Min Buy 1 EA |
| 2.5gal
CESCES2504
UPC 817867010239
Min Buy 1 EA | 270gal
CESCES2508
UPC 817867011618
Min Buy 1 EA |
| 6gal
CESCES2505
UPC 817867010345
Min Buy 1 EA | |



Cutting Edge Solutions® SourDee 0-0-2™

Sour-Dee™ supplies potassium and a carbohydrate source in a unique and proprietary formulation. Potassium promotes flower bulk and quality by supporting carbohydrate metabolism. Use Sour-Dee™ every feeding during the flowering phase. You may increase the recommended dilution ratio, up to three times, to a maximum of 30ml during the final 3-4 weeks of flowering. Sour-Dee™ can be used in conjunction with all Cutting Edge Solutions® products, or other commercial hydroponic nutrients. Designed for use in Hydroponics, soilless, continuous feed systems, drain to waste, and soil applications.



- | | |
|--|--|
| 32oz
CESCES3301
UPC 817867010079
Min Buy 1 EA | 15gal
CESCES3336
UPC 817867011205
Min Buy 1 EA |
| 1gal
CESCES3302
UPC 817867010161
Min Buy 4 EA | 55gal
CESCES3306
UPC 817867010598
Min Buy 1 EA |
| 2.5gal
CESCES3303
UPC 817867010277
Min Buy 1 EA | 270gal
CESCES3305
UPC 817867011540
Min Buy 1 EA |
| 6gal
CESCES3304
UPC 817867010376
Min Buy 1 EA | |



Cutting Edge Solutions® Mag Amped™

Mag-Amped™ supplies magnesium in a soluble formula that optimizes passive uptake by the plant. Magnesium promotes synthesis of chlorophyll, activates transcription of proteins and enzymes needed for plant growth, promotes root development, and increases the plant's ability to tolerate low temperatures. Mag-Amped™ also provides sulfur. Sulfur is a necessary micronutrient for optimal plant growth and crop production. Mag-Amped™ is formulated for use in hydroponics, soilless, continuous feed, drain to waste, and for use in soil. At higher concentrations, Mag-Amped™ can quickly correct magnesium deficiency.



- | | |
|--|--|
| 32oz
CESCES2801
UPC 817867010055
Min Buy 1 EA | 15gal
CESCES3332
UPC 817867011144
Min Buy 1 EA |
| 1gal
CESCES2802
UPC 817867010147
Min Buy 4 EA | 55gal
CESCES2806
UPC 817867010574
Min Buy 1 EA |
| 2.5gal
CESCES2803
UPC 817867010253
Min Buy 1 EA | 270gal
CESCES2807
UPC 817867011601
Min Buy 1 EA |
| 6gal
CESCES2804
UPC 817867010369
Min Buy 1 EA | |



Cutting Edge Solutions® Cal Mag Amplified™

Cal-Mag Amplified™ is an ideal choice for supplementing native soil with pure, rapidly absorbable forms of calcium and magnesium. Coco coir growers will greatly benefit from the use of Cal-Mag Amplified™ by providing additional calcium to buffer the coco and maximize cation exchange capacity. Higher levels of magnesium are necessary for some plant varieties and heirlooms that originate from equatorial regions. The additional source of magnesium in Cal-Mag Amplified™ will drive chlorophyll production and maximize photosynthesis. Plants fortified with calcium and magnesium exhibit lush green leaves and reward the farmer with heavy fruits. Foliar application is also highly recommended as a way to provide the plants with direct sources of calcium to fortify cell walls through the apoplast pathway, freeing mobile calcium to be used for fruit set. Spray when the sun is first rising or setting for the night to ensure stomata are fully dilated.



- | | |
|--|--|
| 32oz
CESCES3501
UPC 817867011724
Min Buy 1 EA | 15gal
CESCES3509
UPC 817867011755
Min Buy 1 EA |
| 1gal
CESCES3503
UPC 817867011700
Min Buy 4 EA | 55gal
CESCES3512
UPC 817867011762
Min Buy 1 EA |
| 2.5gal
CESCES3505
UPC 817867011731
Min Buy 1 EA | 270gal
CESCES3516
UPC 817867011779
Min Buy 1 EA |
| 6gal
CESCES3507
UPC 817867011748
Min Buy 1 EA | |





Liquid

Cutting Edge Solutions® Uncle Johns Blend 0-0-2™

Uncle John's Blend™ supplies potassium along with iron in a unique and proprietary formula. Potassium activates enzymes essential for plant growth reproduction and carbohydrate metabolism. Uncle John's Blend™ is formulated for use in hydroponics, soilless, continuous feed, drain to waste, and for use in soil. Use as a foliar spray to reduce transplanting stress and to correct potassium deficiencies in flowering plants.



32oz
CESCES2602
UPC 817867010048
Min Buy 1 EA

1gal
CESCES2603
UPC 817867010130
Min Buy 4 EA

2.5gal
CESCES2604
UPC 817867010246
Min Buy 1 EA

6gal
CESCES2605
UPC 817867010352
Min Buy 1 EA

15gal
CESCES3334
UPC 817867011229
Min Buy 1 EA

55gal
CESCES2607
UPC 817867010567
Min Buy 1 EA

270gal
CESCES2610
UPC 817867011519
Min Buy 1 EA



Cutting Edge Solutions® Sugaree 0-0-2™

Sugaree™ supplies potassium and a carbohydrate source in a unique and proprietary formulation. Potassium promotes flower bulk and quality by supporting carbohydrate metabolism. Use Sugaree™ every feeding during the flowering phase. You may increase the recommended dilution ratio, up to three times, to a maximum of 30ml during the final 3-4 weeks of flowering. Sugaree™ can be used in conjunction with all Cutting Edge Solutions® products, or other commercial hydroponic nutrients. Designed for use in Hydroponics, soilless, continuous feed systems, drain to waste, and soil applications.



32oz
CESCES2901
UPC 817867010062
Min Buy 1 EA

1gal
CESCES2902
UPC 817867010154
Min Buy 4 EA

2.5gal
CESCES2903
UPC 817867010260
Min Buy 1 EA

6gal
CESCES2904
UPC 817867010383
Min Buy 1 EA

15gal
CESCES3335
UPC 817867011212
Min Buy 1 EA

55gal
CESCES2906
UPC 817867010581
Min Buy 1 EA

270gal
CESCES2910
UPC 817867011557
Min Buy 1 EA



Liquid

13Essentials Foliar Fertilizer

13Essentials is a balanced, nanoscale foliar fertilizer specially designed to increase the overall growth and health of your indoor plants. The unique formula contains Silica as well as 12 other nutrients to maximize results yielded by indoor plants grown in soil, hydroponically or in an alternate media such as coco.



2oz
ESS13E020Z
UPC 860028000280
Min Buy 12 EA

4oz
ESS13E040Z
UPC 862168000328
Min Buy 12 EA

8oz
ESS13E080Z
UPC 862168000311
Min Buy 2 EA



Water Soluble

Sequestar Iron Chelate 6% Fe EDDHA

Sequestar is a water soluble form of iron EDDHA that is readily available to plants. It can be applied to prevent or correct iron deficiency. Sequestar can be used on vegetable crops, vine and berry crops, fruit and nut trees, and ornamental shrubs, bedding plants and groundcovers.



25lb
BRANDT2955-01-025
Min Buy 1 EA





Liquid

Roots Organics Ancient Amber

A highly-soluble and distinctly active Natural nitrogen source extracted from nettle, a nutrient-rich perennial plant used by humans since ancient times, and from a non-GMO soybean meal. Derived from Soybean Fermentation Extract And Nettle Extract.



32oz

AURROAAQ

UPC 609728632328

Min Buy 1 EA

1gal

AURROAAG

UPC 609728632335

Min Buy 4 EA



Roots Organics Buddha Bloom

Promotes vigor, substantially increase yields and enhance the quality of production and flavor in soil-grown plants during their growth and bloom stages. Distinctive blends of the finest organic ingredients are harvested from natural sources around the world, providing secure livelihoods for communities engaged in the sustainable extraction and production of these high-quality nutrients. Worldwide sourcing and deliberate design create exceptional liquid blends that are targeted to encourage excellence in your plants. Derived from Bat Guano, Molasses, Worm Castings, Yucca Extract, Kelp Extract (Ascophyllum nodosum), Soy Extract.



32oz

AURROBBQ

UPC 609728632274

Min Buy 1 EA

1gal

AURROBBG

UPC 609728632281

Min Buy 4 EA



Roots Organics Buddha Grow

Promotes vigor, substantially increase yields and enhance the quality of production and flavor in soil-grown plants during their growth and bloom stages. Distinctive blends of the finest organic ingredients are harvested from natural sources around the world, providing secure livelihoods for communities engaged in the sustainable extraction and production of these high-quality nutrients. Worldwide sourcing and deliberate design create exceptional liquid blends that are targeted to encourage excellence in your plants. Derived from Bat Guano, Kelp Extract (Ascophyllum nodosum), Soy Extract, Molasses, Worm Castings, Yucca Extract.



32oz

AURROBGQ

UPC 609728632229

Min Buy 1 EA

1gal

AURROBG

UPC 609728632236

Min Buy 4 EA



Roots Organics CalMag

A pure and all natural blend of calcium, magnesium and sulfur to support plants during fast growth. By creating a product free of added nitrogen, phosphate, and potassium, we give you control to supplement as needed without affecting primary fertility input ratios. Roots Organics CalMag is ideal for fast-growing and heavy feeding plants. Use in combination with high quality base fertilizers like Roots Organics Buddha Grow and Buddha Bloom.



32oz

AURROCMQ

UPC 799493712223

Min Buy 12 EA

1gal

AURROCMG

UPC 799493712230

Min Buy 1 EA



Roots Organics Extreme Serene

A natural source of growth-promoting nutrients and botanical extracts. Targeted and isolated crucial components in various kelp species and stabilized the solution for maximum absorption. Extreme Serene captures the fast-growing power of marine kelp to encourage vigorous shoot and root growth. Use Extreme Serene in conjunction with any nutrient program or as a foliar feed.



32oz

AUROESQ

UPC 609728632373

Min Buy 1 EA

1gal

AUROESG

UPC 609728632380

Min Buy 4 EA



Roots Organics HP2

Liquid seabird guano is a natural source of phosphorus, ideal for use during flowering and fruiting. Aurora Innovations has taken generations of gardening experience and distilled it into a unique, easy-to-use formula for the hobbyist and professional gardener. Roots Organics HP2 is minimally processed to preserve all of the benefits and amazing synergistic qualities found in seabird guano and biogenic phosphate rock.



32oz

AURROHPQ

UPC 609728632472

Min Buy 1 EA

1gal

AURROHPG

UPC 609728632489

Min Buy 4 EA



Liquid

Roots Organics HPK

Liquid bloom booster features a combination of seabird guano, an unparalleled source of available natural phosphorus, phosphate rock, and langbeinite, a natural source of potassium that is carefully mined from ancient sea beds in the deserts of the American Southwest. Taken generations of gardening experience and distilled it into a distinctive, easy-to-use formula for the home and professional gardener. Roots Organics HPK is minimally processed to preserve all the benefits and amazing synergistic qualities found in our exceptional ingredients.



32oz

AURROHPKQ

UPC 609728632526

Min Buy 1 EA

2.5gal

AURROHPK25G

UPC 609728632540

Min Buy 2 EA

1gal

AURROHPKG

UPC 609728632533

Min Buy 4 EA



Roots Organics Trinity

A complex blend of organic and natural plant nutrients designed for maximum effect as a plant and rhizosphere growth enhancer. With its deliberate blend of distinct plant nutrients, Trinity is a universal supplement for growth and bloom. A distinctive formula of complex carbohydrates combined with soy protein extracts to encourage plant vigor, reduce stress, maximize root growth and increase plant yield. Trinity can be used with any nutrient program.



32oz

AURROTQ

UPC 609728632427

Min Buy 1 EA

2.5gal

AURROT25G

UPC 609728632441

Min Buy 2 EA

1gal

AURROTG

UPC 609728632434

Min Buy 4 EA



Roots Organics Rain

Promotes water penetration and aids in the dispersion of foliar applications. A combination of the natural wetting agents yucca and quillaja, this product reduces water surface tension and enhances the movement of solutions and soluble nutrients throughout the rhizosphere.



32oz

AURRORQ

UPC 799493712124

Min Buy 12 EA

1gal

AURRORG

UPC 799493712131

Min Buy 4 EA



Soul Amino Aide

A complex amino acid blend specifically formulated to increase plant vigor and yields. Chemists at Aurora Innovations created this blend of amino acids after extensive, hands-on research into compounds that can be beneficial for plant growth and yields. Harness that power with Amino-Aide and see the results for yourself. Great for both potting soil and hydroponic gardening.



32oz

AURSSAQ

UPC 609728632762

Min Buy 12 EA

1gal

AURSSAAG

UPC 609728632779

Min Buy 4 EA



Roots Organics Surge

This plant nutrient and microbe stimulant is designed from the finest sustainably-harvested and enzymatically processed marine protein materials. The addition of natural sugar, kelp and humic acid to a powerful fish base creates a potent fusion of natural compounds to enhance the distinctive qualities and flavor of your harvest. Faster growth and greater yields for lush plants rich with essential oils - all these benefits from one powerful product.



32oz

AURROSQ

UPC 609728632175

Min Buy 1 EA

1gal

AURROSRG

UPC 609728632182

Min Buy 4 EA



Soul Big Swell

Designed specifically to increase flower size, vigor and quality. Aurora's research has resulted in a distinctive formula of powerful natural botanical extracts, amino acids and molasses combined to yield a specific ratio of available phosphorus and potassium. For exceptional results, use Soul Big Swell as an additive in conjunction with any base nutrient program.



32oz

AURSSSQ

UPC 609728632816

Min Buy 1 EA

1gal

AURSSBSG

UPC 609728632823

Min Buy 4 EA





Liquid

Soul Bloom

A powerful blend of soluble and natural fertility components, enhanced with potent botanical extracts. Designed specifically for enhanced quality and increased yields in versatile, demanding applications for the bloom stage. Soul Bloom and Grow are user-friendly and pH stable.



32oz
AURSSBQ
 UPC 609728632717
 Min Buy 12 EA
1gal
AURSSBG
 UPC 609728632724
 Min Buy 4 EA



Soul Grow

A powerful blend of soluble and natural fertility components, enhanced with potent botanical extracts. Apply during the growth stage for quality and increased yields. Formulated from only the highest quality soluble and natural ingredients and targeted to increase plant vigor for larger harvests. Designed for diverse applications.



32oz
AURSSGQ
 UPC 609728632663
 Min Buy 12 EA
1gal
AURSSGG
 UPC 609728632670
 Min Buy 4 EA



Soul Infinity

A complex blend of powerful natural plant nutrients we formulated to increase vigor and prevent nutrient deficiencies common in fast-growing and heavy-feeding plants. With its deliberate blend of distinct ingredients, Soul Infinity can be used with any base fertilizer line as a powerful supplement to increase growth and yields.



32oz
AURSSIQ
 UPC 609728632960
 Min Buy 12 EA
1gal
AURSSIG
 UPC 609728632977
 Min Buy 4 EA



Soul Grow-N

Nitrogen supplement was specifically crafted for the gardener who demands faster growth from high-performance fertilizers. A deliberate blend of fast-acting and natural nitrogen and calcium sources engineered for maximum effect and high solubility. Grow-N puts the controlled application of these essential nutrients in your hands. For exceptional results, combine these highly soluble, fast-acting nutrients with any base nutrient program.



32oz
AURSSGNQ
 UPC 609728632861
 Min Buy 12 EA
1gal
AURSSGNG
 UPC 609728632878
 Min Buy 4 EA



Soul Peak

Contains distinctive botanical extracts, as well as ample phosphorus and potassium to encourage only the strongest flowers. Years of research and extensive testing have resulted in a truly unique PK formulation that enhances the vigor of plants during their blooming phase. Soul Peak supports the development of intense features and show-quality blooms in your favorite flowers.



32oz
AURSSPKQ
 UPC 609728632915
 Min Buy 12 EA
1gal
AURSSPKG
 UPC 609728632922
 Min Buy 4 EA



Water Soluble

Roots Organics Terp Tea Grow

Delivers critical nutrition for heavy-feeding, high-yield plants. Recommended for both large and small-scale gardens, this high-quality dry fertilizer is simple, comprehensive, and completely natural. Our powerful one-part grow and one-part bloom formula can serve as base nutrition or as a supplement, and can be delivered in large batches or controlled point feedings. Amend any potting soil with this micronized vegetative nutrient to activate the aromatic power of your garden's natural terpenes.



3lb

AURROTTG3

UPC 799493711292

Min Buy 3 EA

9lb

AURROTTG9

UPC 799493711936

Min Buy 3 EA



Root Organics Terp Tea Microbe Charge

Terp Tea Microbe Charge delivers beneficial bacteria, mycorrhizal fungi, and a nutrient charge to support vigorous root systems in heavy-feeding, high-yield plants. Recommended for both large and small-scale gardens, this high-quality formula is simple, effective, and allowed for use in organic crop production. This formula will function great as a direct application or, ideally, can be brewed into a potent tea.



3lb

AURROTTMC3

UPC 799493712575

Min Buy 3 EA

9lb

AURROTTMC9

UPC 799493712582

Min Buy 3 EA

20lb

AURROTTMC20

UPC 799493712599

Min Buy 1 EA

40lb

AURROTTMC40

UPC 799493712605

Min Buy 1 EA



Roots Organics Terp Tea Bloom

Delivers critical nutrition for heavy-feeding, high-yield plants. Recommended for both large and small-scale gardens, this high-quality dry fertilizer is simple, comprehensive, and completely natural. Our powerful one-part grow and one-part bloom formula can serve as base nutrition or as a supplement, and can be delivered in large batches or controlled point feedings. Amend any potting soil with this micronized flowering nutrient to activate the aromatic power of your garden's natural terpenes.



3lb

AURROTTB3

UPC 799493711875

Min Buy 3 EA

9lb

AURROTTB9

UPC 799493711882

Min Buy 3 EA

20lb

AURROTTB20

UPC 799493711899

Min Buy 1 EA

40lb

AURROTTB40

UPC 799493711905

Min Buy 1 EA



Roots Organics Bio Force

Supplies a suite of powerful bacteria and fungi to your plant's root system and surrounding rhizosphere. Our researchers have selected specific organisms and ratios to maximize benefits to your garden. This grouping is selected for their ability to increase nutrient availability and to help container grown plants resist abiotic stress. Roots Organics Bio Force proprietary biological inoculant blend contains beneficial bacteria and fungi with sustaining microbial food to enhance crop production.



4oz

AUROBF4

UPC 799493712377

Min Buy 12 EA



Roots Organics Terp Tea Bloom Booster

Terp Tea Bloom Booster adds a strategic fertility input for your garden. This proprietary ratio of potent ingredients supplements flowering plants in the later stages of development, enhancing blossom vigor. The result of extensive research and development, Roots Organics Terp Tea Bloom Booster helps bring the ratio of potassium and other primary macronutrients into your targeted range to provide Soluble Potash supplementation that boosts harvest quality and yields.



3lb

AURROTTBB3

UPC 799493712520

Min Buy 3 EA

9lb

AURROTTBB9

UPC 799493712537

Min Buy 3 EA

20lb

AURROTTBB20

UPC 799493712544

Min Buy 1 EA

40lb

AURROTTBB40

UPC 799493712551

Min Buy 1 EA



Roots Organics Elemental

A calcium and magnesium supplement was specifically created to augment calcium and magnesium levels and prevent deficiencies that can occur with fast-growing plants. Elemental contains two absolutely essential macronutrients: Calcium, an essential nutrient for plant health due to its role in cell walls, membranes and other biochemical processes; and magnesium, which is a central component of the chlorophyll molecule. Supplementing calcium and magnesium is one of the secrets of expert growers and results in more vigorous plants and larger yields.



3lb

AUROEL3

UPC 609728632571

Min Buy 3 EA

9lb

AUROEL9

UPC 609728632588

Min Buy 3 EA





Dry

Roots Organics Dry Player Pack

The Dry Players Pack by Roots Organics is a complete, dry nutrient system for both beginners and master growers. The Dry Player Pack includes everything you need to promote heavier yields of higher quality plants. The Dry Player Pack is designed to be used with organic soil to complement the organic dry nutrient pack.



7pcs

AURRODNPLAY

UPC 609728632052

Min Buy 1 EA



Roots Organics Essential Earth

A concentrated natural humic acid supplement derived from natural Leonardite from a freshwater peat source. This premium humic acid soil conditioner is designed to aid in the uptake of micronutrients.



3lb - Granular

AURROEEG3

UPC 799493711974

Min Buy 3 EA

3lb - Powder

AURROEE3

UPC 609728632618

Min Buy 3 EA



Roots Organics Fish Protein

A truly powerful source of key plant nutrients. Potent levels of water soluble Nitrogen and other available and soluble primary nutrients hydrolyzed for easy delivery to your plants as a liquid suspension, a powerful top-dress, or a dynamic amendment. Roots Organics Fish Protein is a rapidly available plant nutrient supplement that allows the discerning grower to target specific nutritional needs and maximize vigor, growth and yield.



3lb

AURROFP3

UPC 799493712025

Min Buy 3 EA



Roots Organics NitroBat Guano

An excellent source of nitrogen, phosphate and calcium. Carefully processed and sifted to make it easy to work with, Roots Organics Nitro Bat Guano encourages vigorous growth and is fast acting for quick results.



3lb

AURRONB3

UPC 609728631444

Min Buy 3 EA



Roots Organics Non-GMO Soybean Meal

A powerful source of slow-release nitrogen. When used as an amendment or top dress, Non-GMO Soybean Meal is particularly effective for encouraging vigorous vegetative growth. Ethically sourced for quality. Roots Organics—performance with principles.



3lbs

AURROSBM3

UPC 799493711431

Min Buy 3 EA



Roots Organics Phos Rock

Roots Organics Phos Rock is an excellent source of phosphorus and calcium. Carefully processed and sifted to make it easy to work with, Roots Organics Phos Rock encourages vigorous flowering and fruiting. All of the Roots Organics guanos have been sourced for quality and harvested with bat-friendly methods so you and your garden get performance with principles.



3lbs

AURROPR3

UPC 799493712179

Min Buy 3 EA



Roots Organics Oregonism XL

This root growth enhancer helps to increase nutrient availability and uptake, encourages vigorous root systems, and helps container grown plants to resist stress. Oregonism XL increases root mass and size by colonizing the root system with symbiotic fungi and bacteria. The fungi extend their network into the surrounding plant rhizosphere, massively increasing plants' ability to uptake water and vital nutrients. Increased root surface area and enhanced nutrient uptake help to boost plant productivity and yield.



2oz

AURROIXP

UPC 609728631369

Min Buy 24 EA

4oz

AURROIX4

UPC 609728631376

Min Buy 12 EA

1lb

AURROIX1

UPC 609728631390

Min Buy 12 EA

3lb

AURROIX3

UPC 609728631406

Min Buy 3 EA



Roots Organics SeaBird Guano

An excellent source of phosphate and calcium. Carefully sifted and processed to make it easy to work with, Roots Organics Seabird Guano encourages vigorous growth and is fast-acting for quick results.



3lb - Granular

AURROPSBG3

UPC 609728631796

Min Buy 3 EA

3lb - Powder

AURROPSBP3

UPC 799493711820

Min Buy 3 EA



Dry

Roots Organics SuperPhos Rock

Roots Organics Super Phos Rock is incredibly high in phosphorus and calcium and is extracted from select caves when the quality is at its highest. Potent and powerful high phosphorus guano consciously extracted to not disturb the bat colonies, and to provide an unparalleled completely natural source of phosphorus and calcium. Roots Organics Super Phos Rock is fast acting and so powerful it should be used carefully and sparingly.



3lb

AURROSPR3

UPC 799493711479

Min Buy 3 EA



Roots Organics Uprising Foundation

A diverse blend of 100% natural and organic ingredients formulated for maximum results. When used alone as an amendment or as a top dress, this formula is effective for supplementing calcium, magnesium and iron. It is particularly dynamic when blended with Roots Organics Uprising Grow (for the vegetative growth phase) and with Roots Organics Uprising Bloom (for the bloom phase).



3lb

AURROUF3

UPC 609728631598

Min Buy 3 EA



Roots Organics Uprising Grow

A diverse blend of 100% natural and organic ingredients specially formulated for maximum results. This formula is effective alone as an amendment or as a top dress for encouraging vigorous growth. Use it in conjunction with Roots Organics Uprising Bloom during a plant's flowering phase or combine it with Roots Organics Uprising Foundation to create a powerful supplement.



3lb

AURROUG3

UPC 609728631642

Min Buy 3 EA



Roots Organics Uprising Bloom

A diverse blend 100% natural and organic ingredients formulated for maximum results. This formula is effective alone as an amendment or as a top dress for encouraging vigorous flowering and fruiting. Uprising Bloom is most effective when used in conjunction with Roots Organics Uprising Grow during a plant's vegetative phase, or with Roots Organics Uprising Foundation as a supplement.



3lb

AURROUB3

UPC 609728631697

Min Buy 3 EA



Soul Soilless Growing Mix

Soul LBS. flower booster delivers targeted soluble nutrition to supercharge your blooms. A proprietary blend of key micronutrients combined with easy dissolving phosphorus and potassium to increase flowering and yield. A powerful ally for your root zone, Soul LBS. embodies our unique approach: supplementing biology with versatile organisms and supporting their growth with a sucrose sugar booster. In soil or soilless applications, Soul LBS. should be used with a balanced primary fertilizer program such as our Soul nutrients.



3lb

AURSSLBS3

UPC 609728633042

Min Buy 3 EA





BIG FOOT MYCORRHIZAE



Water Soluble

Big Foot™ Mycorrhizae Gold

Big Foot™ Gold exists so the most demanding growers can turn their biggest ideas into their greatest work. Big Foot™ Gold contains a list of proprietary ingredients that are designed to limit transplant shock, accelerate mycorrhizal colonization, build the soil food web, greatly increase nutrient and water uptake, and give your plant explosive root growth.



4oz
ARCBFAU04

UPC 733447666224
Min Buy 6 EA

5lb
ARCBFAU5

UPC 733447666255
Min Buy 1 EA

8oz
ARCBFAU08

UPC 733447666248
Min Buy 6 EA

32oz
ARCBFAU32

UPC 733447666200
Min Buy 1 EA



Dry

Big Foot™ Mycorrhizae Concentrate

Big Foot™ Concentrate is a water-in product. Concentrate helps the plant form a root surface area up to 1000x the normal size. This leads to increased plant health, vigor, survivability, pathogen suppression, and yield. Contains endomycorrhizae, biochar, worm castings, kelp, humic acid. Apply to new and existing plants.



4oz
ARCBFC04

UPC 648620953629
Min Buy 5 EA

10lb
ARCBFC10

UPC 648620953681
Min Buy 1 EA

8oz
ARCBFC08

UPC 648620953636
Min Buy 6 EA

50lb
ARCBFC50

UPC 648620953704
Min Buy 1 EA



32oz
ARCBFC32

UPC 648620953643
Min Buy 2 EA

Big Foot™ Mycorrhizae Granular

Big Foot™ Granular is perfect for transplanting. Granular helps the plant form a microbial web which increases the root surface area up to 1000x. Designed to maximize vigor, health, and yield. This product will minimize transplant shock and increase survivability. Contains endomycorrhizae, biochar, worm castings, kelp, humic acid. Mix-in soil. Apply to new plants.



4oz
ARCBFG04

UPC 648620953650
Min Buy 5 EA

10lb
ARCBFG10

UPC 648620953674
Min Buy 1 EA

2lb
ARCBFG2

UPC 648620953667
Min Buy 6 EA

50lb
ARCBFG50

UPC 648620953698
Min Buy 1 EA



Water Soluble

BASF® Sprint® 138 6% EDDHA Iron Chelate

A 6% EDDHA chelated iron micronutrient that can be applied as a soil application or as a foliar spray to correct iron deficiencies. Provides an iron source that is readily available to plants, even at higher than ideal soil pH. Sprint 138 will make iron plant-available at a higher soil pH than Sprint 330.



5lb
BAS59013436

Min Buy 1 BG



BASF® Sprint® 330 10% DTPA Iron Chelate

A 10% DTPA chelated iron micronutrient that can be applied as a soil application or as a foliar spray to correct iron deficiencies. Provides an iron source that is readily available to plants, even at higher than ideal soil pH.



50lb
BAS59013097

Min Buy 1 DR



DRAMM

Liquid

Dramm® Nutrifog™

NutriFOG for PulsFOG™ thermal foggers is a 10-3-3 foliar fertilizer and carrier solution to improve fogging performance. When used correctly, NutriFOG will improve the fog quality and coverage distance by reducing the surface tension of the water in the Puls-FOG spray tank. It can be used with all chemical formulations.



20Lt
DRMNF20

Min Buy 1 EA





Dry

BioAG Cytoplus™

All the benefits of kelp and micronutrients enhanced by concentrated humic/fulvic powder. Best use: especially beneficial during key transitional periods. Such as growing from vegetative to bloom.



- 100g**
BAGBA76001
UPC 810051910520
Min Buy 24 EA
- 300g**
BAGBA76003
UPC 810051910490
Min Buy 12 EA
- 1kgs**
BAGBA76022
UPC 810051910230
Min Buy 4 EA
- 5lbs**
BAGBA76050
UPC 810051910346
Min Buy 4 EA
- 50lbs**
BAGBA76500
UPC 810051910421
Min Buy 1 EA



BioAG Ful-Humix®

Concentrated Humic/Fulvic Soluble Powder. 1# of Ful-Humix = 1 - 2 gallons of competitors liquid. Improves soil nutrient retention and uptake for strong, healthy plants. Best use; throughout growing cycle indoor/outdoor soils.



- 100g**
BAGBA72001
UPC 810051910506
Min Buy 24 EA
- 300g**
BAGBA72003
UPC 810051910537
Min Buy 12 EA
- 1kgs**
BAGBA72022
UPC 810051910254
Min Buy 4 EA
- 5lbs**
BAGBA72050
UPC 810051910353
Min Buy 4 EA
- 50lbs**
BAGBA72500
UPC 810051910407
Min Buy 1 EA



Dry

BioAG TM-7™

7 micronutrients critical for plant success, plus concentrated humic/fulvic powder for increased absorption and efficacy. Best use: throughout season in indoor / outdoor soil and/or with compost tea.



- 100g**
BAGBA74001
UPC 810051910513
Min Buy 24 EA
- 300g**
BAGBA74003
UPC 810051910483
Min Buy 12 EA
- 1kgs**
BAGBA74022
UPC 810051910247
Min Buy 4 EA
- 7.5lbs**
BAGBA74050
UPC 810051910339
Min Buy 4 EA
- 50lbs**
BAGBA74500
UPC 810051910414
Min Buy 1 EA



BioAG Vam Endo-Mix

7 potent endo strains blended with the right substrates to guarantee your success! Give your plants a boost, roots up!



- 100g**
BAGBA78001
UPC 810051910469
Min Buy 24 EA
- 300g**
BAGBA78003
UPC 810051910476
Min Buy 12 EA
- 1kgs**
BAGBA78022
UPC 810051910209
Min Buy 4 EA
- 5lbs**
BAGBA78050
UPC 810051910322
Min Buy 4 EA



Liquid

BioAG Ful-Power®

Purified fulvic acid made via a special enzymatic reaction. Works in all pH ranges and all systems. Clean and Powerful! Improves plant biological functions from roots to flowers to fruits. Best use: great for hydro/aeroponics, foliar and soils. Use a little all the time, from seeds, cutting throughout flush/harvest!



- 1qt**
BAGBA70004
UPC 810051910094
Min Buy 12 EA
- 1gal**
BAGBA70010
UPC 810051910063
Min Buy 4 EA
- 2.5gal**
BAGBA70025
UPC 810051910032
Min Buy 2 EA
- 5gal**
BAGBA70050
UPC 810051910001
Min Buy 1 EA
- 55gal**
BAGBA70550
UPC 810051910117
Min Buy 1 EA
- 275gal**
BAGBA70750
UPC 810051910148
Min Buy 1 EA





Liquid

CalOx® pH Micronized Calcium Carbonate

A micronized flowable lime made up of over 70% active ingredient and is specifically formulated to immediately raise soil pH. Ideal product for crops like geraniums, poinsettias and greenhouse tomatoes. Since it won't clog lines, it is easily direct injected as a drench application, stabilizing the soil pH for more than 35 days.



2.5gal
BSF201125
 Min Buy 1 BT



Water Soluble

TerraGrow® Beneficial Soil Inoculant

A beneficial soil inoculant designed to improve soil characteristics and plant stress tolerance. Quickly re-establishes beneficial bacteria/fungal populations in and around the root zone.



4lb
BSF71004
 Min Buy 1 EA

25lb
BSF710025
 Min Buy 1 EA

10lb
BSF710010
 Min Buy 1 EA



BLACKSMITH
 BIOSCIENCE



Water Soluble

Armory

Armory is a high concentration of Bacillus and Streptomyces bacteria that will increase the beneficial microbial population of soils for maximum plant vigor, growth and yield. Armory can be tank mixed with chemicals, fertilizers, and other biologicals. Apply as a drench, foliar spray, or soil incorporation. For use on fruits, vegetables, herbs and medicinal herbs, turf and ornamentals and more.



2oz
BBSLGR002
 UPC 865724000206
 Min Buy 1 EA

1lb
BBSLGR016
 UPC 865724000275
 Min Buy 1 EA

200oz
BBSLGR0200
 Min Buy 1 EA



MegaPhos SP

MegaPhos SP is a high concentration of a unique bacteria that solubilizes phosphorus making it more available to some plants. MegaPhos can be tank mixed with chemicals, fertilizers, and other biologicals. Apply as a drench, foliar spray, or soil incorporation. For use on fruits, vegetables, herbs and medicinal herbs, turf and ornamentals and more.



2oz
BBSLGMP002
 UPC 858161007006
 Min Buy 1 EA

1lb
BBSLGMP016
 UPC 858161007013
 Min Buy 1 EA

200oz
BBSLGMP0200
 UPC 858161007020
 Min Buy 1 EA



Nitryx SP

Nitryx SP is a high concentration bacteria that fixes nitrogen from the atmosphere and increases the content of plant available nitrogen in soil. Nitryx can be tank mixed with chemicals, fertilizers, and other biologicals. Apply as a drench, foliar spray, or soil incorporation. For use on fruits, vegetables, herbs and medicinal herbs, turf and ornamentals and more.



4oz
BBSLGNX0040
 UPC 865724000244
 Min Buy 1 EA

1lb
BBSLGNX0016
 UPC 865724000220
 Min Buy 1 EA

10lb
BBSLGNX010
 Min Buy 1 EA

20lb
BBSLGNX020
 UPC 865724000282
 Min Buy 1 EA



DAKINE 420

HIGH YIELD SCIENCE

Dry

DaKine 420 Hemp Broadcast Fertilizer

DaKine 420 All Natural Hemp Broadcast Fertilizer is loaded with a broad spectrum of bioavailable minerals and trace elements. Beneficial bacteria are included to assist with soil conditioning.



500lb

DAKHPRO500

UPC 850030593184

Min Buy 1 EA

2,000lb

DAKHPRO2000

UPC 850030593207

Min Buy 1 EA

1,000lb

DAKHPRO1000

UPC 850030593191

Min Buy 1 EA

Water Soluble

DaKine 420 Advanced Growers Kit

Behold, the Advanced Growers Kit! Our new, bigger, badder kit that makes 600 gallons of plant ready nutrients. The Advanced Growers Kit contains everything your garden needs.



6,300g

DAKAGKIT

UPC 728028462197

Min Buy 1 EA



DaKine 420 Atomic Root Powder

Atomic Root Powder is our unique cannabis root-enhancing formula made to grow and maintain massive healthy root system throughout the growing season from start to finish. Our Mad Scientist and his more mildly mad minions are always doing in-house research to grow the ultimate buds with precisely-balanced formulas. We make sure that your plants never run out of the critical nutrients they need from early grow phase, all the way through to final yield.



100g

DAKARP100

UPC 850030593061

Min Buy 20 EA

5,000g

DAKARP5000

UPC 728028347043

Min Buy 1 EA

250g

DAKARP250

UPC 728028347012

Min Buy 4 EA

25kg

DAKARP25KG

UPC 728028399127

Min Buy 1 EA

500g

DAKARP500

UPC 728028347029

Min Buy 4 EA

125kg

DAKARP125KG

UPC 850030593139

Min Buy 1 EA

1,000g

DAKARP1000

UPC 728028347036

Min Buy 4 EA



Water Soluble

DaKine 420 Bio Minerals

Bio Minerals combines the highest quality mineral marijuana nutrients with the best blend of bacteria to deliver a soil inoculant your Mary Jane will appreciate. We pack this biological powerhouse with various strains of bacillus bacteria at 1 billion CFU (colony-forming units) per gram—one of the most highly concentrated mineral-based bacteria blends on the market!



200g

DAKBM200

UPC 850030593078

Min Buy 20 EA

10,000g

DAKBM10KG

UPC 728028352344

Min Buy 1 EA

500g

DAKBM500

UPC 728028352252

Min Buy 4 EA

50kg

DAKBM50KG

UPC 728028352276

Min Buy 1 EA

1,000g

DAKBM1000

UPC 728028352290

Min Buy 4 EA

250kg

DAKBM250KG

UPC 850030593146

Min Buy 1 EA

2,000g

DAKBM2000

UPC 728028352337

Min Buy 4 EA



DaKine 420 CalMag

Hey! It's your cannabis plants here. We have something to say... We know that Coco Coir is a very popular because of its high cation exchange capacity (CEC)—or ability to store and exchange nutes for weed. But if you don't buffer that growing medium with calcium for strong cell walls and magnesium for chlorophyll production, we may turn yellow in protest. We can also tell you that too much sodium and potassium can cause overdosing, and that's no bueno. So do us a favor and treat our Coco Coir (or whatever growing medium you use) with CalMag. It's a delicious 12-2-12 product containing 6% Calcium and 3% Magnesium for consistently beneficial results.



200g

DAKCM200

UPC 850030593047

Min Buy 20 EA

10,000g

DAKCM10KG

UPC 728028467246

Min Buy 1 EA

500g

DAKCM500

UPC 728028467215

Min Buy 4 EA

50kg

DAKCM50KG

UPC 728028467253

Min Buy 1 EA

1,000g

DAKCM1000

UPC 728028467222

Min Buy 4 EA

250kg

DAKCM250KG

UPC 850030593122

Min Buy 1 EA

2,000g

DAKCM2000

UPC 728028467239

Min Buy 4 EA



DaKine 420 Bio-Gold Hemp Fertilizer

Our water-soluble 20-20-20 fertilizer is the only blend on the market that includes live microbes in the blend. Great for supplemental feed regimens, including injector and drip systems.



50lb

DAKBGOLD50

UPC 850030593177

Min Buy 1 EA



DAKINE 420

HIGH YIELD SCIENCE

Water Soluble

DaKine 420 Starter Kit

The Nitro Nutrients Garden Fertilizer 3-Part Starter Kit provides a solid foundation for a healthy garden from start to finish. These 3 Dakine 420 powdered nutrients are the foundation of our entire line of products and is a perfect choice whether you are a beginner or an expert in the garden. This 3-part plant fertilizer kit is easy to use and includes our three core products; Grow, Base and Bloom. These three nutrients work together to give your plants everything they need to flourish from sprout to flower.



600g
DAKSTRKIT
 UPC 728028346770
 Min Buy 1 EA



DaKine 420 Nitro Nutrients Grow

Nitro Nutrients GROW does what the name suggests, to give you the biggest, greenest, most potent cannabis plants on the planet. Our top-rated cannabis nutrients formula for raging marijuana growth combines pure calcium, free of chloride, sodium and heavy metals, with nitrate nitrogen—the most efficient nitrogen source for superior plant growth. Nitro Nutrients GROW makes your plants explode and thrive throughout the growing season. With Nitro Nutrients GROW, your cannabis will reach a new high!



200g DAKGROW200 UPC 850030593009 Min Buy 20 EA	10,000g DAKGROW10KG UPC 728028467185 Min Buy 1 EA
500g DAKGROW500 UPC 728028467154 Min Buy 4 EA	50kg DAKGROW50KG UPC 728028467192 Min Buy 1 EA
1,000g DAKGROW1000 UPC 728028467161 Min Buy 4 EA	250kg DAKGROW250KG UPC 728028467208 Min Buy 1 EA
2,000g DAKGROW2000 UPC 728028467178 Min Buy 4 EA	



DaKine 420 Nitro Nutrients Base

Nitro Nutrients BASE provides the ideal ratios for maximum vegetative growth, leading to fast-flowering results and plants that will just ooze THC. Nitro Nutrients BASE teams up with GROW to provide all the micronutrients needed for accelerated plant growth; when used with BLOOM, BASE promotes healthier, larger buds, flowers & fruits! Whatever the growing environment, Dakine 420 BASE will maximize your yields.



200g DAKBASE200 UPC 850030593016 Min Buy 20 EA	10,000g DAKBASE10KG UPC 728028346725 Min Buy 1 EA
500g DAKBASE500 UPC 728028346695 Min Buy 4 EA	50kg DAKBASE50KG UPC 728028399103 Min Buy 1 EA
1,000g DAKBASE1000 UPC 728028346701 Min Buy 4 EA	250kg DAKBASE250KG UPC 728028352351 Min Buy 1 EA
2,000g DAKBASE2000 UPC 728028346718 Min Buy 4 EA	



DaKine 420 Nitro Nutrients Bloom

BLOOM rounds out the Nitro Nutrients trifecta of cannabis-growing excellence, with top-rated marijuana nutrients. Our super finishing formula supplies NPK in perfect balance (with 3 times more potassium than nitrogen) to assure high yields and trophy buds. You might think of it as the botanical version of the Big Bang! For bodacious buds and phat flowers, Nitro Nutrients BLOOM is the bomb!



200g DAKBLM200 UPC 850030593023 Min Buy 20 EA	10,000g DAKBLM10KG UPC 728028346763 Min Buy 1 EA
500g DAKBLM500 UPC 728028346732 Min Buy 4 EA	50kg DAKBLM50KG UPC 728028399110 Min Buy 1 EA
1,000g DAKBLM1000 UPC 728028346749 Min Buy 4 EA	250kg DAKBLM250KG UPC 728028352283 Min Buy 1 EA
2,000g DAKBLM2000 UPC 728028346756 Min Buy 4 EA	



DAKINE 420

HIGH YIELD SCIENCE

Water Soluble

DaKine 420 Shock and Awe

Successful growers know the importance of abundant phosphorus during the budding and flowering stages. Our Shock and Awe is packed with phosphorus, as 6-42-12, in the perfect ratio with our already killer Bloom Boost formula. Get ready to kiss the sky and never look back—Shock and Awe changes the growing game forever.



200g
DAKSA200
UPC 850030593030
Min Buy 20 EA

500g
DAKSA500
UPC 728028467048
Min Buy 4 EA

1,000g
DAKSA1000
UPC 728028467055
Min Buy 4 EA

2,000g
DAKSA2000
UPC 728028467062
Min Buy 4 EA

10,000g
DAKSA10KG
UPC 728028467079
Min Buy 1 EA

50kg
DAKSA50KG
UPC 728028467086
Min Buy 1 EA

250kg
DAKSA250KG
UPC 850030593115
Min Buy 1 EA



DaKine 420 Sticky Icky Enzymes

Sticky Icky supplements your soil's naturally produced enzymes, to give you a shortcut and a boost to radical oil and resin production.—including enzymes that “stress” your plants, sending them into oil-producing hyperdrive. This doesn't hurt the plant...or your pocketbook, for that matter!



100g
DAKENZ100
UPC 850030593054
Min Buy 20 EA

500g
DAKENZ500
UPC 860002814704
Min Buy 4 EA

1,000g
DAKENZ1000
UPC 860002814728
Min Buy 4 EA

10lb
DAKENZ10
UPC 860002814735
Min Buy 1 EA

25lb
DAKENZ25
UPC 860002814742
Min Buy 1 EA

75lb
DAKENZ75
UPC 860002814759
Min Buy 1 EA

250lb
DAKENZ250
UPC 850030593085
Min Buy 1 EA



DaKine 420 Foliar Science

"It's poetry in motion, sweet as any harmony...she blinded me with science!" Now that you've got that 1982 song in your head, let's talk Foliar Science, our 29-9-9 plant-ready nitrogen delivery supplement. With 26% Urea, the most absorbent form of nitrogen, this product will unlock nutrient lockout, bypassing the soil with a direct foliar application that will knock out nutrient deficiencies. This perfect NPK blend with essential micronutrients will give your plants that luscious, dark-green look, "as deep as any ocean, the elements in harmony."



250g
DAKFOS250
UPC 728028467260
Min Buy 4 EA

500g
DAKFOS500
UPC 728028467864
Min Buy 4 EA

1,000g
DAKFOS1000
UPC 728028346701
Min Buy 4 EA

5,000g
DAKFOS5000
UPC 728028467888
Min Buy 1 EA

25kg
DAKFOS25KG
UPC 850030593092
Min Buy 1 EA



DaKine 420 Tilthy Rich™ Calcium-Plus

Tilthy Rich™ Calcium-Plus hemp fertilizer combines a specially formulated blend of calcium plus zinc and manganese to benefit the soil ecosystem. This unique amendment is chelated with EDTA with a proprietary process that makes it highly soluble and readily available to both soil microbes and plants. Tilthy Rich™ Calcium is specially formulated to breathe life into your soil, protect plants against disease, heat stress and toxicity, and maintain healthy and active soil structure. Because the soil will be working for you, you will likely be able to gradually reduce the amount and cost of amendments needed to maintain productivity.



500g
DAKCAL500
UPC 860002814711
Min Buy 4 EA

1,000g
DAKCAL1000
UPC 860002814766
Min Buy 4 EA

10lb
DAKCAL10
UPC 860002814773
Min Buy 1 EA

25lb
DAKCAL25
UPC 860002814780
Min Buy 1 EA

75lb
DAKCAL75
UPC 860002814797
Min Buy 1 EA

250lb
DAKCAL250
UPC 850030593108
Min Buy 1 EA



DaKine 420 Flat Line™

Flat Line™ is an all-natural insect repellent for hemp that falls under federal guidelines of FIFRA 25(B) Minimum Risk Ingredients. Effective on grasshoppers, mites, aphids, and other agricultural pests. Flat Line™ is the perfect all-natural alternative to harsh EPA-approved chemicals.



8oz
DAKFL8
UPC 728028467895
Min Buy 1 EA

32oz
DAKFL32
UPC 728028352245
Min Buy 4 EA

64oz
DAKFL64
UPC 728028352269
Min Buy 4 EA

5gal
DAKFL5
UPC 850030593214
Min Buy 1 EA

55gal
DAKFL55
UPC 850030593221
Min Buy 1 EA

275gal
DAKFL275
UPC 850030593238
Min Buy 1 EA





Liquid

DYNA-GRO® All-Pro™ Liquid Plant Food 7-7-7

Provides a high nitrate to ammoniacal nitrogen ratio needed to promote shorter internodal spacing resulting in stronger stems. A complete formula that is perfect for hydroponic vegetable and flower production.



1gal	55gal
DYNALL100	DYNALL550
UPC 080359041008	UPC 080359045501
Min Buy 4 EA	Min Buy 1 EA



DYNA-GRO® BLOOM™ Liquid Plant Food 3-12-6

A low nitrogen, high phosphorus concentrate specifically formulated to encourage the development of large, vibrant blooms. It is ideal for roses, orchids, African violets and all other flowering plants. BLOOM™ supplies a balance for low ammoniacal to nitrate nitrogen needed to avoid stem elongation in flowering plants and vegetables. Apply BLOOM™ before flower buds appear to help initiate flowering.



8oz	5gal
DYNBLM008	DYNBLM500
UPC 080359020089	UPC 080359025008
Min Buy 12 EA	Min Buy 1 EA
32oz	15gal
DYNBLM032	DYNBLM150
UPC 080359020324	UPC 080359021505
Min Buy 12 EA	Min Buy 1 EA
1gal	55gal
DYNBLM100	DYNBLM550
UPC 080359021000	UPC 080359025503
Min Buy 4 EA	Min Buy 1 EA



DYNA-GRO® Foliage Pro® Liquid Plant Food 9-3-6

Ideal N-P-K (3-1-2) ratio recommended for tropical foliage plant production and a wide range of other plants. It also supplies a high nitrate to ammoniacal nitrogen ratio needed to promote shorter internodal spacing resulting in stronger stems. This unique formulation eliminates salt build-up when used at recommended rates and is urea free so it won't burn your plants.



8oz	5gal
DYNFOL008	DYNFOL500
UPC 080359060085	UPC 080359065004
Min Buy 12 EA	Min Buy 1 EA
32oz	15gal
DYNFOL032	DYNFOL150
UPC 080359060320	UPC 080359061501
Min Buy 12 EA	Min Buy 1 EA
1gal	55gal
DYNFOL100	DYNFOL550
UPC 080359061006	UPC 080359065509
Min Buy 4 EA	Min Buy 1 EA



DYNA-GRO® Bonsai-Pro™ Liquid Plant Food 7-9-5

Urea free formula designed specifically to encourage healthy growth of bonsai trees. For use on indoor or outdoor plants or in hydroponic systems. Bonsai Pro™ offers balanced growth throughout the plant's life, which can be affected by temperature, light, soil, pruning, watering, and root structure.



8oz
DYNBON008
UPC 080359170081
Min Buy 12 EA



DYNA-GRO® Dyna-HOME-Gro'n Starter Kit

Starter Kit gives the small or new grower a starter kit to include a grower's manual and five products essential for optimum production. It will provide up to 22 plants grown indoors with all the nutrition they will need.



Starter Kit
DYNKITSTR
UPC 080359490325
Min Buy 4 EA



DYNA-GRO® GROW™ Liquid Plant Food 7-9-5

An all purpose complete nutrition concentrate used to promote both foliage and bloom growth. It is urea free and won't burn your plants and is ideal for poor, rocky soils, hydroponics and container grown plants. It is a rapid cure for nutrient deficiencies and helps replenish lost minerals in poor and depleted soils.



8oz	5gal
DYNGRO008	DYNGRO500
UPC 080359010080	UPC 080359015009
Min Buy 12 EA	Min Buy 1 EA
32oz	15gal
DYNGRO032	DYNGRO150
UPC 080359010325	UPC 080359011506
Min Buy 12 EA	Min Buy 1 EA
1gal	55gal
DYNGRO100	DYNGRO550
UPC 080359011001	UPC 080359015504
Min Buy 4 EA	Min Buy 1 EA



DYNA-GRO® Mag Pro® Nutritional Supplement 2-15-4

A unique supplement that can be used with any complete nutrition formula as a blossom booster. The high phosphorus, magnesium and sulfur content of this formula brings out color, fragrance and size in flowers, fruit and many vegetable crops. Growers using reverse osmosis, rain or deionized water benefit from the addition for Mag-Pro® to their watering schedule. Mag-Pro® is a nutrition supplement and should only be used in conjunction with a DYNA-GRO® complete nutrition formula.



8oz	5gal
DYNMAG008	DYNMAG500
UPC 080359080083	UPC 080359085002
Min Buy 12 EA	Min Buy 1 EA
32oz	15gal
DYNMAG032	DYNMAG150
UPC 080359080328	UPC 080359081509
Min Buy 12 EA	Min Buy 1 EA
1gal	55gal
DYNMAG100	DYNMAG550
UPC 080359081004	UPC 080359085507
Min Buy 4 EA	Min Buy 1 EA





Liquid

DYNA-GRO® Orchid-Pro™ 7-9-5

A professional formulation containing all the essential macro and micro nutrients for use on all types of orchids. It provides the right balance of nutrients for healthy growing and flowering.



8oz
DYNORC008
 UPC 080359180080
 Min Buy 12 EA



DYNA-GRO® Pro-Tekt® The Silicon Solution® 0-0-3

A supplement that supplies soluble silicon and potassium to build stronger plant cell walls. Plants supplied with soluble silicon become more tolerant to drought, heat, and cold stresses, bear more and larger fruit. Pro-Tekt® is taken up in the epidermis and cell walls creating a mechanically stronger plant that can support the weight of dense flowers, fruits and vegetables. Can also be used as a surfactant and to raise pH.



8oz
DYNTEK008
 UPC 080359090082
 Min Buy 12 EA

32oz
DYNTEK032
 UPC 080359090327
 Min Buy 12 EA

1gal
DYNTEK100
 UPC 080359091003
 Min Buy 4 EA

5gal
DYNTEK500
 UPC 080359095001
 Min Buy 1 EA

15gal
DYNTEK150
 UPC 080359091508
 Min Buy 1 EA

55gal
DYNTEK550
 UPC 080359095506
 Min Buy 1 EA



DYNA-GRO® ZYME™

Designed to cleanse your plants roots, soil, media and hydroponic systems of plant exudates, bio-film, sludge, slime and algae.



8oz
DYNZYM008
 UPC 080359550081
 Min Buy 12 EA

32oz
DYNZYM032
 UPC 080359550326
 Min Buy 12 EA

1gal
DYNZYM100
 UPC 080359551002
 Min Buy 4 EA

5gal
DYNZYM500
 UPC 080359555000
 Min Buy 1 EA



Propagation

DYNA-GRO® K-L-N Rooting Concentrate™ 0.009-0.011-0.006

A hormone solution containing two rooting hormones, IBA and NAA. K-L-N that is proven to promote vigorous root growth in trees, foliage and flowering plants. Use it for propagating cuttings, air layering and as a transplanting drench for bare-root stock and newly potted plants. Drench, dip or mist your plants for an explosion of new root growth.



8oz
DYNKLN008
 UPC 080359120086
 Min Buy 12 EA

32oz
DYNKLN032
 UPC 080359120321
 Min Buy 12 EA

1gal
DYNKLN100
 UPC 080359121007
 Min Buy 4 EA

5gal
DYNKLN500
 UPC 080359125005
 Min Buy 1 EA



DYNA-GRO® Root Gel®

A unique gel used to promote root formation in the propagation of cuttings. It contains both IBA and NAA hormones plus the right amount of essential minerals in a water soluble gel to get cuttings off to a great start. Root-Gel® applies quickly, easily and thoroughly, surrounding the cutting with a thick coating of protective nutrient gel.



2oz
DYNRTG002
 UPC 080359140022
 Min Buy 12 EA

4oz
DYNRTG004
 UPC 080359140046
 Min Buy 12 EA

8oz
DYNRTG008
 UPC 080359140084
 Min Buy 12 EA

64oz
DYNRTG064
 UPC 080359140640
 Min Buy 6 EA



Accessories

DYNA-GRO® Pump for 8oz Bottle

For controlled dispensing of liquid plant nutrients. Screws onto neck of 8oz bottle.



Fits 8oz Bottles
DYNPMP008
 Min Buy 12 EA



DYNA-GRO® 3/4" Spigot

For use in dispensing liquid plant nutrients from 5gal and 15gal drums. Screws into 3/4" threaded opening in cap.



Fits 5gal and 15gal Drums
DYNSPG001
 Min Buy 1 EA





Liquid

Ecological Laboratories® MICROBE Life Hydroponics® Foliar Spray & Root Dip

Contains Ecto & Endo Mycorrhizal Fungi. Specifically created for foliar applications, root dips and root drenches, combines the high concentration of photosynthetic cultures with natural, rare earth humates and essential elements for improved plant biology. Enhances metabolism plus Increases chlorophyll and nutrient availability. Works well with all nutrient/fertilizer programs and all soil and soilless media.



16oz
ECLPH21348
 UPC 097121213488
 Min Buy 12 EA

1gal
ECLPH21350
 UPC 097121213501
 Min Buy 4 EA



32oz
ECLPH21349
 UPC 097121213495
 Min Buy 12 EA

Ecological Laboratories® MICROBE Life Hydroponics® Nourish-L Liquid Fertilizer

Contains Rare Earth Humates and is certified organic. A unique, liquid conditioner derived from a highly decomposed organic humus deposit. Enhances the ability of plants to absorb nutrients more efficiently, optimizing plant functions and facilitates greater results using less nutrients. Aids in micronutrient uptake, increases water retention and provides vegetative humic acids.



16oz
ECLPH21231
 UPC 097121212313
 Min Buy 12 EA

1gal
ECLPH21233
 UPC 097121212337
 Min Buy 4 EA



32oz
ECLPH21232
 UPC 097121212320
 Min Buy 12 EA

2.5gal
ECLPH21371
 UPC 097121213716
 Min Buy 2 EA

Ecological Laboratories® MICROBE Life Hydroponics® Vegetable & Fruit Yield Enhancer

With Endo Mycorrhizal Fungi. This Bio-Enhancer is a unique, liquid conditioner derived from a highly decomposed organic humus deposit. Enhances the ability of plants to absorb nutrients more efficiently, optimizing plant functions and facilitates greater results using less nutrients. Aids in micronutrient uptake, increases water retention and provides vegetative humic acids.



16oz
ECLPH21345
 UPC 097121213457
 Min Buy 12 EA



32oz
ECLPH21346
 UPC 097121213464
 Min Buy 12 EA

Ecological Laboratories® MICROBE Life Hydroponics® Photosynthesis Plus

All natural. Enhances plant functions at the foliar level and the root zone in both soil and soilless substrates. Enhances photosynthesis and biological function by allowing plants to capture and utilize radiant energy more efficiently. Speeds uptake and distribution of essential macro- and micro- nutrients required for all plant metabolic functions and growth. Promotes plant vigor and reduces input costs while increasing yields.



16oz
ECLPH21226
 UPC 097121212269
 Min Buy 12 EA

1gal
ECLPH21228
 UPC 097121212283
 Min Buy 4 EA



32oz
ECLPH21227
 UPC 097121212276
 Min Buy 12 EA

Ecological Laboratories® MICROBE Life Hydroponics® All-In-One

A specialized formula of micro and macro nutrients that is specially formulated for vegetables and plants of all types. Using this low analysis supplement once or twice weekly will promote larger, brighter, faster blooms, as well as strong, healthy roots.



16oz
ECLPH21363
 UPC 097121213631
 Min Buy 12 EA

1gal
ECLPH21365
 UPC 097121213655
 Min Buy 4 EA



32oz
ECLPH21364
 UPC 097121213648
 Min Buy 12 EA

2.5gal
ECLPH21366
 UPC 097121213662
 Min Buy 2 EA

Ecological Laboratories® MICROBE Life Hydroponics® Foliar Spray & Root Drench for Trees & Shrubs

A high concentration of photosynthetic cultures and endo mycorrhizal fungi, in combination with natural rare earth humates and essential elements, for improved tree and shrub biology.



2.5gal
ECLPH21373
 UPC 097121213730
 Min Buy 2 EA



Ecological Laboratories® MICROBE Life Hydroponics® Photosynthesis Plus

The culture consortium produced by Ecological Laboratories, Inc. that is used on tens of thousands of acres of crops worldwide is the foundation for our Photosynthesis Plus, a complete ecosystem in the bottle. The proprietary formulation and culture growth enhances product performance via selective adaptation, resulting in superior performance in aerobic, facultative, anaerobic and anoxic environments. Shelf stable for two years.



2.5gal
ECLPH21383
 UPC 097121213839
 Min Buy 2 EA





Liquid

Ecological Laboratories® MICROBE Life Hydroponics® Vitamins & Amino Acids

A blend of essential vitamins and amino acids required by many plants and fish, but which may not be present in all water sources or may be removed by some filtration systems.



16oz

ECLPH21367

UPC 097121213679

Min Buy 12 EA

1gal

ECLPH21369

UPC 097121213693

Min Buy 4 EA

32oz

ECLPH21368

UPC 097121213686

Min Buy 12 EA



Ecological Laboratories® MICROBE Life Hydroponics® Premium Nourish-I Illinois Label

Contains Rare Earth Humates and is certified organic. A unique, liquid conditioner derived from a highly decomposed organic humus deposit. Enhances the ability of plants to absorb nutrients more efficiently, optimizing plant functions and facilitates greater results using less nutrients. Aids in micronutrient uptake, increases water retention and provides vegetative humic acids. Supplements water, mineral, carbon and essential element requirements.



16oz

ECLPH21711

UPC 097121217110

Min Buy 12 EA

2.5gal

ECLPH21714

UPC 097121217141

Min Buy 2 EA

32oz

ECLPH21712

UPC 097121217127

Min Buy 12 EA

5gal

ECLPH21816

UPC 097121218162

Min Buy 1 EA

1gal

ECLPH21713

UPC 097121217134

Min Buy 4 EA

Ecological Labs® MICROBE Life Hydroponics® Nourish-L Liquid Fertilizer

Contains Rare Earth Humates and is certified organic. A unique, liquid conditioner derived from a highly decomposed organic humus deposit. Enhances the ability of plants to absorb nutrients more efficiently, optimizing plant functions and facilitates greater results using less nutrients. Aids in micronutrient uptake, increases water retention and provides vegetative humic acids. Supplements water, mineral, carbon and essential element requirements.



5gal

ECLPH21776

UPC 097121217769

Min Buy 1 EA



Ecological Labs® MICROBE Life Hydroponics® Foliar Spray & Root Dip

Contains Ecto & Endo Mycorrhizal Fungi. Specifically created for foliar applications, root dips and root drenches, combines the high concentration of photosynthetic cultures with natural, rare earth humates and essential elements for improved plant biology. Enhances metabolism plus Increases chlorophyll and nutrient availability. Works well with all nutrient/fertilizer programs and all soil and soilless media.



5gal

ECLPH21784

UPC 097121217844

Min Buy 1 EA



Ecological Labs® MICROBE Life Hydroponics® Photosynthesis Plus Fertilizer

All natural. Enhances plant functions at the foliar level and the root zone in both soil and soilless substrates. Enhances photosynthesis and biological function by allowing plants to capture and utilize radiant energy more efficiently. Speeds uptake and distribution of essential macro- and micro-nutrients required for all plant metabolic functions and growth. Promotes plant vigor and reduces input costs while increasing yields.



5gal

ECLPH21772

UPC 097121217721

Min Buy 1 EA





Dry

Espoma® Organic® Bio-Tone® Starter Plus 4-3-3 Plant Food Plus Mycorrhizae

Bio-active plant food with beneficial bacteria, humates plus Mycorrhizae. For enhanced root development. 100% natural and organic approved plant foods. The Tone products are made for complex blends of the finest natural and organic ingredients. No sludges or fillers are ever used. They are enhanced with Bio-Tone beneficial microbes to help plants establish fast, develop deeper roots and have superior blooms. Consistency and quality are guaranteed.



4lb Bag
ESPBTSP4

UPC 050197038041
Min Buy 12 EA



Espoma® Organic® Garden Lime

Turns hydrangeas pink. Adjusts the pH of excessively acid soils. Pelletized for easy application. Much safer than hydrated lime. Comprised of 100% natural and organic ingredients, these products are pure plant food with no fillers or sludge. They enrich your garden with the best the earth has to offer. Approved for organic gardening.



6.75lb
ESPLG6

UPC 050197020060
Min Buy 6 EA



Espoma® Organic® Garden-Tone® 3-4-4

Originally developed for professional gardeners. Provides safe, continuous feeding for all vegetables. 100% natural and organic approved plant foods. The Tone products are made for complex blends of the finest natural and organic ingredients. No sludges or fillers are ever used. They are enhanced with Bio-Tone beneficial microbes to help plants establish fast, develop deeper roots and have superior blooms. Consistency and quality are guaranteed. Long lasting results - won't burn or leach away.



36lb (60/PL)
ESPGT36

UPC 050197003360
Min Buy 1 EA



Espoma® Organic® Rock Phosphate 0-3-0

All natural. Pelletized for easy application. Contains 3% available and 24% total phosphate. Comprised of 100% natural and organic ingredients, these products are pure plant food with no fillers or sludge. They enrich your garden with the best the earth has to offer. Approved for organic gardening.



28lb
ESPRP28

UPC 050197012287
Min Buy 1 EA



Espoma® Organic® Plant-Tone® 5-3-3

An all natural, all purpose premium blend plant food. Excellent as a starter plant food. 100% natural and organic approved plant foods. The Tone products are made for complex blends of the finest natural and organic ingredients. No sludges or fillers are ever used. They are enhanced with Bio-Tone beneficial microbes to help plants establish fast, develop deeper roots and have superior blooms. Consistency and quality are guaranteed. Long lasting results - won't burn or leach away.



4lb

ESPPT4

UPC 050197002042
Min Buy 12 EA



Espoma® Organic® Bone Meal 4-12-0

All natural organic source of Nitrogen and Phosphorus. Bone Meal helps develop sturdy root systems and promotes plant growth, and is ideal as a supplement for bulbs, flowers and roses.



4lb Bag

ESPBMO4

UPC 050197010092
Min Buy 12 EA



Espoma® Organic® Blood Meal 12-0-0

All natural organic source of Nitrogen. Blood Meal promotes rapid growth and deep, dark green color, and is an ideal supplement for all annuals and perennials.



3lb

ESPDB03

UPC 050197013093
Min Buy 12 EA

17lb

ESPDB17

UPC 050197013178
Min Buy 1 EA



Espoma® Organic® Soil Acidifier

Turns Hydrangeas blue, lowers the pH of soils and allows acid loving plants to achieve optimum growth. Long lasting, high effective safe and non-toxic. Comprised of 100% natural and organic ingredients, these products are approved for organic gardening.



30lb

ESPGSUL30

UPC 050197030304
Min Buy 1 EA



Espoma® Organic® Garden Gypsum

Pelletized for easy application. Loosens heavy clay soils. Helps cure turf burns from ice-melters and pets. Comprised of 100% natural and organic ingredients, these products are pure plant food with no fillers or sludge. They enrich your garden with the best the earth has to offer. Approved for organic gardening.



6lb

ESPGG6

UPC 050197022064
Min Buy 6 EA





Liquid

FOOP Bloom 1

Contains all of the potassium, calcium, magnesium, silica, critical minerals and micronutrients and beneficial bacteria that high yielding plants require to flourish in the bloom stage of growth. Promotes the development of more fruits, flowers, and buds.



32oz

FOPAJOFB1PACK5X32O

UPC 793897070873

Min Buy 5 EA

1gal

FOPAKOFB1PACK5X1G

UPC 793897108811

Min Buy 5 EA

5gal

FOPALOFB20115G

UPC 793897125931

Min Buy 1 EA



FOOP Bloom 2

Contains all of the nitrogen and phosphorous that high yielding plants require to flourish in the bloom stage of growth. Promotes the development of more fruits, flowers, and buds.



32oz

FOPAMOFB2PACK5X32O

UPC 793897089837

Min Buy 5 EA

1gal

FOPANOFB2PACK5X1G

UPC 793897155853

Min Buy 5 EA

5gal

FOPAOFB20125G

UPC 793897000450

Min Buy 1 EA



FOOP Sweetener

Promotes accelerated growth of the beneficial bacteria. Improves flavor. Creates an explosion of trichomes.



32oz

FOPAPFCSPACK5X32O

UPC 793897025118

Min Buy 5 EA

1gal

FOPAQFCSPACK5X1G

UPC 793897186086

Min Buy 5 EA

5gal

FOPARFCS008H1605G

UPC 793897065688

Min Buy 1 EA



Liquid

FOOP Starter Pack

Contains FOOP Veg 1, FOOP Veg 2, FOOP Bloom 1, FOOP Bloom 2 and FOOP Sweetener – enough to feed up to 5 larger plants or 10 smaller plants though their entire lifecycle.



32oz

FOPACFCSTPK32OCASE4

UPC 793897173833

Min Buy 4 EA



FOOP Veg 1

Contains all of the potassium, calcium, magnesium, silica, critical minerals and micronutrients, mycorrhizae fungi and beneficial bacteria that high yielding plants require to flourish in the vegetative stage of growth. Promotes root growth, thick stalks, and rapid luscious green topical growth.



32oz

FOPADOFCV1PACK5X32O

UPC 793897165913

Min Buy 5 EA

1gal

FOPAEFCV1PACK5X1G

UPC 793897091571

Min Buy 5 EA

5gal

FOPAFFCV20115G

UPC 793897149685

Min Buy 1 EA



FOOP Veg 2

Contains all of the nitrogen and phosphorous that high yielding plants require to flourish in the vegetative stage of growth. Promotes root growth, thick stalks, and rapid luscious green topical growth.



32oz

FOPAGFCV2PACK5X32O

UPC 793897190892

Min Buy 5 EA

1gal

FOPAHFCV2PACK5X1G

UPC 793897002416

Min Buy 5 EA

5gal

FOPAIOFCV20125G

UPC 793897060362

Min Buy 1 EA



Propagation

FOOP Clone Gel

FOOP Clone Gel is an all-natural rooting and propagation agent made with organic ingredients. Simply dip cuttings into the gel and place in soil flats, cloners, or plant starter cubes of any type.



4oz

FOPAAFCCGASE100ML

UPC 793897020519

Min Buy 20 EA

32oz

FOPABFCGASE32O

UPC 793897081855

Min Buy 8 EA





Dry

Earth Juice® Rainbow Mix™ PRO Bloom

The ultimate plant nutrient. Contains a powerful blend of ingredients with mycorrhizae and other beneficial microbes. Encourages the production of bud and blooms and the result of oils, resins and fragrances. Formulated to be used on indoor and outdoor plants. N 2.00% - P 14.00% - K 2.00% - Ca 12.00%



5 lbs
EXC100210184
 UPC 727644503758
 Min Buy 9 EA

20 lbs
EXC100210185
 UPC 727644503765
 Min Buy 1 EA

40lbs
EXC100210186
 UPC 727644503789
 Min Buy 1 EA



Earth Juice® Rainbow Mix™ PRO Grow 8-6-3

Contains a powerful blend of ingredients with mycorrhizae and other beneficial microbes. Promotes vigorous stem and leaf growth. Formulated to be used on indoor and outdoor plants.



5lbs
EXC100210179
 UPC 727644503550
 Min Buy 9 EA

20lbs
EXC100210180
 UPC 727644503567
 Min Buy 1 EA

40lbs
EXC100210181
 UPC 727644503581
 Min Buy 1 EA



Earth Juice® Seasoned BioChar

Pre-composted BioChar. Beneficial amendment for hosting microbes. Adds carbon back to the media. Unique blend aerates compacted soil. Increases water holding capacity.



1cf
EXC100532270
 UPC 727644001223
 Min Buy 1 EA



Water Soluble

Earth Juice® Bloom Master™

Water-soluble bud'n'bloom booster with rock phosphate and steamed bone meal. Bloom Master is a super concentrated water-soluble bud & bloom plant food & booster designed to increase the production of blooms and improve the development of essential oils, resins and fragrances.



3lbs
EXC100535831
 UPC 727644372729
 Min Buy 16 EA

7lbs
EXC100535832
 UPC 727644372736
 Min Buy 9 EA

20lbs
EXC100535833
 UPC 727644372743
 Min Buy 1 EA

40lbs
EXC100535834
 UPC 727644372781
 Min Buy 1 EA



Earth Juice® Seablast™ Bloom

Plant food containing seaweed, rock phosphate, steamed bone meal and micro-nutrients that enhances buds and blooms.



2lbs
EXC100535803
 UPC 727644351021
 Min Buy 16 EA

5lbs
EXC100535804
 UPC 727644351038
 Min Buy 9 EA

20lbs
EXC100535805
 UPC 727644351045
 Min Buy 1 EA

40lbs
EXC100535806
 UPC 727644351083
 Min Buy 1 EA



Earth Juice® Seablast™ Grow

Formulated with seaweed, rock phosphate, bone meal and micronutrients. SeaBlast Grow promotes the development of sturdy stems and lush leaf growth.



2lbs
EXC100535799
 UPC 727644350826
 Min Buy 16 EA

5lbs
EXC100535800
 UPC 727644001032
 Min Buy 9 EA

20lbs
EXC100535801
 UPC 727644350840
 Min Buy 1 EA

40lbs
EXC100535802
 UPC 727644350888
 Min Buy 1 EA



Earth Juice® Seablast™ Transition

An exclusive plant food formulated to promote stem and leaf growth while supporting the development of buds and blooms and the production of essential oils, resins and fragrances.



2lbs
EXC100536075
 UPC 727644351229
 Min Buy 16 EA

5lbs
EXC100536162
 UPC 727644351236
 Min Buy 9 EA

20lbs
EXC100536076
 UPC 727644351243
 Min Buy 1 EA

40lbs
EXC100536077
 UPC 727644351281
 Min Buy 1 EA





Liquid

Earth Juice® Bloom

Encourages rich flower development. Aids in the creation of essential oils, resins and fragrances of flowering and fruiting plants.



1qt
EXC100535835
UPC 727644510213
Min Buy 12 EA

5gal
EXC100535838
UPC 727644510251
Min Buy 1 EA



1gal
EXC100535836
UPC 727644510220
Min Buy 4 EA

Earth Juice® Grow

Encourages robust vegetative stem and leaf growth. Non-burning and no salt residue. For "hand-feeding" applications only of plants growing in all soils.



1qt
EXC100535840
UPC 727644510718
Min Buy 12 EA

5gal
EXC100535843
UPC 727644510756
Min Buy 1 EA



1gal
EXC100535841
UPC 727644510725
Min Buy 4 EA

Earth Juice® MicroBlast™ Liquid Micronutrients

Prevents and/or corrects micronutrient deficiencies. For use with Earth Juice® Grow and Bloom as well as other liquid and dry soil and hydroponic fertilizers. May be added to reservoirs by hand feeding or used with foliar spray. Formulated to be used on indoor and outdoor plants. N 0.4% - K 1.3% - Mg 0.50% - B 0.02% - Co 0.0005% - Fe 0.10% - Mn 0.05% - Mo 0.0005% - Zn 0.05%



1qt
EXC100210146
UPC 727644132217
Min Buy 12 EA

5gal
EXC100210149
UPC 727644132255
Min Buy 1 EA



1gal
EXC100210147
UPC 727644132224
Min Buy 4 EA

Earth Juice® Meta-K 0-0-5

Natural liquid potassium formulation. Corrects potassium deficiencies or a need for additional potassium.



1gal
EXC100210141
UPC 727644132323
Min Buy 4 EA

5gal
EXC100210142
UPC 727644132354
Min Buy 1 EA



Earth Juice® Hi-Brix Molasses for Plants

72% Brix. Pure premium-grade unsulfured sugar cane molasses. A natural source of carbohydrates (sugars) and plant nutrients. For indoor & outdoor plants in soil or hydroponics. Highly recommended for brewing plant tea



1qt
EXC100209829
UPC 727644083038
Min Buy 12 EA

2.5gal
EXC100209830
UPC 727644083304
Min Buy 2 EA

1gal
EXC100209828
UPC 727644083205
Min Buy 4 EA

5gal
EXC100209831
UPC 727644083076
Min Buy 1 EA



Earth Juice® OilyCann™

A liquid calcium, magnesium and humic acid supplement formulated with zero nitrogen. Can be used alone or together with liquid or dry fertilizers. Recommended for plants with calcium and magnesium deficiencies. Formulated to be used on indoor or outdoor plants through soil or hydroponic systems.



32oz
EXC100210153
UPC 727644131722
Min Buy 12 EA

5gal
EXC100210156
UPC 727644131753
Min Buy 1 EA

1gal
EXC100210154
UPC 727644131739
Min Buy 4 EA



Earth Juice® Xatalyst

"THE CRUCIAL LINK". Encourages compact branching and opulent fruiting sites. Product may settle. Shake vigorously. N 0.03% - P 0.01% - K 0.10%



1qt
EXC100531961
UPC 727644510312
Min Buy 12 EA

5gal
EXC100531964
UPC 727644510350
Min Buy 1 EA

1gal
EXC100531962
UPC 727644510329
Min Buy 4 EA



Earth Juice® Sugar Peak™ Flowering 2-4-5

Encourages luxuriant yields of flowers, fruit and vegetables while enhancing the development of essential oils and fragrances. Contains molasses. Eliminates the need for carbohydrate supplements. Formulated to be used on indoor or outdoor plants in soil and hydroponic systems.



32oz
EXC100535823
UPC 727644371227
Min Buy 12 EA

1gal
EXC100535824
UPC 727644371234
Min Buy 4 EA





Liquid

Earth Juice® Sugar Peak™ Grand Finale™ 0-6-4

Helps maximize the production of essential oils, resins and fragrances. Contains molasses. Eliminate the need for any carbohydrate supplements. Formulated to be used on indoor or outdoor plants in soil or hydroponic systems.



32oz

EXC100535901

UPC 727644371326

Min Buy 12 EA

1gal

EXC100535904

UPC 727644371333

Min Buy 4 EA



Earth Juice® Sugar Peak™ Transition™ 2.7-3.1-2.7

Promotes vigorous stem and leaf growth. Encourages bud and blooms development. Change to Sugar Peak™ Flowering and finish with Sugar Peak™ Grand Finale™.



32oz

EXC100536968

UPC 727644371920

Min Buy 12 EA

1gal

EXC100536969

UPC 727644371937

Min Buy 4 EA



Earth Juice® Sugar Peak™ Vegetative 3-1-5

For energetic stem and leaf growth. Recommended for foliage, plants, leafy vegetables. Contains molasses and eliminates any carbohydrate supplements. Formulated for use on indoor or outdoor plants in soil and hydroponic systems.



32oz

EXC100535807

UPC 727644371029

Min Buy 12 EA

1gal

EXC100535808

UPC 727644371036

Min Buy 4 EA



Liquid

Alaska Fish Emulsion 5-1-1

Rich source of organic matter that breaks down and releases vital nutrients into the soil that enhances the strength and vigor of plants. The natural occurring soil microbes will thrive and work to ensure that the soil is rich in organic matter.



1qt Liquid Concentrate

EXC100099247

UPC 022671400002

Min Buy 12 EA

1gal

EXC100099249

UPC 022671600006

Min Buy 4 EA

5gal

EXC9301205

UPC 022671120597

Min Buy 1 EA





Dry

Malibu Compost Bu's™ Blend Biodynamic® Compost

This compost repairs your soil's ecosystem, saves water, and serves as a source of humus for planting and managing soil health while amending your soil for vegetables, plants, flowers, lawns, and gardens, giving them nutrients they need. For use with native soils or quality potting or planting mixes. Improves clay, compacted, or otherwise poor soils. Ingredients: Dairy cow manure, straw, vineyard wood chips, and biodynamic concentrations of yarrow, chamomile, valerian, stinging nettle, dandelion, and oak bark.



12qt
MAL1002
UPC 705105902876
Min Buy 1 EA

Malibu Compost Compost Tea for Plants, Trees & Shrubs

The compost tea supports the microbes in your soil by giving them the microbial food they need to do their job to "mineralize" the nutrients that are in the organic matter of your soil for uptake into your plants. This process known as mineralization is what creates and grows abundance and vitality in your garden. Compost Teas are simple and easy to use and are one hundred percent organic. It doesn't have any chemicals in it and doesn't smell at all. It is tested for GMOs and best of all, it's made from our Bu's Blend Biodynamic Compost which comes from our beautiful organic farms. It has biodynamic preparations, which enhance and strengthen your soil and plants. Compost tea is the best way for us to mimic nature when it comes to organic gardening! Your lawn will love it! Each teabag makes up to 5 gallons of tea for your plants (20 gallons per package). Enhances beneficial microbial activity on plants and in soil. Improves plant resistance to disease and pests.



Plants, Trees and Shrubs - 4pk / 4 Single-Use Teabags
MAL2001
UPC 705105902777
Min Buy 12 EA

Propagation

Hormodin® 1 Rooting Hormone

Hormodin 1 rooting hormone is a general purpose powder designed for the grower who propagates plants such as roses, carnations, poinsettias, some shrubs and most soft herbaceous plants. (00.1% (IBA). Hormodin enhances rooting, which reduces propagation bench time and plant loss. Hormodin is easy to use, yielding steadfast performance of rooted cuttings and zero disease migration.



1lb
OHP983111
UPC 896531002152
Min Buy 1 EA

Hormodin® 2 Rooting Hormone

Hormodin 2 rooting hormone is prepared specially for propagating many woody and semi-woody plants, including some of the evergreens.(00.3% (IBA) Hormodin enhances rooting, which reduces propagation bench time and plant loss. Hormodin is easy to use, yielding steadfast performance of rooted cuttings and zero disease migration.



1lb
OHP983221
UPC 049961998506
Min Buy 1 CN

Hormodin® 3 Rooting Hormone

Hormodin 3 rooting hormone is prepared specially for propagating the more difficult to root varieties, including many of the evergreens and dormant leafless cuttings. (00.8% (IBA) Hormodin enhances rooting, which reduces propagation bench time and plant loss. Hormodin is easy to use, yielding steadfast performance of rooted cuttings and zero disease migration.



.5lb
OHP983380
UPC 896351002172
Min Buy 1 CN





Dry

GreenGro™ Hybrid Veg 12-12-12

A unique product which combines the potency and solubility of mineral salts with the wholesome benefits of organic ingredients.



2lb
GGBHHV2

UPC 857834003543
Min Buy 6 EA

6lb
GGBHHV6

UPC 857834003499
Min Buy 4 EA

25lb
GGBHHV25

UPC 857834003529
Min Buy 1 EA

40lb
GGBHHV40

UPC 857834003765
Min Buy 1 EA



GreenGro™ Flower Finisher

Our Flower Finisher is intended for use in the final stage of Bloom. Building upon our Pride Lands base bloom, Flower Finisher is formulated for the unique needs of a plant during the final four weeks of flower development. Our Flower Finisher is intended to increase terpene profile and aroma while adding natural weight and density.



2lb
GGBFH8002

UPC 857834003291
Min Buy 10 EA

5lb
GGBFH8005

UPC 857834003222
Min Buy 8 EA

10lb
GGBFH8010

UPC 857834003239
Min Buy 4 EA

35lb
GGBFH8035

UPC 857834003246
Min Buy 1 EA

250lb
GGBFHDRUM

UPC 857834003697
Min Buy 1 EA

1000lb
GGBFHTOTE1

UPC 857834003680
Min Buy 1 EA



GreenGro™ Nature's Brix 0-0-2

Nature's Brix is a premium blend of carbohydrate, simple sugar, rock dust, and other quality ingredients. It is intended to help increase brix levels and resin production. Additionally, Nature's Brix can be used as a microbe food in compost tea production. For best results, use throughout the entire flowering cycle.



2lb
GGBBX7002

UPC 857834003451
Min Buy 10 EA

5lb
GGBBX7005

UPC 857834003307
Min Buy 8 EA

10lb
GGBBX7010

UPC 857834003314
Min Buy 4 EA

25lb
GGBBX7025

UPC 857834003321
Min Buy 1 EA

250lb
GGBBXDRUM1

UPC 857834003703
Min Buy 1 EA



GreenGro™ Earthshine Biochar Blend

Earthshine biochar blend is a fast easy way to boost the performance of new soil, reuse your old soil, and improve effectiveness of compost teas and mycorrhizae products.



2lb
GGBES3002

UPC 857834003017
Min Buy 8 EA

5lb
GGBES3005

UPC 857834003031
Min Buy 4 EA

30lb
GGBES3030

UPC 857834003123
Min Buy 1 EA

250lb
GGBESDRUM

UPC 857834003734
Min Buy 4 EA

1000lb
GGBESTOTE1

UPC 857834003611
Min Buy 1 EA



GreenGro™ Granular Plus Mycorrhizae

GreenGro Granular Plus is a blend of mycorrhizae, beneficial bacteria, kelp and humic. This highly-effective and easy-to-use, all-in-one product will dramatically improve the health and vigor of your root systems. Same great formula as the Ultrafine blend, but intended for soil based applications. GreenGro Granular Plus can be applied at time of transplant for season-long lasting benefits. Granular Plus is also a great ingredient in compost teas and soil mixes.



1lb
GGBMG2001

UPC 861045000055
Min Buy 8 EA

2lb
GGBMG2002

UPC 861045000048
Min Buy 8 EA

15lb
GGBMG2015

UPC 861045000062
Min Buy 2 EA

50lb
GGBMG2050

UPC 861045000079
Min Buy 1 EA



GreenGro™ Hemp Pods 4-1-1

GreenGro Hemp Pod planter packets are an inexpensive and easy way to ensure your new plantings get a vigorous start. The dissolvable pouch allows for a simple and controlled application of fertilizer, humic acid, biochar, and microbes directly to the root zone. The packets are specifically designed for industrial hemp plantings but are equally effective with other field crops.



GGBHP0250
Min Buy 250 EA



GreenGro™ Hybrid Bloom 2-18-18

Hybrid Bloom(2-18-18) is a water-soluble fertilizer containing nitrogen, phosphorus, potassium, and micro-nutrients. Do not apply to crops during periods of stress.



2lb
GGBHHB2

UPC 857834003574
Min Buy 6 EA

6lb
GGBHHB6

UPC 857834003505
Min Buy 4 EA

25lb
GGBHHB25

UPC 857834003512
Min Buy 1 EA

40lb
GGBHHB40

UPC 857834003772
Min Buy 1 EA





Dry

GreenGro™ Green Aminos 0.5-0-2

Green Aminos is a premium blend of amino acids, proteins, and carbohydrates derived from the highest quality ingredients. Green Aminos can be used throughout your plants entire life cycle. Green Aminos is particularly beneficial in the early stages of plant growth.



2lb
GGBGA9002
UPC 857834003345
Min Buy 10 EA

5lb
GGBGA9005
UPC 857834003352
Min Buy 8 EA

10lb
GGBGA9010
UPC 857834003369
Min Buy 4 EA

25lb
GGBGA9025
UPC 857834003376
Min Buy 1 EA

250lb
GGBGADRUM
UPC 857834003710
Min Buy 1 EA



GreenGro™ Pride Lands Bloom/Flower 2-5.5-5.5

Pride Lands Bloom combines turn of the century dry amendment farming techniques, Native American agriculture, and progressive microbe technologies. This dry fertilizer is a complete bloom food that includes good micro and macronutrients along with a healthy PK boost. The formula can be used as a stand-alone bloom food or in conjunction with our innovative Flower Finisher additive.



5lb
GGBFB6005
UPC 857834003208
Min Buy 8 EA

10lb
GGBFB6010
UPC 857834003185
Min Buy 4 EA

35lb
GGBFB6035
UPC 857834003178
Min Buy 1 EA

250lb
GGBFBDRUM1
UPC 857834003673
Min Buy 1 EA

1000lb
GGBFBTOTE1
UPC 857834003659
Min Buy 1 EA

2000lb
GGBFBTOTE2
UPC 857834003666
Min Buy 1 EA



GreenGro™ Premium Ultrafine Myco

GreenGro Ultrafine is a soluble blend of mycorrhizae, beneficial bacteria, kelp and humic. This highly-effective and easy-to-use, all-in-one product will dramatically improve the health and vigor of your root systems. The Ultrafine blend is perfect for hydroponic and soil drench applications. Great for all types of soft rooted plants such as fruits, vegetables, herbs and flowers.



4oz
GGBMB1004
UPC 861045000093
Min Buy 10 EA

8oz
GGBMB1008
UPC 861045000000
Min Buy 6 EA

1lb
GGBMB1001
UPC 861045000017
Min Buy 6 EA

3lb
GGBMB1003
UPC 861045000024
Min Buy 6 EA

15lb
GGBMB1015
UPC 861045000031
Min Buy 2 EA

30lb
GGBMB1050
UPC 861045000086
Min Buy 1 EA



GreenGro™ Pride Lands Veg 6-3-3.5

Our Pride Lands Veg food is a premium blend of dry amendments, microbes, biochar, and mycorrhiza. Building on our commitment to utilizing turn of the century farming methods and Native American agriculture, this fertilizer blend contains the best quality ingredients to supercharge your garden and give your plants a large head start. We highly recommend using this product in and with microbial compost teas each week. Take pride in your soil with Pride Lands Veg food.



5lb
GGBFV5005
UPC 857834003192
Min Buy 8 EA

10lb
GGBFV5010
UPC 857834003161
Min Buy 4 EA

35lb
GGBFV5035
UPC 857834003154
Min Buy 1 EA

250lb
GGBFVDRUM1
UPC 857834003642
Min Buy 1 EA

1000lb
GGBFVTOTE1
UPC 857834003628
Min Buy 1 EA

2000lb
GGBFVTOTE2
UPC 857834003635
Min Buy 1 EA





GROTEK
SCIENCE FOR PLANTS

Dry

Gaia Green All Purpose Fertilizer

GAIA GREEN All Purpose is an excellent product for landscape and garden use. This fertilizer combines the best of our products, creating an outstanding blend for all your fertilizing needs.



500g
GRN786620907
UPC 678662001170
Min Buy 24 EA

20kg
GRN786620904
UPC 678662001149
Min Buy 1 EA

10kg
GRN786620905
UPC 678662001156
Min Buy 1 EA

2kg
GRN786620906
UPC 678662001163
Min Buy 6 EA



Gaia Green Greensand 0-0-0.2

GAIA GREEN Greensand is mined from ancient, nutrient-rich deposits of oceanic sediment. Over time, this sediment developed into glauconite, which is highly effective as a slow-release fertilizer used to improve the mineral content of soil and other growing media. Greensand is gentle on plants and won't cause root burn. Greensand is recommended for use on lawns, household plants, golf courses, greenhouses, nurseries, and urban gardens, and is suitable for all plants.



1.5kg
GRN786620944
UPC 678662001491
Min Buy 6 EA

10kg
GRN786620945
UPC 678662001507
Min Buy 1 EA

20kg
GRN786620946
UPC 678662001514
Min Buy 1 EA



Gaia Green Power Bloom 2-8-4

GAIA GREEN Power Bloom is a high phosphate fertilizer specifically formulated to support prolific flowering and fruiting. As a result, GAIA GREEN Power Bloom is our best fertilizer for root development and for all flowering and fruiting plants.



500g
GRN786620915
UPC 678662001224
Min Buy 24 EA

10kg
GRN786620913
UPC 678662001194
Min Buy 1 EA

2kg
GRN786620914
UPC 678662001217
Min Buy 6 EA

20kg
GRN786620912
UPC 678662001187
Min Buy 1 EA



Gaia Green Basalt Rock Dust

Basalt is a mineral-rich, volcanic rock high in magnesium, iron, calcium and silica.



22.68kg
GRN786626055
UPC 678662001255
Min Buy 1 EA

2kg
GRN786620012
UPC 678662001262
Min Buy 6 EA



Gaia Green Glacial Rock Dust Fertilizer

GAIA GREEN Glacial Rock Dust is sourced from mineral deposits left by moving glaciers during the last ice age. This natural fertilizer contains essential plant nutrients that support strong plant growth, and can be used on all plants in home gardens, landscapes, lawn, and turf. GAIA GREEN Glacial Rock Dust can also be added to compost piles to help optimize nutrient conditions for root growth and overall plant development.



50g
GRN786620919
UPC 678662001293
Min Buy 24 EA

10kg
GRN786620917
UPC 678662001279
Min Buy 1 EA

2kg
GRN786620918
UPC 678662001286
Min Buy 6 EA

22.68kg
GRN786620916
UPC 678662600250
Min Buy 1 EA



Gaia Green Mineralized Phosphate 0-9-0

GAIA GREEN ORGANICS Mineralized Phosphate is mined from caves and has a potent phosphorus content. Mineralized Phosphate has been known since ancient times to be a highly beneficial natural fertilizer. It provides nutrients to encourage large and plentiful blooms in your flowering plants.



2kg
GRN786620941
UPC 678662001460
Min Buy 6 EA

20g
GRN786620943
UPC 678662001484
Min Buy 1 EA

10kg
GRN786620942
UPC 678662001477
Min Buy 1 EA



Gaia Green Super Fly Insect Frass 3-1-2

GAIA GREEN Super Fly Insect Frass is a fertilizer derived from the excreta of black soldier fly larvae. It is a renewable resource produced from pre-consumer food waste fed to fly larvae. Though new to growers, this digested material has played a significant role in plant nutrition for millions of years. Gaia Green Super Fly Insect Frass is rich in essential nutrients.



250g
GRN786620923
UPC 678662001330
Min Buy 24 EA

10kg
GRN786620921
UPC 678662001316
Min Buy 1 EA

750g
GRN786620976
UPC 678662001828
Min Buy 6 EA

17kg
GRN786620978
UPC 678662001842
Min Buy 1 EA

1kg
GRN786620922
UPC 678662001323
Min Buy 6 EA





GROTEK
SCIENCE FOR PLANTS

Dry

Grotek™ Biofuse™

Biofuse™ is a water-soluble inoculant containing microorganisms that come to life when applied to soil. These beneficial microbes colonize the soil immediately surrounding plant roots, adding biodiversity that is often lacking in soilless environments.



100g
GRN770006899
UPC 670829223364
Min Buy 12 EA

600g
GRN770006901
UPC 670829223388
Min Buy 6 EA



300g
GRN770006900
UPC 670829223371
Min Buy 6 EA

Grotek™ Blossom Blaster™ 1-4-0

A concentrated formula that provides abundant nutrients for rapidly developing flowering sites. This formula uses high-grade ingredients to support flowering plants. Blossom Blaster™ is designed to provide the nutrients necessary to support prolific flowering and bud filling for high quality yields.



20g - 15/box
GRN770006245
UPC 670829208071
Min Buy 1 EA

1kg
GRN770006248
UPC 670829208101
Min Buy 6 EA



130g
GRN770006246
UPC 670829208088
Min Buy 12 EA

2.5kg
GRN770006249
UPC 670829208118
Min Buy 1 EA

500g
GRN770006247
UPC 670829208095
Min Buy 6 EA

Grotek™ Monster Bloom™ 0-50-30

Monster Bloom™ is packed full of essential nutrients that all plants crave as they strive to maximize yield. This highly concentrated formula provides a powerful punch to plants and supplies the nutrients necessary to support the flowering and ripening stages.



20g - 15/Box
GRN770006276
UPC 670829208385
Min Buy 1 EA

2.5kg
GRN770006279
UPC 670829208415
Min Buy 1 EA



130g
GRN770006277
UPC 670829208392
Min Buy 12 EA

5kg
GRN770006280
UPC 670829208422
Min Buy 1 EA

500g
GRN770006278
UPC 670829208408
Min Buy 6 EA

10kg
GRN770006281
UPC 670829208439
Min Buy 1 EA

Grotek™ Growth Booster™ 16-40-0

Growth Booster™ is a fully soluble, high nitrogen and phosphorus fertilizer for vigorous vegetative growth. Supplementing your existing fertility program with Growth Booster ensures a strong crop with improved leaf, shoot, and root development.



20g
GRN770006330
UPC 670829224880
Min Buy 12 EA

300g
GRN770006301
UPC 670829208637
Min Buy 6 EA



Grotek™ Carbo Max™ 0-0-1

Simple sugars are a great way to impact the root zone of plants and provide the energy required to produce a quality harvest. Carbo-Max™ is based on simple sugars that provide a rapid energy source for soil organisms and plants, which enhances the metabolism of minerals to positively impact the ripening stage. Use throughout the blooming cycle with every fertilizer application/nutrient change.



100g
GRN770006258
UPC 670829208200
Min Buy 12 EA

700g
GRN770006260
UPC 670829208224
Min Buy 6 EA



300g
GRN770006259
UPC 670829208217
Min Buy 6 EA

Grotek™ Monster Grow Pro™ 18-36-1

Monster Grow™ Pro is formulated with nutrient ratios to support lush green growth, improved root development, and stronger plant structure. This water-soluble powder contains a blend of mineral and organic nutrients that are essential for vigorous plant growth.



20g
GRN770006217
UPC 670829207791
Min Buy 1 EA

2.5kg
GRN770006220
UPC 670829207821
Min Buy 1 EA



130g
GRN770006218
UPC 670829207807
Min Buy 12 EA

5kg
GRN770006221
UPC 670829207838
Min Buy 1 EA

500g
GRN770006219
UPC 670829207814
Min Buy 6 EA

10kg
GRN770006222
UPC 670829207845
Min Buy 1 EA

Grotek™ Synergy™

Synergy™ is a clay-based powder containing fungi. Fungi helps plants achieve explosive root development and improve overall soil conditions for increased plant vigor, all the way to harvest. The mycorrhizal species found in Synergy™ is particularly effective in intensive agriculture when using fertilizers.



140g
GRN770006663
UPC 670829222206
Min Buy 12 EA

800g
GRN770006665
UPC 670829222220
Min Buy 6 EA



400g
GRN770006664
UPC 670829222213
Min Buy 6 EA



GROTEK
SCIENCE FOR PLANTS

Liquid

Grotek™ Biofuse™ POS Display Box

Biofuse™ is a water-soluble inoculant containing microorganisms that come to life when applied to soil. These beneficial microbes colonize the soil immediately surrounding plant roots, adding biodiversity that is often lacking in soilless environments.



15pc - 40g
GRN770007005
UPC 670829223357
Min Buy 1 DS



Grotek™ Synergy™ POS Display Box

Synergy™ is a clay-based powder containing fungi. Fungi helps plants achieve explosive root development and improve overall soil conditions for increased plant vigor, all the way to harvest. The mycorrhizal species found in Synergy™ is particularly effective in intensive agriculture when using fertilizers.



15pc - 40g
GRN770007007
UPC 670829224422
Min Buy 1 DS



Grotek™ Bloom Pack™

The Grotek™ Bloom Pack™ contains Bud Fuel Pro™ 500 ml (x1), Heavy Bud Pro™ 500ml (x1), Vitamax Pro™ 500ml (x1), Monster Bloom™ 20g (x2), Blossom Blaster Pro™ 125ml (x1), Solo-Tek Bloom™ 800ml (x2).



GRN770006316
UPC 670829208743
Min Buy 1 EA



Grotek™ Mega Pack™

The Grotek™ Mega Pack™ contains Solo-Tek Grow™ 1L (x1), Solo-Tek Bloom™ 1L (x1), Monster Grow™ Pro 20g (x1), Bud Fuel™ Pro 1L (x1), Heavy Bud™ Pro 1L (x1), Vitamax™ Pro 1L (x1), Monster Bloom™ 130g (x1), Blossom Blaster™ Pro 125ml (x2), Product Guide (x1).



GRN20107957
UPC 670829800398
Min Buy 1 EA



Grotek™ Blossom Blaster Pro™ 1-4-0

Formulated to support profuse blooms and flower production, this concentrated formula requires a low application rate to achieve a high impact on young flower buds. Through a unique phosphorus nutrient complex, this product optimizes conditions for improved fruit and yields. Commence use during floral initiation before or at bud break. Apply 2-3 times per crop cycle, between bud break and fruit set.



500ml
GRN770006187
UPC 670829207494
Min Buy 6 EA

1L
GRN770006188
UPC 670829207500
Min Buy 6 EA

4L
GRN770006189
UPC 670829207517
Min Buy 4 EA

10L
GRN770006190
UPC 670829207524
Min Buy 2 EA

23L
GRN770006191
UPC 670829207531
Min Buy 1 EA



Grotek™ Bud Fuel Pro™ 1-3-4

This formula optimizes soil nutrient conditions for improved flower development and root structure. By ensuring nutrient availability, Bud Fuel Pro™ provides the foundation for abundant blooms. Using during pre-flower and through early bloom development can encourage prolific blooming for all flowering and fruiting plants. Use 3-4 times during a growing season, focusing immediately prior to and during flower development. Apply as a root drench.



500ml
GRN770006197
UPC 670829207593
Min Buy 6 EA

1L
GRN770006198
UPC 670829207609
Min Buy 6 EA

4L
GRN770006199
UPC 670829207616
Min Buy 4 EA

10L
GRN770006200
UPC 670829207623
Min Buy 2 EA

23L
GRN770006201
UPC 670829207630
Min Buy 1 EA



Grotek™ Cal Max™ 2-0-0

Cal-Max™ works to charge soilless media and bring plants back from common minor nutrient deficiencies resulting from nutrient imbalance, rapid growth, or overly humid conditions. A must for growers using coir based soils. Available nitrogen fuels chlorophyll and protein production to quickly re-green starved plants. Chelated iron adds more deficiency fighting power for lush green growth. Added calcium helps to improve plant vigor and assist in times of peak growth.



500ml
GRN770006255
UPC 670829208170
Min Buy 6 EA

1L
GRN20105306
UPC 670829815132
Min Buy 6 EA

4L
GRN20105307
UPC 670829815125
Min Buy 4 EA

10L
GRN20105305
UPC 670829817051
Min Buy 2 EA

23L
GRN20107882
UPC 670829817068
Min Buy 1 EA





GROTEK
SCIENCE FOR PLANTS

Liquid

Grotek™ Final Flush™

Final Flush™ is formulated to remove excess salt from growing media to ensure a cleaner tasting harvest. Plants tend to absorb excess nutrients and store them in plant tissues. By purging nutrients from the root zone, plants are forced to convert accumulated salts into secondary metabolites that improve harvest quality.



1L - Regular

GRN60100750

UPC 670829806116

Min Buy 6 EA

4L - Regular

GRN60100751

UPC 670829806123

Min Buy 4 EA



Grotek™ Core™ 3-2-3

Core™ is based on plant matter, which not only provides key nutrients but also plant and mineral derived metabolites. This formula can be used to support beneficial soil biology in the rhizosphere, increasing production of substances known to benefit plant growth. Core™ is suitable for all types of growing from gardens to water-based hydroponic systems.



500ml

GRN770006527

UPC 670829216427

Min Buy 6 EA

1L

GRN770006528

UPC 670829216434

Min Buy 6 EA

4L

GRN770006529

UPC 670829216441

Min Buy 4 EA

10L

GRN770006530

UPC 670829216458

Min Buy 2 EA

23L

GRN770006531

UPC 670829216465

Min Buy 1 EA



Grotek™ Growth Max™ 0.1-0.9

Growth Max™ is a highly concentrated, cold-processed kelp rich in organic compounds and minerals. This product helps plants in all stages to achieve their maximum potential. The carbohydrates found in kelp also help support soil microorganisms, which in turn provide key compounds directly to plant roots.



500ml

GRN770006590

UPC 670829217059

Min Buy 6 EA

1L

GRN770006591

UPC 670829217066

Min Buy 6 EA

4L

GRN770006592

UPC 670829217073

Min Buy 4 EA

10L

GRN770006593

UPC 670829217080

Min Buy 2 EA

23L

GRN770006594

UPC 670829217097

Min Buy 1 EA



Grotek™ Heavy Bud Pro™ 1-0-3

Heavy Bud™ Pro contains a fusion of ingredients to improve metabolism, sugar content, essential oils and key metabolites. The nutrients in this formula support improved flavour, aroma, and shelf life. Heavy Bud Pro is meant for use during the mid to late stages of floral development when plants focus on flower density and fruit quality.



500ml

GRN770006207

UPC 670829207692

Min Buy 6 EA

1L

GRN770006208

UPC 670829207708

Min Buy 6 EA

4L

GRN770006209

UPC 670829207715

Min Buy 4 EA

10L

GRN770006210

UPC 670829207722

Min Buy 2 EA

23L

GRN770006211

UPC 670829207739

Min Buy 1 EA



Grotek™ Insta-Green™ 3-0-0

Insta-Green™ is focused on restoring the green to nutrient-deficient plants. Its fast-acting impact provides a quick turnaround into high-yielding growth. This product supplies soluble nitrogen, calcium, magnesium and iron for immediate nutrient replenishment. Best used as a foliar spray for quick effect, but is also great as a root drench, and can even be used as a preventative measure.



500ml

GRN770006265

UPC 670829208279

Min Buy 6 EA

1L

GRN110100729

UPC 670829808042

Min Buy 6 EA

4L

GRN110100730

UPC 670829808059

Min Buy 4 EA

10L

GRN770006266

UPC 670829208286

Min Buy 2 EA



Grotek™ Micro Power™ 0-0-2

Micro Power™ provides a precise ratio of essential trace elements. This ratio is complemented by high levels of magnesium and sulphur to boost critical plant functions. Added potassium assists with overall plant development and crop ripening.



500ml

GRN770006548

UPC 670829216632

Min Buy 6 EA

1L

GRN770006549

UPC 670829216649

Min Buy 6 EA

4L

GRN770006550

UPC 670829216656

Min Buy 4 EA

10L

GRN770006551

UPC 670829216663

Min Buy 2 EA

23L

GRN770006552

UPC 670829216670

Min Buy 1 EA





GROTEK
SCIENCE FOR PLANTS

Liquid

Grotek™ Precision™ Bloom 0-6-4

Grotek™ Precision™ Bloom is part of a complete nutrient package when combined with Precision™ Grow and Precision™ Micro components. The 3-part Precision™ base nutrients are designed to be a full-cycle fertilizer package, suitable for soilless and hydroponic production systems



500ml
GRN770006806
UPC 670829222435
Min Buy 6 EA

1L
GRN770006807
UPC 670829222442
Min Buy 6 EA

4L
GRN770006808
UPC 670829222459
Min Buy 4 EA

10L
GRN770006809
UPC 670829222466
Min Buy 2 EA

23L
GRN770006810
UPC 670829222473
Min Buy 1 EA



Grotek™ Precision™ Grow 3-1-4

Grotek™ Precision™ Grow is part of a complete nutrient package when combined with Precision™ Bloom and Precision™ Micro components. The 3-part Precision™ base nutrients are designed to be a full-cycle fertilizer package, suitable for soilless and hydroponic production systems.



500ml
GRN770006796
UPC 670829222336
Min Buy 6 EA

1L
GRN770006797
UPC 670829222343
Min Buy 6 EA

4L
GRN770006798
UPC 670829222350
Min Buy 4 EA

10L
GRN770006799
UPC 670829222367
Min Buy 2 EA

23L
GRN770006800
UPC 670829222374
Min Buy 1 EA



Grotek™ 900ml Black Pearl

Black Pearl™ is high-quality charcoal laden with high-grade ingredients like biochar, volcanic rock dust, low molecular weight humates, and kelp, which provides a dramatic boost to crops when added to any nutrient program.



900ml
GRN770006516
UPC 670829215932
Min Buy 6 EA

10L
GRN770006518
UPC 670829215789
Min Buy 2 EA

17L
GRN770006519
UPC 670829215796
Min Buy 1 EA



Grotek™ Precision™ Micro 4-0-2

Grotek™ Precision™ Micro is part of a complete nutrient package when combined with Precision™ Grow and Precision™ Bloom components. The 3-part Precision™ base nutrients are designed to be a full-cycle fertilizer package, suitable for soilless and hydroponic production systems.



500ml
GRN770006816
UPC 670829222534
Min Buy 6 EA

1L
GRN770006817
UPC 670829222541
Min Buy 6 EA

4L
GRN770006818
UPC 670829222558
Min Buy 4 EA

10L
GRN770006819
UPC 670829222565
Min Buy 2 EA

23L
GRN770006820
UPC 670829222572
Min Buy 1 EA



Grotek™ Pro-Silicate™ 0-0-4

With a high concentration of soluble potash and silica, Pro-Silicate™ was developed for use in soilless media and hydroponic systems where these elements may be lacking. While not considered an essential nutrient, plants accumulate silica in macro proportions for good reason. Silica is known to strengthen cell walls and overall cell integrity, which makes plants more resistant to abiotic stress such as heat and drought.



500ml
GRN770006288
UPC 670829208507
Min Buy 6 EA

1L
GRN770006289
UPC 670829208514
Min Buy 6 EA

4L
GRN770006290
UPC 670829208521
Min Buy 4 EA

10L
GRN770006291
UPC 670829208538
Min Buy 2 EA

23L
GRN770006292
UPC 670829208545
Min Buy 1 EA



Grotek™ Root Force™ 1-0-0

Root Force™ aids in providing optimal nutrient conditions for the development of important secondary root structures. These structures can improve nutrient uptake, support connections with mycorrhizae, and build stronger plants by contributing to a more robust root system. This formula can help provide a buffer against abiotic environmental pressure such as drought and under-watering, giving plants a chance to bounce back quicker from stressful conditions. Root Force™ is designed to support biology, especially bacteria.



500ml
GRN770006632
UPC 670829217479
Min Buy 6 EA

1L
GRN770006633
UPC 670829217486
Min Buy 6 EA

4L
GRN770006634
UPC 670829217493
Min Buy 4 EA

10L
GRN770006635
UPC 670829217509
Min Buy 2 EA

23L
GRN770006636
UPC 670829217516
Min Buy 1 EA





GROTEK
SCIENCE FOR PLANTS

Liquid

Grotek™ Rype™ 3-0-0

Rype™ is designed to support high harvest quality and produce a more flavourful yield. This formula provides optimal nutrient conditions to support the energy intensive ripening stage, and provides beneficial compounds such as carbohydrates to support soil microbes.



500ml

GRN770006611

UPC 670829217264

Min Buy 6 EA

1L

GRN770006612

UPC 670829217271

Min Buy 6 EA

4L

GRN770006613

UPC 670829217288

Min Buy 4 EA

10L

GRN770006614

UPC 670829217295

Min Buy 2 EA

23L

GRN770006615

UPC 670829217301

Min Buy 1 EA



Grotek™ Solo-Tek Bloom™ 3-8-8

A one-part bloom fertilizer that is easy to use and highly effective on a range of crops. Solo-Tek Bloom™ provides optimum nutrient ratios for prolific flowering and fruiting. Highly effective as a stand-alone fertilizer; the results are even more explosive when used with supplements.



500ml

GRN10104362

UPC 670829820136

Min Buy 6 EA

1L

GRN10104369

UPC 670829818348

Min Buy 6 EA

4L

GRN10104372

UPC 670829818355

Min Buy 4 EA

10L

GRN10104373

UPC 670829818362

Min Buy 2 EA



Grotek™ Solo-Tek Grow™ 6-3-7

A one-part growth fertilizer that is easy-to-use and highly effective on a range of crops. Solo-Tek Grow™ is designed to provide the nutrients required to grow a lush canopy full of potential. This formula is a proprietary mix of mineral components and organic matter, and powers vigorous growth as a stand-alone fertilizer. The results are even more explosive when used with supplements.



500ml

GRN10104361

UPC 670829208736

Min Buy 6 EA

1L

GRN10104370

UPC 670829818249

Min Buy 6 EA

4L

GRN10104371

UPC 670829818256

Min Buy 4 EA

10L

GRN10104374

UPC 670829818263

Min Buy 2 EA



Grotek™ Vital™ 5% Calcium

Grotek™ Vital™ calcium fertilizer allows growers to get the level of calcium just right for their plants. As an isolated component, it is possible to dial in a precise level of calcium. The formula also has ultra-low chloride content for better plant and soil vitality. Vital™ is an excellent choice for all gardens, but is a necessity when growing in Coco.



500ml

GRN770006569

UPC 670829216847

Min Buy 6 EA

1L

GRN770006570

UPC 670829216854

Min Buy 6 EA

4L

GRN770006571

UPC 670829216861

Min Buy 4 EA

10L

GRN770006572

UPC 670829216878

Min Buy 2 EA

23L

GRN770006573

UPC 670829216885

Min Buy 1 EA



Grotek™ Vitamax Plus™ 1-1-2

As a full cycle fertilizer, Vitamax Plus™ contains essential nutrients and improves efficacy of any base nutrient. Key inputs support plant foliage and flower development. With low organic matter, this formula was designed for use in water culture systems.



500ml

GRN770006304

UPC 670829207913

Min Buy 6 EA

1L

GRN770006305

UPC 670829207920

Min Buy 6 EA

4L

GRN770006306

UPC 670829207937

Min Buy 4 EA

10L

GRN770006307

UPC 670829207944

Min Buy 2 EA

23L

GRN770006308

UPC 670829207951

Min Buy 1 EA



Grotek™ Vitamax Pro™ 1-1-1

Vitamax™ Pro provides soil and soilless gardens with key organic matter to help drive plant production. Nutrients from land and sea provide array of minerals to help plants build bigger roots, stronger shoots, and incredible flowers.



500ml

GRN770006235

UPC 670829207975

Min Buy 6 EA

1L

GRN770006236

UPC 670829207982

Min Buy 6 EA

4L

GRN770006237

UPC 670829207999

Min Buy 4 EA

10L

GRN770006238

UPC 670829208002

Min Buy 2 EA

23L

GRN770006239

UPC 670829208019

Min Buy 1 EA





Liquid

Terpify Essential Oil Intesifier

Terpify is formulated from all natural botanical extracts and is designed to assist the plant with processes associated with oil and resin production. All natural inputs aimed at enhancing the aromatic experience of cultivation.

Terpify Original Essential Oil Intesifier

Terpify Original is used for most strain profiles that include citrus elements.



1pt
TPZGSTERPP
UPC 850030810007
Min Buy 24 EA

32oz Bottle
TPZGSTERPQ
UPC 850030810014
Min Buy 12 EA

1gal Bottle
TPZGSTERPG
UPC 850030810021
Min Buy 4 EA

2.5gal Bottle
TPZGSTERP2G
UPC 850030810038
Min Buy 2 EA

5gal Bottle
TPZGSTERP5G
UPC 850030810045
Min Buy 1 EA

15gal
TPZGSTERP15G
UPC
Min Buy 1 EA

55gal
TPZGSTERPD
UPC 850030810267
Min Buy 1 EA

250gal
TPZGSTERPT
UPC 850030810274
Min Buy 1 EA



Terpify Berry Essential Oil Intesifier

Terpify Berry, designed to enhance the terpene profile of berry and sweet strains.



1pt
TPZGSTERBPB
UPC 850030810199
Min Buy 24 EA

32oz Bottle
TPZGSTERPBQ
UPC 850030810182
Min Buy 12 EA

1gal Bottle
TPZGSTERPBG
UPC 850030810175
Min Buy 4 EA

2.5gal Bottle
TPZGSTERPB2G
UPC 850030810168
Min Buy 2 EA

5gal Bottle
TPZGSTERPB5G
UPC 850030810151
Min Buy 1 EA

15gal
TPZGSTERPB15G
UPC
Min Buy 1 EA

55gal
TPZGSTERPBD
UPC 850030810205
Min Buy 1 EA

250gal
TPZGSTERPBT
UPC 850030810212
Min Buy 1 EA



Terpify Citrus Essential Oil Intesifier

Terpify Citrus specifically targets citrus dominant strains with d-limonene.



1pt
TPZGSTERPCP
UPC 850030810083
Min Buy 24 EA

32oz Bottle
TPZGSTERPCQ
UPC 850030810090
Min Buy 12 EA

1gal Bottle
TPZGSTERPCG
UPC 850030810076
Min Buy 4 EA

5gal Bottle
TPZGSTERPC5G
UPC 850030810052
Min Buy 1 EA

15gal
TPZGSTERPC15G
UPC
Min Buy 1 EA

55gal
TPZGSTERPCD
UPC 850030810243
Min Buy 1 EA

250gal
TPZGSTERPCT
UPC 850030810250
Min Buy 1 EA



Terpify Pine/Earth Essential Oil Intesifier

Terpify Pine/Earth is formulated for strain profiles high in myrcene and pinene.



1pt
TPZGSTERPEP
UPC 850030810106
Min Buy 24 EA

32oz Bottle
TPZGSTERPEQ
UPC 850030810113
Min Buy 12 EA

1gal Bottle
TPZGSTERPEG
UPC 850030810120
Min Buy 4 EA

2.5gal Bottle
TPZGSTERPE2G
UPC 850030810137
Min Buy 2 EA

5gal Bottle
TPZGSTERPE5G
UPC 850030810144
Min Buy 1 EA

15gal
TPZGSTERPE15G
UPC
Min Buy 1 EA

55gal
TPZGSTERPED
UPC 850030810229
Min Buy 1 EA

250gal
TPZGSTERPET
UPC 850030810236
Min Buy 1 EA



Terpify Essential Oil Intesifier Mixed Pack

Pack includes 12 quarts total: 3 Original, 3 Berry, 3 Pine and 3 Citrus.



12 pack
TPZMIXQT
UPC 850030810306
Min Buy 1 DS



Liquid

HDI Europonic Nitrozime® Marine Algae Extract

Europonic Nitrozime® Marine Algae Extract is a plant nutrient supplement derived exclusively from a natural form of marine algae known as Ascophyllum Nodosum. It contains over 50 naturally occurring trace minerals and macro nutrients. Long known to farmers for its rich value, seaweed has been used for centuries in coastal communities as a natural way to feed plants. At the root level Nitrozime is a seaweed extract that provides food for beneficial soil microbe activity while providing important nutrients to plants. When used as a foliar spray with Europonic Fossil Fuel, Nitrozime is quickly absorbed through leaves of plants providing immediate beneficial results. Europonic Nitrozime Marine Algae Extract is extremely concentrated, eight times more so than common seaweed fertilizer, and contains many of the naturally produced nutrients that all plants require for vigorous growth.



1gal
HDINITGAL
UPC 659627003033
Min Buy 4 EA

32oz
HDINITQT
UPC 659627003026
Min Buy 12 EA

2.5gal
HDINIT25GAL
UPC 659627000643
Min Buy 2 EA

5gal
HDINIT5GAL
UPC 659627000650
Min Buy 1 EA

55gal
HDINIT55GAL
UPC 659627000742
Min Buy 1 EA



HDI Europonic® FossilFuel® Liquid Humic Acids

Created from the highest quality humic acids, which provide complex interactions with soils, potting mixes, and organic hydroponic media to promote healthy soils and growing media which in turn helps to produce lush plant growth and expansive root systems. Biologically, humic acids increase production of plant enzymes; act as an organic catalyst in biological processes; stimulate the production of micro-organisms; enhance natural resistance against plant disease and pests; aid in the uptake of nutrients through improved permeability of plant cells; provide building blocks for sugars, amino acids, and chlorophyll; stimulate plant growth by increasing cell division; and improve yields by decreasing plant stress.



32oz
HDIFOSQT
UPC 659627008007
Min Buy 12 EA

1gal
HDIFOSGAL
UPC 659627008014
Min Buy 4 EA

2.5gal
HDIFOS25GAL
UPC 659627008021
Min Buy 2 EA

5gal
HDIFOS5GAL
UPC 659627008038
Min Buy 1 EA

55gal
HDIFOS55GAL
UPC 659627000735
Min Buy 1 EA



HDI Europonic® Silicate

Serious growers know that silica is important to overall plant health. The benefits of using a silica plant nutrient supplement can be experienced by plants in any stage of the life cycle, including the clone or seedling stage. Europonic Silicate has 11% Silicon Dioxide, making it one of the strongest potassium silicate products on the market.



1qt
HDISILQT
UPC 659627015005
Min Buy 12 EA

1gal
HDISILGAL
UPC 659627015012
Min Buy 4 EA

2.5gal
HDISIL25GAL
UPC 659627015029
Min Buy 2 EA

5gal
HDISIL5GAL
UPC 659627015036
Min Buy 1 EA

55gal
HDISIL55GAL
UPC 659627000759
Min Buy 1 EA



HDI Ionic® Bloom for Soil Premium Plant Nutrient 2-2-5

Ionic® Bloom for Soil contains the highest quality minerals and is powerfully enriched with naturally occurring plant acids that increase overall nutrient uptake and enhance growth and yields of virtually every plant. Ionic® Bloom for Soil is ideal for all container grown plants.



32oz
HDIIONSBLQT
UPC 659627000285
Min Buy 12 EA

1gal
HDIIONSBLGAL
UPC 659627000278
Min Buy 4 EA

2.5gal
HDIIONSBL25GAL
UPC 659627000315
Min Buy 2 EA

5gal
HDIIONSBL5GAL
UPC 659627000322
Min Buy 1 EA

55gal
HDIIONSBL55GAL
UPC 659627000841
Min Buy 1 EA



HDI Ionic® Bloom Plant Nutrient 3-2-6

Enhanced with the crucial elements that support increased budding points and large, fragrant flowers. Specifically formulated for the reproductive and flowering stage of growing plants, it delivers the essential elements to the roots of a plant in a more precise manner than all previous hydroponic formulations. It is derived from 100% pure elemental mineral salts including calcium nitrate, potassium nitrate, phosphoric acid, nitric acid, potassium sulfate, and ammonium nitrate. Ionic® Bloom has a highly stable pH due to the unique reactive buffering incorporated into the quality controlled manufacturing process, reducing pH fluctuations in the reservoir.



32oz
HDIIONBLQT
UPC 659627000056
Min Buy 12 EA

1gal
HDIIONBLGAL
UPC 659627000063
Min Buy 4 EA

2.5gal
HDIIONBL25GAL
UPC 659627000070
Min Buy 2 EA

5 gallon
HDIIONBL5GAL
UPC 659627000087
Min Buy 1 EA

55gal
HDIIONBL55GAL
UPC 659627000797
Min Buy 1 EA





Liquid

Whether you are a backyard greenhouse hobbyist or a professional commercial plant grower, MotherPlant® Nutrients will help your mother plant, or stock plant, produce the most vigorous plant clones possible!

HDI MotherPlant® Nutrients Part A

Exact N-P-K ratios are calibrated to meet the nutritional requirements of the mother plant, without excess nitrates. Rich bio-organics are added to improve the uptake of nutrients and strengthen the plant's natural immunity to environmental stress resulting in strong, vibrant clones.



32oz

HDIMOTHERAQT

UPC 659627014046

Min Buy 12 EA

1gal

HDIMOTHERAGAL

UPC 659627014145

Min Buy 4 EA

2.5gal

HDIMOTHERA25GAL

UPC 659627014244

Min Buy 2 EA

5gal

HDIMOTHERA5GAL

UPC 659627000872

Min Buy 1 EA

55gal

HDIMOTHERA55GAL

UPC 659627000766

Min Buy 1 EA



HDI MotherPlant® Nutrients Part B

MotherPlant® Nutrients are specifically formulated for the nutritional requirements of mother plants using only the highest quality lab grade minerals with added bio-organics to strengthen the plant's natural immunity to environmental stress, in turn producing the most vigorous clones possible.



32oz

HDIMOTHERBQT

UPC 659627014053

Min Buy 12 EA

1gal

HDIMOTHERBGAL

UPC 659627014152

Min Buy 4 EA

2.5gal

HDIMOTHERB25GAL

UPC 659627014251

Min Buy 2 EA

5gal

HDIMOTHERB5GAL

UPC 659627000889

Min Buy 1 EA

55gal

HDIMOTHERB55GAL

UPC 659627000773

Min Buy 1 EA



HDI Ionic® Grow Plant Nutrient 3-1-5

Specifically formulated for the vegetative stage of growing plants, Ionic® Grow delivers the essential elements to the roots of a plant in a more precise manner than all previous hydroponic formulations. It is designed to maximize the potential for vigorous vegetative growth in growing plants and during the vegetative cycle of flowering plants. Ionic® Grow has a highly stable pH due to the unique reactive buffering incorporated into the quality controlled manufacturing process, reducing pH fluctuations in the reservoir.



32oz

HDIIONGRQT

UPC 659627000018

Min Buy 12 EA

1gal

HDIIONGRGAL

UPC 659627000025

Min Buy 4 EA

2.5gal

HDIIONGR25GAL

UPC 659627000032

Min Buy 2 EA

5gal

HDIIONGR5GAL

UPC 659627000049

Min Buy 1 EA

55gal

HDIIONGR55GAL

UPC 659627000780

Min Buy 1 EA



HDI Ionic® PK BOOST Plant Nutrient 0-5-6

Ionic® PK Boost is a plant nutrient supplement specifically formulated to be applied during the final few weeks before harvest of most fruiting and/or flowering crops. Ionic Boost provides the extra phosphorus and potassium that can lead to bumper yields. Ionic PK Boost is designed to work with Ionic® Bloom and Ionic® Bloom Hard water, but is also compatible with almost all liquid nutrients of the bloom variety.



32oz

HDIIONBOQT

UPC 659627000179

Min Buy 12 EA

1gal

HDIIONBOGAL

UPC 659627000186

Min Buy 4 EA

2.5gal

HDIIONBO25GAL

UPC 659627000193

Min Buy 2 EA

5gal

HDIIONBO5GAL

UPC 659627000209

Min Buy 1 EA

55gal

HDIIONBO55GAL

UPC 659627000803

Min Buy 1 EA



HDI Ionic® Grow for Soil Plant Nutrient 3-1-5

Ionic Grow for Soil contains the highest quality minerals and is powerfully enriched with naturally occurring plant acids that increase overall nutrient uptake and enhance growth and yields of virtually every plant.



32oz

HDIIONSOGRQT

UPC 659627000230

Min Buy 12 EA

1gal

HDIIONSOGRGAL

UPC 659627000247

Min Buy 4 EA

2.5gal

HDIIONSOGR25GAL

UPC 659627000339

Min Buy 2 EA

5gal

HDIIONSOGR5GAL

UPC 659627000346

Min Buy 1 EA

55gal

HDIIONSOGR55GAL

UPC 659627000834

Min Buy 1 EA





Propagation

HDI Clonex® Mist Root Promoter

For mother plants, clones to stimulate root development. Formulated to help enhance the health and vigor of tender young plants while promoting robust root development and elongation of root hairs.



100ml - Ready to Use

HDICLONIST100

UPC 502564491389

Min Buy 20 EA

300ml - Ready to Use

HDICLONIST300

UPC 502564491465

Min Buy 6 EA

750ml - Ready to Use

HDICLONIST750

UPC 811915020010

Min Buy 6 EA

1qt - Concentrate

HDICLONISTCONQT

UPC 811915020119

Min Buy 6 EA

1gal - Concentrate

HDICLONISTCONGAL

UPC 659627000940

Min Buy 1 EA



HDI Clonex® Clone Solution

A plant nutrient specifically formulated for rooted clones and seedlings. It contains a special blend of the highest quality minerals including Nitrogen, Phosphorus, Potassium, and Calcium plus other essential elements that all plants require for vigorous growth.



20ml

HDICCCPACKET

UPC 659627000513

Min Buy 18 EA

32oz

HDICCSQT

UPC 659627009004

Min Buy 12 EA

1gal

HDICCSGAL

UPC 659627009011

Min Buy 1 EA

2.5gal

HDICCS25GAL

UPC 659627009028

Min Buy 1 EA

5gal

HDICCS5GAL

UPC 659627009035

Min Buy 1 EA

55gal

HDICCS55GAL

UPC 659627000858

Min Buy 1 EA



HDI Clonex® Rooting Gel

Clonex® Rooting Gel is a high performance, water-based, rooting gel. It is a tenacious gel which will remain in contact around the stem, actually sealing the cut tissue and then supplying the hormones needed to promote root cell development.



15ml - Single Use Packets

HDICLOGELPK

UPC 659627002043

Min Buy 18 EA

100ml - Wide Mouth Bottle

HDICLOGEL100ML

UPC 659627002029

Min Buy 12 EA

250ml - Wide Mouth Bottle

HDICLOGEL250ML

UPC 659627002036

Min Buy 12 EA

16oz

HDICLOGELPT

UPC 659627002074

Min Buy 6 EA

32oz

HDICLOGELQT

UPC 659627002050

Min Buy 1 EA

1gal

HDICLOGELGAL

UPC 811915020164

Min Buy 1 EA



Liquid

Peters® STEM Fertilizer

Ready-to-mix liquid formulation. Goes from the jug to the tank in one easy step with no solubility issues. This fertilizer and broad-spectrum minor element product is ideal for "quick fixes" on ornamental plants and micronutrient deficient crops. It can also be applied as a remedial foliar spray on tropical foliage, flowering plants, cut flowers and orchids.



2.64gal (50/PL)

EVRE99068

UPC 848264002510

Min Buy 1 BT



Dry

Osmocote® Plus 15-9-12, 5-6 Month Fertilizer

A complete fertilizer solution that will continue to feed the plants after the sale. Works great on hanging baskets and potted plants grown in the greenhouse, as well as container-grown nursery plants, landscape containers and beds. Adding a controlled release fertilizer to baskets with high nutrient demands allows you to fertilize all other plants with a standard water-soluble program.



50lb (40/PL)

EVRE903226

UPC 032247903226

Min Buy 1 BG



Water Soluble

Peters® Professional 5-11-26 Hydroponic Special Fertilizer

Designed exclusively for hydroponic culture, this classic formula is ideal for most hydroponic crops, especially tomatoes, cucumbers, and lettuce. Effective for all water types. Buffered to help maintain correct working solution pH.



25lb (80/PL)

EVR99310

Min Buy 1 BG





Liquid

JH Biotech Biomin® Boron

Biomin® Boron contains boron for soil and/or foliar application. Completely bioavailable and non-phytotoxic to plants when applied in accordance to directions. Designed to prevent and correct boron deficiencies and to boost crops during critical or fast growing periods. May be applied with nitrogen fertilizers.



2.5gal

JH051001

Min Buy 1 EA

JH Biotech Biomin® Calcium

Biomin® Calcium contains chelated calcium designed for soil and foliar application. It is completely bioavailable and non-phytotoxic to plants when applied in accordance to directions. Designed to prevent and correct micronutrient deficiencies and to boost crops during critical or fast growing periods. May be applied with nitrogen fertilizer.



2.5gal

JH051005

Min Buy 1 EA



JH Biotech Biomin® Copper

Biomin® Copper contains chelated copper for soil and/or foliar application. Completely bioavailable and non-phytotoxic to plants when applied in accordance to directions. Designed to prevent and correct copper deficiencies and to boost crops during critical or fast growing periods. May be applied with nitrogen fertilizers.



2.5gal

JH051008

Min Buy 1 EA



JH Biotech Biomin® Iron

Biomin® Iron contains chelated iron for soil and/or foliar application. Completely bioavailable and non-phytotoxic to plants when applied in accordance to directions. Designed to prevent and correct iron deficiencies and to boost crops during critical or fast growing periods. May be applied with nitrogen fertilizers.



2.5gal

JH051010

Min Buy 1 EA



JH Biotech Biomin® Manganese

Biomin® Manganese contains nitrogen and chelated manganese for soil and/or foliar applications. It is completely bioavailable and nonphytotoxic to plants when applied in accordance to directions. Biomin® Manganese is designed to prevent and correct manganese deficiency and to boost crops during critical or fast growing periods. Biomin® Manganese may be applied with nitrogen fertilizers.



2.5gal

JH051012

Min Buy 1 EA



JH Biotech Biomin® Magnesium

Biomin® Magnesium contains chelated magnesium for soil and/or foliar application. Completely bioavailable and non-phytotoxic to plants when applied in accordance to directions. Designed to prevent and correct magnesium deficiencies and to boost crops during critical or fast growing periods. May be applied with nitrogen fertilizers.



2.5gal

JH051011

Min Buy 1 EA



JH Biotech Biomin® Molybdenum

Biomin® Molybdenum contains molybdenum for soil and/or foliar application. Completely bioavailable and non-phytotoxic to plants when applied in accordance to directions. Designed to prevent and correct molybdenum deficiencies and to boost crops during critical or fast growing periods. May be applied with nitrogen fertilizers.



2.5gal

JH051014

Min Buy 1 EA

JH Biotech Biomin® Zinc

Biomin® Zinc contains chelated zinc for soil and/or foliar application. Completely bioavailable and non-phytotoxic to plants when applied in accordance to directions. Designed to prevent and correct zinc deficiencies and to boost crops during critical or fast growing periods. May be applied with nitrogen fertilizers.



2.5gal

JH051021

Min Buy 1 EA



Water Soluble

MycoApply® Soluble MAXX

MycoApply Soluble Maxx is a suspendable powder mycorrhizal inoculum consisting of 9 species of endomycorrhizal fungi and 10 species of ectomycorrhizal fungi. Plus specially formulated amendments including kelp and humic acids, well-suited to a variety of soils, climates, and plants.



1lb

MAFMASOLMX10

Min Buy 1 BG

MycoApply® Injector Endo Organic

MycoApply® Injector Endo Organic is an OMRI-Listed concentrated suspendable powder that contains propagules of multiple species of arbuscular mycorrhizal fungi (AMF) on a soluble humic carrier. The arbuscular mycorrhizal fungi colonize the root systems of plants in a symbiotic manner, expand out beyond the plant roots or rhizosphere region of the soil surrounding the plant roots to acquire nutrients and water, and actively deliver these resources to the plant's vascular system. Arbuscular mycorrhizal fungi form symbiotic associations with roots of most horticulturally important crops.



100g - 10/CS

MASAS1011604455

Min Buy 1 EA

Liquid

MycoApply® EndoThrive™

MycoApply® EndoThrive™ contains propagules of multiple species of endomycorrhizae, or arbuscular mycorrhizal fungi (AMF) on a non-aqueous liquid carrier. These AMF colonize the root systems of plants in a symbiotic manner, expand out beyond the plant roots or rhizosphere region of the soil surrounding the plant roots to acquire nutrients and water, and actively deliver these resources to the plant's vascular system. MycoApply® EndoThrive™ is ideal for all horticulture and turf applications, as it is easy to dilute and apply via any method that fits a grower's production protocol.



16oz - 8/CS

MASAS1011704016

Min Buy 1 EA

Dry

MycoApply® Endo

MycoApply Endo is a granular material containing mycorrhizal propagules, which colonize roots and extend into the surrounding soil forming an essential link between plants and soil resources. Increasing the rooting area allows improved access to water and nutrients, promoting plant quality and crop performance.



40lb

MAFMAEN40

Min Buy 1 BG



MycoApply® Endo / Ecto

MycoApply Endo/Ecto is a granular mycorrhizal inoculum consisting of 4 species of endomycorrhizal fungi and 7 species of ectomycorrhizal fungi. These beneficial fungi greatly increase the effective rooting area of plants, thereby enhancing plant growth, vigor, and tolerance of environmental extremes.



40lb

MAFMAENEC40

Min Buy 1 BG



MycoApply® Ultrafine Endo

MycoApply Ultrafine Endo is a suspendable powder mycorrhizal inoculum consisting of 4 species of endomycorrhizal fungi. These beneficial fungi greatly increase the effective rooting area of plants, thereby enhancing plant growth, vigor and tolerance of environmental extremes. OMRI Listed. Bullet Points: 4 species Endomycorrhizae, Glomus intraradices, Glomus mosseae, Glomus aggregatum, Glomus etunicatum, 130,000 Endomycorrhizal Propagules per lb.



1lb

MAAS1000304455

Min Buy 10 EA

20lb

MAFMAUEN20

Min Buy 1 BG



MycoApply® Ultrafine Endo / Ecto

MycoApply Ultrafine Endo/Ecto is a suspendable powder mycorrhizal inoculum consisting of 4 species of endomycorrhizal fungi and 7 species of ectomycorrhizal fungi. These beneficial fungi greatly increase the effective rooting area of plants, thereby enhancing plant growth, vigor and tolerance of environmental extremes. OMRI Listed.



1lb

MAAS1050204455

Min Buy 1 EA

20lb

MAFMAUENEC20

Min Buy 1 BG





Water Soluble

Magnesium Nitrate Magnific 11-0-0

A soluble fertilizer that provides nitrogen and magnesium.



50Lb (42/PL)
PLNTX10267
 Min Buy 1 BG

Magnesium Sulfate (Epsom Salt)

Epsom salts is a source of magnesium for plant nutrition.



50Lb (49/PL)
PLNTX11029
 Min Buy 1 BG



Mono-Potassium Phosphate 0-52-34

Often used as a nutrient source in greenhouses while minimizing the escape of ammonia by keeping the pH at a relatively low level.



55lb
PLNTX10279
 Min Buy 1 BG



Potassium Bicarbonate

For use in raising or stabilizing the pH of hydroponic solutions.



55lb (44/PL)
PLNTX10404
 Min Buy 1 BG



Potassium Sulphate 0-0-52

A soluble fertilizer providing sulfur and potassium



55lb (42/PL)
PLNTX10410
 Min Buy 1 BG



Plant-Prod MJ Bloom 10-30-20 Fertilizer

Plant-Prod MJ Bloom 10-30-20 is an essential formulation during weeks 5-10 for optimal bud formation and fill. This high phosphorous, moderate potassium formulation encourages full bud set and improves bud filling. The added magnesium ensures no signs of deficiency. Bloom also contains an enhanced micronutrient package with additional EDDHA iron to ensure efficient uptake at a wide range of pH levels.



6 x 2kg
PLNTX12320
 Min Buy 1 CS



25lb (80/PL)
PLNTX12206
 Min Buy 1 EA

Plant-Prod MJ Boost 15-30-15 Fertilizer

Plant-Prod MJ Boost 15-30-15 is a high phosphorus formulation that supplies the necessary phosphorus for transplants and bud sizing. When plants are of a sufficient level of maturity or when buds are pea sized, feeding with 15-30-15 provides a boost of phosphorus to promote vigorous bud setting and sizing. Feed during Week 1 to establish a healthy root system, and during Week 4 to boost bud formation.



6 x 2kg
PLNTX12321
 Min Buy 1 CS



25lb (80/PL)
PLNTX12278
 Min Buy 1 EA

Plant-Prod MJ Finisher 4-31-37 Fertilizer

Plant-Prod MJ Finisher 4-31-37 is a finishing formulation with elevated phosphorus and potassium to encourage fullness and density of buds. During these last few weeks of production, this elevated potassium supports plant turgidity and disease resistance, while the phosphorus optimizes photosynthesis. The added nitrogen ensures no signs of deficiency.



6 x 2kg
PLNTX12323
 Min Buy 1 CS



25lb, 80/pl
PLNTX12280
 Min Buy 1 EA



Water Soluble

Plant-Prod MJ 15-0-14 Cal Kick

Plant-Prod MJ Cal Kick is a high calcium formulation that should be used as the main calcium source throughout the production cycle when levels in water source are not adequate. Calcium is vital to plant rigidity and bud formation.



25lb (80/PL)
PLNTX12305
 Min Buy 1 EA



Plantex Solutions® 17-5-17 Complete Fertilizer

The convenience of an all-in-one nutritional program, in one tank. This balanced formulation has high nitrate, complete calcium and magnesium along side an enhanced micronutrient package, and little impact on media pH.



25lb
PLNTX10132
 Min Buy 1 BG



Plant-Prod MJ Spike (CaMg) Fertilizer

Plant-Prod MJ Spike (CaMg) has been specifically formulated to meet the high demands of plants throughout the entire production cycle. This fully chelated formulation is an ideal supplemental feeding of calcium and magnesium. Use should be limited to 2 times per week at supplemental rates.



12 x 350g
PLNTX12389
 Min Buy 1 CS



25lb (80/PL)
PLNTX12310
 UPC
 Min Buy 1 EA

Plant-Prod MJ Grow 12-8-26 Fertilizer

This ideal ratio of nitrogen, phosphorus and potassium promotes optimal growth to ensure a sufficient plant structure to support target yields. The added magnesium ensures no signs of deficiency. Grow contains an enhanced micronutrient package with additional EDDHA iron to ensure efficient uptake at a wide range of pH levels. Feed during Weeks 2 and 3 for steady growth.



6 x 2kg
PLNTX12319
 UPC
 Min Buy 1 CS



25lb (80/PL)
PLNTX12279
 Min Buy 1 EA

Feed Clean, Grow Green.™

Plant-Prod MJ™ Program Schedule by Week

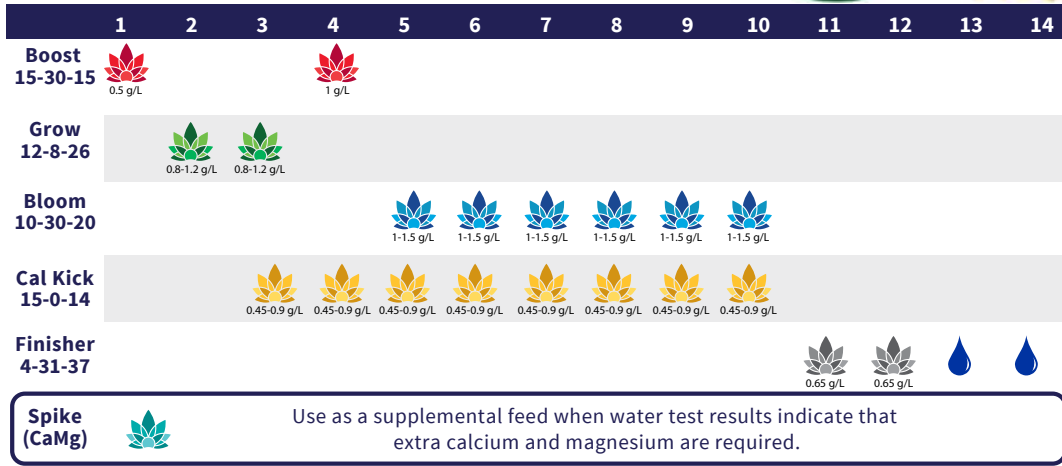

O H R S T R O M ' S
maxicrop

Liquid

Maxicrop Liquid Seaweed Plus Iron 2% 0-0-1

Maxicrop Liquid Seaweed Plus Iron is ready to dilute in water, has a guaranteed analysis of 0-0-1 and is excellent for soaking seeds and bulbs, treating seedlings, cuttings, bare root trees and shrubs before and after transplant. Maxicrop Liquid Seaweed Plus Iron can be used as a foliar feed indoor and outdoor, on a variety of acid loving plants and in hydroponic systems.



32oz Bottle

MAX2001
UPC 755361011041
Min Buy 12 EA

1gal Bottle

MAX2002
UPC 755361011034
Min Buy 6 EA

2.5gal

MAX2003
UPC 755361011058
Min Buy 2 EA



Dry

Maxicrop Kelp Meal 1-0-2

Maxicrop 1-0-2 Kelp Meal is a Norwegian Kelp, one of the richest known sources of minerals, vitamins and amino acids. When used as a soil conditioner, Maxicrop Kelp Meal will improve deficiencies, thereby adding to the nutrition of vegetables from the garden.



5lb Bag

MAX5000
UPC 755361030011
Min Buy 6 EA

55lb Bag

MAX5055
Min Buy 1 EA



Maxicrop Liquid Fish 3-1-1

Maxicrop Liquid Fish is made from fresh Menhaden fish and has a guaranteed analysis of 3-1-1. It is a fertilizer concentrate full of nutrients that can be used on all types of indoor and outdoor plants. The liquid is ready to dilute in water. Maxicrop Liquid Fish can be used as a foliar feed indoors or out or as a soil drench feed. Great for use on flowers, trees, lawns, fruits, vegetables, etc.



32oz Bottle

MAX3001
UPC 755361040010
Min Buy 12 EA

1gal Bottle

MAX3002
UPC 755361040034
Min Buy 6 EA

2.5gal

MAX3003
UPC 755361040058
Min Buy 2 EA



Water Soluble

Maxicrop Soluble Seaweed Powder 0-0-17

Maxicrop Soluble Seaweed Powder is a great choice for those who want to feed their plants naturally occurring minerals, vitamins, and enzymes. Maxicrop Soluble Seaweed Powder is extracted from Norwegian Ascophyllum nodosum seaweed. Maxicrop Soluble Seaweed Powder has a guaranteed analysis of 0-0-17 and is listed by the Organic Materials Review Institute (OMRI) for use in organic certified production. Great for use on flowers, shrubs, trees, berries, vegetables, fruit, root crops, etc.



10.7oz Bottle

MAX1025
UPC 755361020012
Min Buy 12 EA

27oz Bottle

MAX1026
UPC 755361021002
Min Buy 6 EA

5lb

MAX1050
UPC 755361022993
Min Buy 6 EA

10lb

MAX1027
UPC 755361020432
Min Buy 1 EA

22lb

MAX1028
UPC 755361023990
Min Buy 1 EA

44lb

MAX1030
UPC 755361025116
Min Buy 1 EA



Maxicrop Liquid Seaweed 0-0-1

Maxicrop Liquid Seaweed is ready to dilute in water, has a guaranteed analysis of 0-0-1 and is excellent for soaking seeds and bulbs, treating seedlings, cuttings, bare root trees and shrubs before and after transplant. Maxicrop Liquid Seaweed can be used as a foliar feed indoors or out and can be used on a variety of plants.



32oz Bottle

MAX1001
UPC 755361010051
Min Buy 12 EA

1gal Bottle

MAX1002
UPC 755361010037
Min Buy 6 EA

2.5gal Bottle

MAX1003
UPC 755361010044
Min Buy 2 EA





Dry

Sustane® 4-6-4 Flower Vegetable Plant Food OMRI®

All natural and organic, compost-based fertilizer is high in organic content and contains all 17 essential plant nutrients. It builds soil structure & promotes microbial diversity and is ideal for general soil preparation of vegetable and flower beds.



5lb
SNF80201105
 UPC 031417000437
 Min Buy 8 EA

20lb (100/PL)
SNF80201121
 UPC 031417000468
 Min Buy 1 EA

50lb (40/PL)
SNF30201111
 Min Buy 1 EA

Sustane® 8-2-4 Lawn Landscape Plant Food OMRI®

Provides 6 - 12 weeks of nitrogen in the organic slow release form. Sustane replenishes the soil with a rich supply of humus (stabilized organic matter) and all of the essential nutrients required for quality growth. Also provides a combination of plant nutrients and organic substances derived from biologically stable compost plus natural sulfate of potash and feather meal.



5lb
SNF80551105
 UPC 31417000482
 Min Buy 8 EA

20lb (100/PL)
SNF80551121
 UPC 31417000475
 Min Buy 1 EA

50lb (40/PL)
SNF30551111
 Min Buy 1 BG



Water Soluble

Sustane® Flourish WDF Fertilizer 8-2-4

Sustane Flourish 8-2-4 WDF is an all-in-one input designed for manual fertigation. Sustane Flourish WDF provides powdered organic nutrients and biostimulants and is well suited for the production of diverse plants, indoors and outdoors.



1lb
SNF70502001
 UPC 031417002158
 Min Buy 12 BG

3lb
SNF70502003
 UPC 031417002165
 Min Buy 12 BG

Sustane® Hi-N® WDF Fertilizer 12-0-1

A high analysis, water dispersible, nitrogen fertilizer. Specifically formulated to promote rapid and durable greening and plant growth. Efficiently delivers a unique blend of soluble organic nitrogen sources to support plant growth. It can be used on diverse plants produced in a wide variety of growing systems.



1lb
SNF70552001
 Min Buy 12 BG

3lb
SNF70552003
 Min Buy 12 BG

Other

Sustane® Bolster® MycoBio™

Bolster® MycoBio™ is a blend of endo mycorrhizae species and beneficial bacteria, with humic acid and compost to support the proliferation of soil microorganisms. Bolster® MycoBio™ is used for inoculating soils and growing media with beneficial microbiology for improved nutrient cycling and to amend soil to improve seedling success and promote vigorous plant establishment.



1lb (12/cs) Case Only
SNF60606061
 Min Buy 1 EA

6lb (4/cs) Case Only
SNF60606065
 Min Buy 1 EA

40lb (40/PL)
SNF60606060
 Min Buy 1 EA



Dry

Neptune's Harvest® Crab & Lobster Shell Organic Fertilizer 5-3-0

A natural source of nitrogen, phosphorus, calcium and magnesium. When integrated in your soil it encourages growth of chitin-eating bacteria, which helps to control ants, grubs, fungus and root nematodes. Keeps slugs and snails off when placed around plants. Also helps choke out weeds and even keeps moles, mice, etc from digging up bulbs and root vegetables.



4lb Bag
NEPCS604

UPC 081435506046

Min Buy 6 EA

12lb Pail
NEPCS612

UPC 081435504103

Min Buy 4 EA



Neptune's Harvest® Kelp Meal Multi-Purpose Plant Food 1-0-2

Adds organic matter to your soil and helps it retain moisture. Enhances healthy root growth. Can be incorporated into potting soils, seed and transplant beds, as well as composting material. Kelp Meal contains minerals, carbohydrates and amino acids. OMRI® listed.



4lb Bag
NEPKM604

UPC 081435406049

Min Buy 6 EA



Liquid

Neptune's Harvest® Tomato & Veg Fertilizer 2-4-2

This is a perfect complete fertilizer for your tomatoes, vegetables and more. Made from fresh fish, seaweed, molasses, yucca extract and humic acids, this formula was uniquely designed for plants with intense growth or "vegging" stages. Growers using "Tomato & Veg" have seen increased stalk/stem mass resulting in higher yields. In addition, Tomato & Veg provides necessary nutrients to keep your plants vigorous with strong root zones and lush foliage, increasing its tolerance to various diseases, temperature and drought.



36oz Concentrate
NEPTV136

UPC 081435736122

Min Buy 12 EA

1gal Concentrate
NEPTV191

UPC 081435740099

Min Buy 4 EA



Liquid

Neptune's Harvest® Fish & Seaweed Fertilizer 2-3-1

A perfect blend of fish hydrolysate and seaweed, ensuring a complete fertilization program. Flowers and foliage will be stronger and more colorful. Blooms will be more plentiful, fragrant and longer lasting. Recommended for vegetables, berries and fruit trees to build the natural sugars for better tasting crops from your garden. OMRI® listed.



36oz Concentrate
NEPFS136

UPC 081435236127

Min Buy 12 EA

142oz Concentrate
NEPFS191

UPC 081435240094

Min Buy 4 EA

5gal Concentrate
NEPFS150

UPC 081435250451

Min Buy 1 EA



Neptune's Harvest® Fish Fertilizer 2-4-1

An organic fertilizer made from fresh North Atlantic fish. Contains all the micro and macro nutrients naturally found in fish. The nitrogen and other nutrients are readily available for plant consumption. Retains the fish proteins and oils and has no unpleasant odor. OMRI® listed.



18oz Concentrate
NEPHF118

UPC 081435018129

Min Buy 12 EA

36oz Concentrate
NEPHF136

UPC 081435036123

Min Buy 12 EA

1gal Concentrate
NEPHF191

UPC 081435040090

Min Buy 4 EA

5gal Concentrate
NEPHF150

UPC 081435050457

Min Buy 1 EA



Neptune's Harvest® Seaweed Plant Food 0-0-1

Neptune's Harvest Seaweed Plant Food is made from Ascophyllum Nodosum that grows along the cold North Atlantic ocean floor. Recommended for use as an addition to a regular program of Neptune's Harvest Fish Fertilizer. Use this plant food on all your plants in alternate feedings. 1oz makes 1gal of solution. OMRI® listed.



16oz Concentrate
NEPSW118

UPC 081435118126

Min Buy 12 EA

32oz Concentrate
NEPSW136

UPC 081435136120

Min Buy 12 EA

1gal Concentrate
NEPSW191

UPC 081435140097

Min Buy 4 EA





Propagation

Olivia's Cloning Solution®

Olivia's Solution feeds new cuttings as they root and helps to reduce transplant shock.



1qt
OCGOCS1

UPC 860003013854
Min Buy 24 EA

1gal
OCGOCS4

UPC 860003013861
Min Buy 4 EA



Olivia's Cloning Gel®

A professional strength, easy/ready to use propagation gel. Just cut, clip and grow! Stimulates root development for all types of plants.



2oz
OCG1

UPC 860003013821
Min Buy 24 EA

4oz
OCG4

UPC 860003013885
Min Buy 24 EA

8oz
OCG8

UPC 860003013892
Min Buy 12 EA



Other

Plant Perfect ExHale 365

ExHale 365 is a self-activated version of the Original CO2 Bag. The 365 will provide a 128cuft space with CO2 for 9 months of which 6 months are peak production time.



6 x 9 x 8 Brown/White Media
EXEGCF365E

UPC 045635863491
Min Buy 8 EA



Plant Perfect ExHale Co2

The power of ExHale lies in the mycelial mass inside the vented cultivator.



6 x 9 x 8 Brown/White Media
EXEGCFEXC02B

UPC 793573065933
Min Buy 8 EA



Plant Perfect ExHale XL

The XL is for medium to large grow spaces. This will provide a 288cu ft space with Co2 for 6 months.



8 x 7 x 11 Brown/White Media
EXEGCFXLEXB

UPC 639302577226
Min Buy 4 EA



Dry

Superfine Dolomitic Limestone

Superfine is a very fine grind of lime as well as a fast acting lime. It can be applied at any time of the year and be used on new lawns, established lawns, in gardens and media. It neutralizes soil acids and raises PH.



50lb (48/PL)
WAUKM03890

UPC
Min Buy 1 BG





Liquid

Nectar For The Gods Athena's Aminos 0.5-0-0

Athena's Aminos provides a readily available amino acid source of nitrogen to optimize protein production and allow for maximum growth rates. By adding an amino acid source of nitrogen, you enable your plants to build proteins as quickly as they are able. When using Athena's Aminos, you can expect to see faster, healthier growth, resulting in bigger, more vigorous plants.



- 1qt**
NFGAAQ
UPC 812863010139
Min Buy 1 EA
- 1gal**
NFGAAG
UPC 812863010146
Min Buy 4 EA
- 2.5gal**
NFGAA2
UPC 812863010153
Min Buy 2 EA
- 5gal**
NFGAA5
UPC 812863010160
Min Buy 1 EA
- 55gal**
NFGAA55
Min Buy 1 EA



Nectar For The Gods Mega Morpheus Guano Tea 0-2-0

Mega Morpheus is a fully digested source of readily available natural phosphate, and the only guano tea on the market today that is free of grit and sand. Our unique process completely filters out grit and sand, offering a consistency suitable for soil, soilless, and hydroponic growing mediums. Nutrients in Mega Morpheus are made totally available through digestion and chelation, increasing nutrient delivery and uptake. When using Mega Morpheus, you can expect an increase in photosynthesis, vigor, and health, as well as flower size and flavor.



- 1qt**
NFGMMORQ
UPC 812863010238
Min Buy 1 EA
- 1gal**
NFGMMORG
UPC 812863010245
Min Buy 4 EA
- 2.5gal**
NFGMMOR2
UPC 812863010252
Min Buy 2 EA
- 5gal**
NFGMMOR5
UPC 812863010269
Min Buy 1 EA
- 55gal**
NFGMMOR55
Min Buy 1 EA



Nectar For The Gods Demeter's Destiny Liquid Calcium 0-0.5-0

This special blend offers microbes and root systems balanced forms of calcium, which help to carry all nutrients into the plant except for nitrogen and potassium, including magnesium. Most fertilizers deliver nutrients via a nitrate. Calcium delivery means nutrients are more accessible to your plant and less likely to be locked out.



- 1qt**
NFGDDQ
UPC 812863010337
Min Buy 1 EA
- 1gal**
NFGDDG
UPC 812863010344
Min Buy 4 EA
- 2.5gal**
NFGDD2
UPC 812863010351
Min Buy 2 EA
- 5gal**
NFGDD5
UPC 812863010368
Min Buy 1 EA
- 55gal**
NFGDD55
Min Buy 1 EA



Nectar For the Gods Gaia Mania Supplement 1-5-1

Gaia Mania is a careful blend of organic materials, enzymatically processed to extract only proteins and humates. This digestion process is the beginning step in the absorption of vitamins, acids, and minerals by the plant. Gaia Mania has the ability to feed plants immediately and is also designed to promote microbial populations in your medium, offering greater protection to plants' root systems.



- 1qt**
NFGGMQ
UPC 812863010092
Min Buy 1 EA
- 1gal**
NFGGMG
UPC 812863010085
Min Buy 4 EA
- 2.5gal**
NFGGM2
UPC 812863010108
Min Buy 2 EA
- 5gal**
NFGGM5
UPC 812863010115
Min Buy 1 EA
- 55gal**
NFGGM55
Min Buy 1 EA



Nectar For The Gods The Kraken Crab & Shrimp 0-4-0

The Kraken is a digested crab and shrimp shell product developed to aid in strengthening plant stem and flower sites. Stronger plants mean less staking and greater plant health.



- 1qt**
NFGTKQ
UPC 812863010122
Min Buy 1 EA
- 1gal**
NFGTKG
UPC 812863010627
Min Buy 4 EA
- 2.5gal**
NFGTK2
UPC 812863010320
Min Buy 2 EA
- 5gal**
NFGTK5
UPC 812863010078
Min Buy 1 EA
- 55gal**
NFGTK55
Min Buy 1 EA





Liquid

Nectar For The Gods Herculean Harvest Liquid Bone Meal 0-6-0

Herculean Harvest increases the availability of phosphorus to your plants and soil, producing a wide range of benefits to plant health, structure, and flavor, contributing to a vigorous soil food web and improving the accessibility of nutrients.



1qt NFGHHARQ
UPC 812863010283
Min Buy 1 EA

5gal NFGHHAR5
UPC 812863010313
Min Buy 1 EA

1gal NFGHHARG
UPC 812863010290
Min Buy 4 EA

55gal NFGHHAR55
Min Buy 1 EA

2.5gal NFGHHAR2
UPC 812863010306
Min Buy 2 EA



Nectar For The Gods Bloom Khaos Foliar Spray 0-0-0.5

When using Bloom Khaos as a foliar feed, one should notice more flower sites, larger, denser flowers, and superior color, flavor, and aroma. Bloom Khaos improves plant health and vigor while reducing stress at crucial times of the plants' life cycle, such as transplanting, flower transition, and prior to taking cuttings. Bloom Khaos works best if used daily as a foliar spray in the early stages of growth and up to a few weeks into flowering.



1qt NFGBKQ
UPC 812863010634
Min Buy 1 EA

5gal NFGBK5
UPC 812863010665
Min Buy 1 EA

1gal NFGBKG
UPC 812863010641
Min Buy 4 EA

55 1gal NFGBK55
Min Buy 1 EA

2.5gal NFGBK2
UPC 812863010658
Min Buy 2 EA



Nectar For the Gods Medusa's Magic Soil Nutrient 2-5-2

To brew Medusa's Magic, proteins and enzymes are gently extracted from materials and then suspended in a worm casting tea. Nitrogen in Medusa's Magic is derived from a protein which will result in a healthier, more natural growth pattern in your plants. The healthier the plant, the more efficient the plant's natural response to produce its own defense mechanisms against pests and disease.



1qt NFGMMAGQ
UPC 812863010023
Min Buy 1 EA

5gal NFGMMAG5
UPC 812863010061
Min Buy 1 EA

1gal NFGMMAGG
UPC 812863010030
Min Buy 4 EA

55gal NFGMMAG55
Min Buy 1 EA

2.5gal Concentrate NFGMMAG2
UPC 812863010047
Min Buy 2 EA



Nectar For The Gods Hades Down 0-1-0

Hades Down is a pH adjusting liquid used to lower the pH of your nutrient solution. When mixing fertilizers in a reservoir, Hades Down will help prevent nutrient solution fall out.



1qt NFGHDQ
UPC 812863010689
Min Buy 1 EA

5gal NFGHD5
UPC 812863010719
Min Buy 1 EA

1gal NFGHDG
UPC 812863010696
Min Buy 4 EA

55gal NFGHD55
Min Buy 1 EA

2.5gal NFGHD2
UPC 812863010702
Min Buy 2 EA



Nectar For The Gods Hygeia Hydration Yucca Extract

Rich in saponins, Yucca acts as a wetting agent to aid in root penetration for maximum nutrient uptake. Hygeia's Hydration can be used for those pesky soils that dry out and will not rehydrate with regular watering.



1qt NFGHHYDQ
UPC 812863010481
Min Buy 1 EA

5gal NFGHHYD5
UPC 812863010511
Min Buy 1 EA

1gal NFGHHYDG
UPC 812863010498
Min Buy 4 EA

55gal NFGHHYD55
Min Buy 1 EA

2.5gal NFGHHYD2
UPC 812863010504
Min Buy 2 EA





Liquid

Nectar For The Gods Olympus Up

Olympus Up is the Nectar for the Gods pH up product. By using liquid calcium as a pH adjusting component, you will add more calcium to your plants' cell structure, promoting cell wall integrity. Residual Olympus Up in the soil will increase aeration, promote microbial activity by offering a food source for the soil biota, and contribute to nutrient delivery. We recommend using Olympus Up with Herculean Harvest to form an amazing calcium food source for soil microbes.



1qt
NFGOUQ

UPC 812863010580
Min Buy 1 EA

1gal
NFGOUG

UPC 812863010597
Min Buy 4 EA

2.5gal
NFGOU2

UPC 812863010610
Min Buy 2 EA

5gal
NFGOU5

UPC 812863010603
Min Buy 1 EA

55gal
NFGOU55

Min Buy 1 EA



Nectar For The Gods Pegasus Potion Feather Tea 1-2-0

Extraction through enzyme hydrolysis makes Pegasus Potion more biochemically viable, preserving amino acid integrity by breaking proteins at specific sites. This is the first pure-nitrogen product on the market that is not a salt based mineral or urea-based nitrogen. Incredibly gentle on plants' foliage and root zone, Pegasus Potion provides a readily available amino acid nitrogen source. Pegasus Potion can be used as an extremely effective foliar spray as well as a root drench to promote greening and vegetative growth. A little warning to all who are thinking about using Pegasus Potion: IT SMELLS REALLY BAD. We have done everything in our power to quell the stench, and nothing we have tried will mask the smell. Sorry.



1qt
NFGPPQ

UPC 812863010535
Min Buy 1 EA

1gal
NFGPPG

UPC 812863010542
Min Buy 4 EA

2.5gal
NFGPP2

UPC 812863010559
Min Buy 2 EA

5gal
NFGPP5

UPC 812863010566
Min Buy 1 EA

55gal
NFGPP55

Min Buy 1 EA



Nectar For The Gods Persephone's Palate

Persephone's Palate is our answer to the use of molasses in a feeding regimen. The calcium in the lignin acts as a microbial food while the lignin sulphonate acts as a chelating agent, (large, organic molecules that are used to envelop highly-reactive trace metal ions). The purpose of chelates is to incorporate metal ions like magnesium, boron, and zinc into a soluble but bound form that is capable of supplying nutrients to the plants. As the chelate breaks down, the metal ion micronutrients are slowly released into the soil in a bioavailable form that may then be taken up by the plant.



1qt
NFGPPALQ

UPC 812863010771
Min Buy 1 EA

1gal
NFGPPALG

UPC 812863010788
Min Buy 4 EA

2.5gal
NFGPPAL2

UPC 812863010795
Min Buy 2 EA

5gal
NFGPPALS

UPC 812863010801
Min Buy 1 EA

55gal
NFGPPALS5

Min Buy 1 EA



Nectar For The Gods Poseidonzime Foliar Spray 0-0-0.5

Poseidonzime is a liquefied seaweed product providing soluble potassium. An excellent natural plant growth promoter, Poseidonzime reduces plant stress while increasing flower clusters and overall vigor in the plants' reproduction.



1qt
NFGPQ

UPC 812863010436
Min Buy 1 EA

1gal
NFGPG

UPC 812863010443
Min Buy 4 EA

2.5gal
NFGP2

UPC 812863010450
Min Buy 2 EA

5gal
NFGP5

UPC 812863010467
Min Buy 1 EA

55gal
NFGP55

Min Buy 1 EA



Nectar for the Gods Circe's Serum

Circe's Serum is an extremely soluble and available liquid bone meal source derived from pig bones. Circe increases the availability of phosphorus to your plants and soil, producing a wide range of benefits to plant health, structure, and flavor, contributing to a vigorous soil food web, and improving the accessibility of nutrients. Thinner and more soluble than Herculean Harvest, Circe offers another tool to help push and feed your plants and soil more aggressively.



32oz
NFGCSQ

UPC 812863011679
Min Buy 12 EA





Liquid

Nectar For The Gods Triton's Trawl Fishbone Meal 0.5-4-0

For those gardeners who want the benefit of a liquid bonemeal but have issues with the farming practices of livestock, here is an alternative for them. Rich in calcium from cartilage, Triton is designed to deliver flavor, aroma and color to the finished product. It can be used alone or to enhance the effects of Herculean Harvest.



1qt
NFGTTQ
UPC 812863010733
Min Buy 1 EA

1gal
NFGTTG
UPC 812863010740
Min Buy 4 EA

2.5gal
NFGTT2
UPC 812863010757
Min Buy 2 EA

5gal
NFGTT5
UPC 812863010764
Min Buy 1 EA

55gal
NFGTT55
Min Buy 1 EA



Liquid

Nectar For The Gods Aphrodite's Extraction Carbon 0-1-0

Aphrodite's Extraction provides a rich blend of sucrose, fructose, and phosphate to promote a thriving microbial population and strong, healthy plant growth. In addition to calcium, microbes need carbon in order to manufacture complex proteins for normal growth and reproduction: low carbon equals low microbial activity.



1qt
NFGAEQ
UPC 812863010382
Min Buy 1 EA

1gal
NFGAEG
UPC 812863010399
Min Buy 4 EA

2.5gal
NFGAE2
UPC 812863010405
Min Buy 2 EA

5gal
NFGAE5
UPC 812863010412
Min Buy 1 EA

55gal
NFGAE55
Min Buy 1 EA



Nectar For The Gods Zeus Juice Growth Enhancer

Zeus Juice represents the god of all plant nutrition, containing a full complement of compounds that are not generally found in The Industries' plant foods or supplements. These unique compounds are 100% water soluble and are absorbed immediately, acting as a catalyst to produce accelerated growth and nutrient uptake. With increased metabolic rates, Zeus Juice offers optimal nutrient availability, healthy plant growth, healthy prolific rooting and protection from transplant shock.



1qt
NFGZJQ
UPC 812863010184
Min Buy 1 EA

1gal
NFGZJG
UPC 812863010191
Min Buy 4 EA

2.5gal
NFGZJ2
UPC 812863010207
Min Buy 2 EA

5gal
NFGZJ5
UPC 812863010214
Min Buy 1 EA

55gal
NFGZJ55
Min Buy 1 EA



Dry

Nectar For The Gods One Shot 3-10-0

One Shot is a prilled natural fertilizer designed to feed your plants for up to six months depending on application.



4lb
NFGOS4
UPC 812863010276
Min Buy 10 EA

12lb
NFGOS12
UPC 812863010375
Min Buy 3 EA

25lb
NFGOS25
UPC 812863010672
Min Buy 1 EA

50lb
NFGOS50
UPC 812863010528
Min Buy 1 EA



Nectar for the Gods Chimera

Chimera is a limestone, calcium carbonate bloom additive for growers who source their water from reverse osmosis, distilled water, or rain water. These water sources diminish calcium carbonate in potting soils during a natural pH rebalancing reaction, creating availability issues in the soil due to an undesirable pH environment. Adding Chimera as a top dress in the early flowering stages will help build the soil's calcium availability and pH back into an ideal range so that the plants may thrive in the flowering stages. With the addition of finely ground porcine meal, Chimera makes a wonderful baseline for flowering plants. Ingredients: Limestone, porcine bone meal, bovine bone meal, dolomite, calcium lignosulfonate, and molasses.



4lb
NFGCHI4
UPC 812863012393
Min Buy 10 EA



PLANT REVOLUTION

Dry

Great White® Granular 1®

Great White® Granular 1® is the most affordable organic, mycorrhizal product in the marketplace. The single organic strain keeps the cost down Well-suited for use in vegetable, fruit and flower gardens. Adds beneficial microorganisms to the root zone to enhance plant vigor. OMRI listed.



4oz
PLSFGGRWH14OZ
UPC 689319030016
Min Buy 24 EA



2.2lb
PLSFGGRWH122LB
UPC 689319030023
Min Buy 12 EA

20lb
PLSFGGRWH120LBS
UPC 689319030047
Min Buy 1 EA

Plant Success Organics Granular™ 3-1-2

Plant Success Organics Granular promotes quick plant establishment. Contains mycorrhizae, bacteria, trichoderma and an all-purpose fertilizer. Microbes combine symbiotically with organic plant food to enhance plant and root growth. Well-suited to a variety of soils, climates and plants. Granular is easily applied to new plantings by sprinkling into a planting hole or mixing in potting soil. Provides an excellent microbe food to establish plants and beneficial organisms.



1oz
PLSFGPSOGRAN1OZ
UPC 689319013101
Min Buy 10 EA

5lb
PLSFGPSOGRAN5LB
UPC 689319013170
Min Buy 1 EA



1lb
PLSFGPSOGRAN16OZ
UPC 689319013125
Min Buy 12 EA

25lb
PLSFGPSOGRAN25LB
UPC 689319013194
Min Buy 1 EA

4oz
PLSFGPSOGRAN4OZ
UPC 689319013118
Min Buy 12 EA



Liquid

Myco Chum® Premium Microbe Food

Myco Chum 1-0-3 is a premium, organic microbial food containing a blend of molasses, fish hydrolysate, liquid kelp, humic acids and nutrients. A super charger for your microbes and sweetener for your fruits. Use Myco Chum from start to finish to optimize results.



16oz
PLSFGMYCH16OZ
UPC 689319015006
Min Buy 9 EA

1gal
PLSFGMYCH1G
UPC 689319015020
Min Buy 2 EA

32oz
PLSFGMYCH32OZ
UPC 689319015013
Min Buy 6 EA

5gal
PLSFGMYCH5G
UPC 689319015037
Min Buy 1 EA



Plant Success Orca

Premium Liquid Mycorrhizae with Beneficial Bacteria. Orca is a highly concentrated LIQUID mycorrhizal and beneficial bacteria product. It brings together 4 highly effective endo mycorrhizal species with 14 super effective bacteria strains. This all-in-one inoculant is all you need when it comes to beneficials. A powerful inoculant that is clean, easy to apply, and effective.



100ml
PLSFGORCAIN100ML
UPC 689319014007
Min Buy 12 EA

32oz
PLSFGORCAIN32OZ
UPC 689319014023
Min Buy 6 EA

16oz
PLSFGORCAIN16OZ
UPC 689319014016
Min Buy 9 EA

1gal
PLSFGORCAIN1GL
UPC 689319014030
Min Buy 2 EA



Water Soluble

Plant Success Organics Soluble™ 0.5-0.1-7

Plant Success Organics Soluble™ enhances established plants with beneficial soil microbes. Contains mycorrhizae, bacteria and trichoderma. Easily watered in and instantly establishes beneficial soil microbes as well as enhances plant and root growth. Well-suited to a variety of soils, climates and plants. Easily applied to existing landscapes and yards by mixing with water and using a hose-end sprayer or watering can. Aids in creating a thriving and diverse soil capable of supporting maximum root and plant growth.



.5oz
PLSFGPSOSOL05
UPC 689319013132
Min Buy 10 EA

5lb
PLSPSOSOL5LB
UPC 689319013163
Min Buy 1 EA

4oz
PLSFGPSOSOL4OZ
UPC 689319013149
Min Buy 12 EA

20lb
PLSFGPSOSOL20LB
UPC 689319013187
Min Buy 1 EA

1lb
PLSFGPSOSOL1LB
UPC 689319013156
Min Buy 1 EA



PLANT REVOLUTION

Water Soluble

Plant Success Great White

Premium Mycorrhizae with Beneficial Bacteria & Trichoderma. The cutting edge formula contains 16 different species of mycorrhizal fungi, 14 different species of beneficial bacteria and two species of trichoderma, all-in-one product. This powerful formula will encourage plant and root development, giving plants the tools they need to maximize yields. The premium and concentrated formula aids optimum colonization of root systems by the fungi. The water-soluble powder delivers the spores directly to the roots for immediate germination. Users should look for explosive root development, enhanced yields, fruiting and flowering, nutrient and water absorption and transplant success.



1oz

PLSFGGRWH10Z
UPC 689319012135
Min Buy 12 EA

4oz

PLSFGGRWH40Z
UPC 689319012012
Min Buy 12 EA

8oz

PLSFGGRWH80Z
UPC 689319012029
Min Buy 1 EA

32oz

PLSFGGRWH32OZ
UPC 689319012036
Min Buy 2 EA

5lb

PLSFGGRWH5LB
UPC 689319012043
Min Buy 1 EA

25lb

PLSFGGRWH25LB
UPC 689319012074
Min Buy 1 EA



SLF-100

Liquid

South Cascade Organics SLF-100

SLF-100 is a commercially proven enzymatic formula with over 18 years of proven success. It is a 100% organic and OMRI listed formula specifically designed to break out salts. Used as a cleanser for hydroponic systems and soilless media SLF-100 goes to work immediately to keep your system running smooth and free of toxic build up. It is effective in all phases of the growing cycle and is compatible with all nutrients, fertilizers, rooting compounds, and H2O2. Thanks to a proprietary blend of naturally occurring enzymes, SLF-100 is PH neutral in concentrated form and has NO added sugars or NPK.



1qt

SLFSLFQ
UPC 850014892005
Min Buy 12 EA

1gal

SLFSLF1
UPC 850014892012
Min Buy 4 EA

2.5gal

SLFSLF25
UPC 850014892029
Min Buy 2 EA

5gal

SLFSLF5
UPC 850014892036
Min Buy 1 EA

15gal

SLFSLF15
UPC 850014892043
Min Buy 1 EA

55gal

SLFSLF55
UPC 850014892012
Min Buy 1 EA

275gal

SLFSLF275
UPC 850014892067
Min Buy 1 EA



Other

Hyclean™

HYCLEAN™ is a non-toxic, biodegradable, and environmentally friendly cleaner that removes and prevents the buildup of salts and minerals in irrigation lines and grow media. When paired with your nutrient feed and used from the beginning of your grow cycle, HYCLEAN™ keeps your system and grow media clean, preventing toxicities or imbalances and resulting in a higher quality finished product. HYCLEAN™ can be used while growing to prevent buildup, as a deep clean of your irrigation system in between crops, and as an equipment soak.



500ml

SIP02FGHL500MLUS
UPC 776190999539
Min Buy 12 EA

4L

SIP02FGHL004LTUS
UPC 776190999522
Min Buy 4 EA



Hygrozyme®

Hygrozyme® is a powerful blend of concentrated, beneficial enzymes that work synergistically to ensure plants achieve their full genetic potential. It provides a cleaner root zone by accelerating the break down of dead root matter to prevent root rot and increase nutrient uptake in the plant. Hygrozyme® also contains a proprietary formula that feeds beneficial microbes, supercharging your root zone.

ACTIVE INGREDIENT Cellulase, Xylanase, Hemicellulase, Beta-Glucanase



500ml

SIP02FGHG500MLUS
UPC 776190101017
Min Buy 12 EA

1L

SIP02FGHG001LTUS
UPC 776190101024
Min Buy 12 EA

4L

SIP02FGHG004LTUS
UPC 776190101031
Min Buy 4 EA

10L

SIP02FGHG010LTUS
UPC 776190101048
Min Buy 2 EA

20L Concentrate

SIP02FGHC020LTUS
UPC 776190999997
Min Buy 1 EA

20L

SIP02FGHG020LTUS
UPC 776190101055
Min Buy 1 EA

208L

SIP02FGHG208LTUS
UPC 776190101062
Min Buy 1 EA



Reefertilizer®

Dry

Reefertilizer® BLOOM Fertilizer 5-30-20

Our Reefertilizer BLOOM fertilizer formula is the final step of our fertilizer and nutrients program designed for mature plants. Introducing calcium – as well as increasing the amount of phosphorus available to your plant – will encourage the growth of strong and healthy cannabis and hemp flowers.



750ml

REEBLOOM750

UPC 650966546243

Min Buy 5 EA



Reefertilizer® GROW Fertilizer 20-5-10

Our Reefertilizer GROW fertilizer formula is designed for a plant's vegetative stage. It contains all the essential micro-nutrients – as well as nitrogen, phosphate, and potassium – in proportions that are ideally suited for growing strong and healthy cannabis and hemp plants.



600ml

REEGROW600

UPC 650966546236

Min Buy 5 EA



Reefertilizer® Boxed Trio

Our entire Reefertilizer growing system (START / GROW / BLOOM) packaged together with grow guide and welcoming letter.



REETRIO

UPC 650966546274

Min Buy 5 EA



Reefertilizer® START Soil Conditioner

Our Reefertilizer START formula is 100% organic natural ingredients that promote strong and healthy root growth in clones and young seedlings. Containing only two simple ingredients – Organic kelp granules and Mycorrhizal spores – this soil conditioner greatly expands the plant's ability to absorb water and intake nutrients from the soil.



500ml

REESTART500

UPC 650966546229

Min Buy 5 EA



Reefertilizer® Trio Counter Display

Counter display for the Reefertilizer® growing system



Retail Display

REECOUNTDIS

UPC 691027413982

Min Buy 1 DS



PREMIER TECH PRO-MIX®

Dry

PRO-MIX® Mycorrhizal Inoculant

PRO-MIX® Mycorrhizal Inoculant is a highly concentrated formulation designed to help professional growers to CONNECT and improve the value of their crops. Based on the growth cycle of plants, it is intended to be applied at key moments to ensure a quick connection in order to establish an extra radicular network. The extended root system resulting from the symbiotic relationship allows to enhance water and nutrient uptake, resulting in stronger, healthier crops.



250gr

PRBMC025179NPB

Min Buy 1 CS

5.1lb

PRBMC250179NP

Min Buy 1 EA



YARA

Dry

Yara Calcium Nitrate 15.5-0-0 Greenhouse Grade

A fully water soluble nitrogen and calcium fertilizer. It is a free flowing, fine granular or prilled material which dissolves quickly in water without any residues. Suited to application through all fertigation systems.



50lb (49/PL)

YARA6031 CN

Min Buy 1 BG





Water Soluble

TNB The Enricher Plant Booster

The Enricher is perfect for all types of plants at all stages of growth, from the first day of vegetation to the last two weeks of flowering. This product promotes better yields, greener plants, faster germination, more blooms, stronger plants and bigger roots.



500g/1.1lbs

TNB004

UPC 696859915192

Min Buy 60 EA

1000g/2.2lbs

TNB005

UPC 083832074517

Min Buy 30 EA



TNB Naturals pH Up

TNB Naturals granular pH UP is non-caustic so it won't burn your hands and since it's so gentle, it won't harm the beneficial bacteria. It's even safe for use with aquaponics. TNB pH UP is composed of all natural ingredients with the addition of no harmful chemicals. This innovative way to raise the pH levels of your hydroponic or liquid fertilizer is both simple and cost effective. Simply add a small amount to your water, mix thoroughly and check your pH levels.



1lb Granular

TNB008

UPC 019962590412

Min Buy 30 EA

40lb

TNB010

UPC 019962590115

Min Buy 1 EA



TNB Naturals pH Down

TNB Naturals granular pH DOWN is non-caustic so it won't burn your hands and since it's so gentle, it won't harm the beneficial bacteria. It's even safe for use with aquaponics. TNB pH DOWN is composed of all natural ingredients with the addition of no harmful chemicals. This innovative way to lower the pH levels of your hydroponic or liquid fertilizer is both simple and cost effective. Simply add a small amount to your water, mix thoroughly and check your pH levels.



1lb Granular

TNB009

UPC 019962590313

Min Buy 30 EA

40lb

TNB011

UPC 019962590214

Min Buy 1 EA



Other

TNB Digital Co2 Monitor

The CO2 Monitor and Thermo Hygrometer is a sleek portable unit that has been developed to monitor and display CO2 concentration, ambient temperature and relative humidity, along with the year, month, date and time.



3.5in LCD Display. USB Compatible

TNB003

UPC 083832074616

Min Buy 1 EA



TNB Naturals The Enhancer CO2 Generator

The CO2 Refill Pack gives growers the ability to reuse their existing Enhancer bottle while saving money and reducing their environmental footprint at the same time. Simply empty the contents of the original bottle and give the bottle a quick rinse. The contents of the Refill Pack can be added and instantly CO2 is once again available for use.



240g Refill Pack

TNB002

UPC 696859915208

Min Buy 20 EA



TNB Naturals The Enhancer CO2 Generator

The Enhancer is an all natural CO2 generator made from 100% organic ingredients. This safe and effective solution for CO2 supplementation creates a blast of CO2 that can reach 1200 PPM in a 12x12x12 foot area for up to 2 weeks. Simple and easy to use, The Enhancer does not produce heat or require any additional equipment.



Dispersal Canister

TNB001

UPC 696859235511

Min Buy 15 EA





Liquid

SUPERthrive® Vitamin Solution 0.5-0-0

SUPERthrive is a highly concentrated, non-toxic vitamin solution enhanced with kelp that builds vigor of all varieties of greenery for home gardeners and professionals. It is equally suited for hydro-seeding, hydroponics, and foliar spraying. Use in tandem with your nutrient regimen.



4oz
VIT00014

UPC 072532000148
Min Buy 12 EA

16oz
VIT00015

UPC 072532000155
Min Buy 1 EA

32oz
VIT00016

UPC 072532000162
Min Buy 1 EA

1gal
VIT00017

UPC 072532000179
Min Buy 1 EA

2.5gal
VITST25GALLON2

UPC 072532000193
Min Buy 2 EA

15gal
VITST15GALLON

UPC 072532000209
Min Buy 1 EA



SuperThrive® Plant Food 4-1-1

SUPERthrive is a highly concentrated, non-toxic vitamin solution enhanced with kelp that builds vigor of all varieties of greenery for home gardeners and professionals. It is equally suited for hydro-seeding, hydroponics, and foliar spraying. Use in tandem with your nutrient regimen. OMRI Listed suitable for organic gardening.



32oz

VITSTFOOD328

UPC 072532332089

Min Buy 8 EA

Superthrive® Spray 0.005-0-0

Super thrive is a kelp enhanced, natural vitamin solution that helps promote plant health from seedling to maturity. Trusted by professional farmers & growers since 1940, SUPERthrive is now available in a ready-to-use formula for the home gardener. Easy to apply; just spray foliage every 2-3 days. Superthrive helps: promote plant health build plant vigor use with: seedlings & cuttings outdoor flowers & vegetable plants indoor houseplants & bonsai. Directions for use: use as soon as first true leaves appear spray both sides of leaves until moistened use every 2-3 days throughout plant lifecycle if applicator becomes clogged, remove sprayer & soak in warm water to clear. To avoid potential leaf burn, apply in the early morning. Covers up to 100 square feet. For best results, use with SUPERthrive plant food.



23oz

VITSTSPRAY10

UPC 072532223103

Min Buy 10 EA



Dry

Xtreme Gardening® CalCarb Foliar Booster

CalCarb is a readily available source of calcium and carbon dioxide. Calcium is critical to the health of your plant, contributing to the strength of cell membranes and regulation of nutrient use. Calcium is known to play a major role in the quality of many crops, including peppers, tomatoes, and watermelons. CalCarb is also able to reduce the effects of heat stress on plants. CalCarb foliar booster works great in both indoor and outdoor environments.



3oz
RTI2504

UPC 794504426311
Min Buy 12 EA

6oz
RTI2505

UPC 705105758473
Min Buy 12 EA



Xtreme Gardening® Azos® Root Booster

Azos® is a beneficial microbe that forms a symbiotic relationship with your plant, converting atmospheric nitrogen into a useable form that your plants can uptake. Nitrogen is critical for forming vegetative matter and supporting abundant growth. Azos promotes growth, while boosting natural root development. As always Xtreme Gardening products are free of GMO's (genetically-modified organisms) & harmful pesticides.



2oz
RTI1349

UPC 794504911312
Min Buy 12 EA

6oz
RTI1350

UPC 705105758374
Min Buy 12 EA

12oz
RTI1351

UPC 689076048361
Min Buy 6 EA

8lbs
RTI1352

UPC 736211255457
Min Buy 1 EA

20lbs
RTI1353

UPC 019962505904
Min Buy 1 EA





Dry

Xtreme Gardening® Mykos®

Mykos® is a fast-growing, beneficial fungus that increases nutrient and water uptake by forming a symbiotic relationship with the roots of a plant. Mykos® is needed to break down, cycle, and retain nutrients as well as provide a front line of defense against environmental stresses, pathogens, and diseases. Mykos® will continue to grow with your plants becoming an extension of the roots and administering better efficiency and sustainability. With a larger and healthier root system, plants are given the opportunity to increase crop yields and secondary metabolites.



100g - 60ct Display

RTI6502

UPC 689076464864

Min Buy 1 EA

1lb

RTI4401

UPC 689076957359

Min Buy 12 EA

2.2lbs

RTI4402

UPC 689076048460

Min Buy 6 EA

20lbs

RTI4403

UPC 705105761176

Min Buy 2 EA

50lb

RTI4404

UPC 794504426519

Min Buy 1 EA



Xtreme Gardening® Mykos® Root Paks

Mykos® mycorrhizae is a natural and organic species of beneficial soil fungi that create a "sponge-like" mass which collects and stores nutrients and water, increasing the uptake of both. Contains Rhizophagus intraradices (300 propagules / gram). Improves Efficiency of Nutrients & Water. Enhances Root Structures for Added Uptake Capabilities. Can Increase Yields & Secondary Metabolites. Fastest & Most Aggressive Colonizing Mycorrhizae. Great for Vegetables, Fruits, Herbs & Flowers.



50ct - 6/cs

RTI4201

UPC 705105758572

Min Buy 6 EA

500 ct - 2/cs

RTI4202

UPC 736211711830

Min Buy 2 EA



Dry

Xtreme Gardening® Mykos® WP

Mykos® is a natural and organic species of beneficial soil fungi that create a "sponge-like" mass which collects and store nutrients and water, increasing the uptake of both. Mykos® arbuscular mycorrhizal fungi contains Rhizophagus intraradices, formally known as Glomus intraradices. Mykos® does not contain any other microbes such as Trichoderma or ectomycorrhizae.



12oz - Wettable Powder

RTI2202

UPC 736211378019

Min Buy 12 EA

2.2lbs - Wettable Powder

RTI2203

UPC 736211711731

Min Buy 6 EA

15lbs - Wettable Powder

RTI2204

UPC 736211378217

Min Buy 2 EA



Xtreme Gardening® Tea Brews

Xtreme Gardening® Tea Brews has a unique, two-part system that keeps the product stable until the time of use. The tea brew pouch contains compost material and the microbe food pack provides a food source designed to multiply microbes during the brewing process. Our special blend of organic matter has been shown to break down nutrients and make them available to your plants as well as increase the microbial population in the rhizosphere.



10ct

RTI8100

UPC 736211919458

Min Buy 6 EA

14 ct

RTI8106

UPC 736211031990

Min Buy 2 EA

20ct

RTI8110

UPC 794504462104

Min Buy 20 EA



Liquid

Xtreme Gardening® Azos® Red Liquid

A pure, fresh, and living bacterial inoculant; Azos Red Liquid is a naturally occurring bacteria that benefit plant growth. Azos converts atmospheric nitrogen into a useable form that is readily available to the plants. Great for container, raised beds, and row crops.



500mL

RTI1356

UPC 019962506109

Min Buy 4 EA



GROWER'S ALLY[®]

SPIDER MITE CONTROL & FUNGICIDE



Maximize Yields

**25(b)
EXEMPT**

Zero Pollutants



Harvest Same Day



No Reported Phytotoxicity



0-Hour Re-Entry



Minimal PPE

TRUSTED SOLUTIONS FOR CULTIVATORS



Saved Our Grow

"Spider Mite Control saved our grow and allowed us to have a good harvest. We are highly satisfied with your product and look forward in doing business in the future."

Andrew



Backbone To My IPM

"Grower's Ally is a must have for extremely effective preventative and reactive plant maintenance. Most importantly I can use it in all phases. It is the backbone to my IPM."

Brian

VISIT [GROWERSALLY.COM](https://growersally.com) TO LEARN MORE



INSECT & DISEASE
Control



Biologicals

BASF® Nemasys® Beneficial Nematodes

Nemasys (steinernema feltiae) beneficial nematodes provide biological control of Thrips and the soil dwelling stages of Fungus Gnats. They attack and kill targeted pests without affecting any other organisms.

ACTIVE INGREDIENT Steinernema feltiae



5 Trays of 250 Million 5 Trays of 50 Million

BAS59014486

BAS59014493

Min Buy 1 CS

Min Buy 5 EA



Fungicides & Bactericides

Pageant® TR Intrinsic® Fungicide

Pageant is a broad-spectrum fungicide that is effective on many plant diseases. Pageant Intrinsic brand fungicide also provides plant health benefits such as improved tolerance to stress and increased efficiency of plant processes. Total release fogger. Can also be used in the cargo area of trucks to protect plants during transportation.

ACTIVE INGREDIENT Boscalid & Pyraclostrobin



3oz aerosol

BAS59012766

Min Buy 1 EA



Trinity® TR Fungicide

Provides broad spectrum control of several key diseases. Total release fogger. For use in greenhouses on bedding plants, cut flowers, flowering hanging baskets, foliage, potted flowering plants, ornamentals and perennials.

ACTIVE INGREDIENT Triticonazole



4oz aerosol

BAS59012781

Min Buy 1 BT



Insecticides & Miticides

Sensor® Yellow Sticky Cards

Durable, long-lasting pest monitoring and trapping cards are designed to catch a variety of pests, including aphids, leafminer, thrips, whiteflies, fungus gnat and other flying insects. Offers growers the best way to eliminate guesswork and evaluate if insect control programs are working. Features non-sticky edges for easier handling.



50pk

BAS45182529

Min Buy 1 PK



Insecticides & Miticides

Attain® TR Insecticide

A ready-to-use, ultra-low-volume insecticide fogger that controls a variety of greenhouse insect pests, including aphids, fungus gnats, mealybugs, mites, thrips and whiteflies, along with several other secondary insect pests.

ACTIVE INGREDIENT Bifenthrin



2oz

BAS59011825

UPC 804338118259

Min Buy 1 BT



Beethoven® TR Miticide / Insecticide

Beethoven TR provides control of mites including two-spotted spider mites and suppresses whiteflies. Total release fogger. Beethoven offers quick and easy application, thorough coverage and excellent plant safety.

ACTIVE INGREDIENT Etoxazole



2oz aerosol

BAS5902321

UPC 804338123215

Min Buy 1 BT



Velifer® Fungal Contact Insecticide/Miticide

Velifer fungal contact insecticide/miticide provides control of tough greenhouse pests through direct contact and application. Product is compatible with beneficial insects.

ACTIVE INGREDIENT Beauveria bassiana strain PPRI 5339



32oz bottle

BAS59018345

Min Buy 1 QT



Pylon® TR Miticide / Insecticide

A broad-spectrum miticide / insecticide that provides control of mites, thrips and adult fungus gnats. Controls the target insect or mite by interfering with energy production of the pests. Its translaminar movement and mode of action results in mortality of most pests in 72 hours.

ACTIVE INGREDIENT Chlorfenapyr



2oz aerosol

BAS59012595

Min Buy 1 BT

16oz bottle

BAS59012156

UPC 049961998612

Min Buy 1 PT



Pyrethrum® TR Insecticide

Total release insecticide fogger for indoor use in Garden Centers, Greenhouses and Nurseries. Fast and easy control of many pests including Aphids, Beetles, Fungus Gnats, Caterpillars and many more. For use on ornamentals, flowering plants, vegetables, hanging baskets, bedding plants and more.

ACTIVE INGREDIENT Piperonyl butoxide and Pyrethrins



2oz aerosol

BAS59011861

UPC 804338118617

Min Buy 1 BT



Fungicides & Bactericides

OxiDate® 2.0 Bactericide/Fungicide

Treat and control plant pathogens on a wide range of crops. It is a keystone chemistry that strengthens conventional and organic IPM programs by reducing disease pressure.

ACTIVE INGREDIENT Hydrogen peroxide and peroxyacetic acid



2.5gal Bottle

BSF510025

UPC 188716000047

Min Buy 1 BT

OxiPhos® Fungicide / Bactericide

Use throughout the season to treat and control pythium, phytophthora, bacterial blights, downy mildew, and more. OxiPhos has a dual mode of action (systemic and contact) and can be applied as a foliar spray or root drench and is tank mix compatible with ZeroTol® 2.0 and AzaGuard®.

ACTIVE INGREDIENT Phosphorus acid and Hydrogen Peroxide



2.5gal

BSF7700-2.5

Min Buy 1 EA

55 Gal drum

BSF770055

Min Buy 1 DR

5gal

BSF77005

Min Buy 1 EA

Biologicals

BioCeres WP Insecticide

BioCeres WP uses a proprietary strain of *Beauveria bassiana* fungus to target foliar feeding or soil-borne insect pests and is perfectly suited for reducing insecticide resistance in IPM programs.

ACTIVE INGREDIENT *Beauveria bassiana*



1lb

BSF68001

Min Buy 1 EA

Insecticides & Miticides

AzaGuard® Insecticide / Nematicide

Control over 400 insect species. The primary mode of action of this product is as a growth regulator, preventing immature insects from developing into adults. However, AzaGuard can also be used as an oviposition deterrent, antifeedent, repellent, molting inhibitor, sterilant and growth retardant.

ACTIVE INGREDIENT Azadirachtin



32oz

BSF7000-32OZ

Min Buy 1 QT

1gal

BSFT070001

UPC 188716000061

Min Buy 1 GL

Herbicides

AXXE® Broad Spectrum Herbicide

Controls grasses and broadleaf weeds, mosses, liverworts and lichens around facilities to deter cross contamination from pests. AXXE Broad Spectrum Herbicide burns down weeds within hours of application and leaves no harmful residues. This product does not volatilize or migrate through soil and is ideal for use in all areas of production inside and outside.

ACTIVE INGREDIENT Ammonium nonanoate



2.5gal

BIOS7600-2.5

Min Buy 1 BT

Sanitizers, Cleaners, Disinfectants

BioFoamer Foaming Agent

Additive for use in foaming equipment to enhance foam during application. Ensures that foam delivers thorough coverage and extended contact time on treated surfaces, increasing efficacy of cleaning agent or crop protection product such as SaniDate 5.0 or ZeroTol 2.0.



5gal

BSF9005-5

Min Buy 1 EA

GreenClean® Granular Algaecide

Works quickly through the power of oxidation, breaking down algae cells on contact. GreenClean Granular Algaecide releases vital oxygen into the water as it biodegrades, and is ideal for use in water features containing fish, plants and aquatic life.



2.5lb

BSF300225

UPC 188716000252

Min Buy 1 EA

8lb

BSF30028

UPC 188716000276

Min Buy 4 EA

SaniDate® All Purpose Disinfectant

Clean, disinfect and deodorize hard, non-porous surfaces in one step! Use daily to clean dirt, grime, oils and other common soils on hard, non-porous surfaces. EPA-registered to kill human coronavirus.

ACTIVE INGREDIENT Peroxyacetic Acid and Hydrogen Peroxide



1gal

BSF20461

UPC 188716000948

Min Buy 1 EA



BioSafe Systems®

Sanitizers, Cleaners, Disinfectants

SaniDate® Hard Surface Sanitizer

Activated peroxide chemistry that cleans, sanitizes, deodorizes, and kills 99.9% of bacteria on hard, non-porous surfaces. Kills E. coli, Salmonella, and Staphylococcus Aureus and Klebsiella on contact. Chlorine and ammonia-free formula. Leave no harmful residue and no rinsing required.

ACTIVE INGREDIENT Hydrogen Peroxide



32oz RTU

BSF201832

UPC 188716000726

Min Buy 12 EA



GreenClean® PRO Algaecide/Fungicide/Bactericide

Treat and control algae on concrete walkways, ground cloth, or dirt, or gravel floors, and other hard surfaces to improve workplace safety. Additionally, GreenClean PRO can be used to treat water storage tanks and irrigation ponds to reduce algae and waterborne pathogens.

ACTIVE INGREDIENT Sodium Carbonate Peroxyhydrate



50lb

BSF3300-50

Min Buy 1 BG



SaniDate® Sanitizing Wipes

Single-use wipes for quick sanitation of hard non-porous surfaces. This activated peroxide sanitizer is ideal for use on the go, is easy to use and store and can be handled without PPE.

ACTIVE INGREDIENT Hydrogen Peroxide



125ct

BSF2015125

UPC 188716000788

Min Buy 6 EA



SaniDate® 12.0 Bactericide, Fungicide

For use in commercial, industrial, agricultural, postharvest, and horticultural water treatment applications. Labeled for fruit and vegetable processing to control spoilage.

ACTIVE INGREDIENT Hydrogen Peroxide and Peroxyacetic Acid



30gal Drum

BSF200630

Min Buy 1 DR



BioSafe Systems Spigot

Tip and pour spigot for BioSafe Systems' 2.5 and 5 gallon containers.



BSF190610L

Min Buy 1 EA



SaniDate® 5.0 Sanitizer / Disinfectant

The ideal cleaner, sanitizer, and disinfectant for hard, nonporous surfaces and equipment with no rinse required. Foam, fog, or apply solution with a mop, cloth, sponge, brush, scrubber, or coarse spray device or by soaking. SaniDate 5.0 brings peace of mind to management, staff, and consumers with its no residue formula and minimal REI.

ACTIVE INGREDIENT Hydrogen Peroxide and Peroxyacetic Acid



2.5gal

BSF200325

Min Buy 1 BT

30gal Drum

BSF200330

Min Buy 1 DR

5gal

BSF20035

Min Buy 1 BT

55gal Drum

BSF200355

Min Buy 1 DR



GreenClean® Acid Cleaner

Removes greenhouse whitewash coatings, biofilms, organic deposits, calcium and other hard minerals. The formulation of surfactants and organic acid detergents will help lift away organic mineral deposits without harsh odors.



5gal

BSF7500-5

Min Buy 1 BT

55gal drum

BSF750055

Min Buy 1 DR



Sanitizers, Cleaners, Disinfectants

ZeroTol® HC Algaecide, Bactericide, Fungicide

Quickly eliminate plant pathogens such as powdery mildew, botrytis, and pythium. ZeroTol HC is ideal for the indoor or hydroponics grower with under 500 sq. ft. Use as a foliar spray, hard surface treatment, and in hydroponics or aquaponics systems.

ACTIVE INGREDIENT Hydrogen peroxide and peroxyacetic acid



1gal
BSF62001
 UPC 188716000931
 Min Buy 1 GL

ZeroTol® 2.0 Algaecide, Bactericide, Fungicide

Treat and control foliar and root diseases on contact. ZeroTol 2.0 is ideal for food crops, cannabis, and more. Leaves no harmful residue and can be applied as a foliar spray or drench.

ACTIVE INGREDIENT Hydrogen peroxide and peroxyacetic acid



2.5gal
BSF600025
 UPC 188716000160
 Min Buy 1 BT

55gal Drum
BSFTO600055
 Min Buy 1 DR

30gal Drum
BSFTO600030
 Min Buy 1 DR

Insecticides & Miticides

Arborjet® Eco-1® Garden Spray

Botanical insect, mite and disease control, derived from plant oils. Safe to use on fruits, vegetables, herbs, roses, flowers, houseplants, trees and shrubs. Harvest same day.

ACTIVE INGREDIENT Lindseed Oil, Thyme Oil, Peppermint Oil Concentrate 12% active RTU 1.19% active



32oz Ready-to-Use
ARJ0407300
 UPC 811890016947
 Min Buy 6 EA

1gal Concentrate
ARJ0407350
 UPC 811890017067
 Min Buy 2 EA

Biologicals

Arborjet® AzaSol® Bio-Insecticide

The Next Generation Neem – A water soluble 6% Azadirachtin powder insecticide and insect growth regulator, from the Neem tree. Provides an exceptionally potent, non-oil based, and environmentally friendly insect control solution for shrubs, turf, garden, vegetables, fruit trees, and herbs. Can be used as a spray, soil drench, or through chemigation. Leaves no oily residue, will not clog of equipment, Won't burn leaves or block photosynthesis, is systemic and translaminar (Absorbed through leaves) and can be used the same day harvest. OMRI Listed for Organic Use.

ACTIVE INGREDIENT Azadirachtin 6%



0.75oz Single Packet
ARJ0405011
 UPC 811890018125
 Min Buy 1 EA

.25oz
ARJ0405020
 UPC 811890018385
 Min Buy 6 EA

6oz (8 packets, 0.75oz each)
ARJ0405001
 UPC 811890016923
 Min Buy 1 EA

Other

CapSil® Spray Adjuvant

Waxy leaf surfaces can cause spray droplets to bead up, resulting in coverage gaps that can reduce the efficacy of foliar sprayed materials. CapSil® allows foliar sprays to spread evenly over the entire leaf surface, giving you full coverage with every application. CapSil is a 100% active blend of organo-silicone and non-ionic surfactants that enables solutions to spread over the entire leaf surface evenly.

ACTIVE INGREDIENT Polyether-polymethylsiloxanecopolymer



1gal
AQCAP-4X1
 UPC 049961976108
 Min Buy 1 GL





Insecticides & Miticides

Hot Shot® No-Pest® Strip

Kills flying and crawling insects with a penetrating, odorless vapor. Continuous protection for up to 4 months. Just hang or stand it up in attics, garages and more. One strip will treat a 10ft x 13ft room with an 8ft ceiling.



2.29oz
UICHG55806
 UPC 071121055804
 Min Buy 12 EA



Biologicals

Biologicals

Regalia® CG Fungicide / Bactericide

Regalia's unique mode of action of Induced Systemic Resistance (ISR) brings a sustainable option to help simplify and extend your IPM program. It can be used as a stand-alone product, in rotation with or in combination with other fungicides to strengthen IPM programs and to help manage resistance in organic & conventional crops, and turf and ornamentals. Regalia also improves the crop's tolerance to stress by enhancing overall plant health.

ACTIVE INGREDIENT Reynoutria sachalinensis



1qt MB10084 UPC 850013238019 Min Buy 1 EA	2.5gal MB10096 UPC 850013238057 Min Buy 1 BT
1gal MB10081 UPC 850013238033 Min Buy 1 GL	55gal Drum MB10090 UPC 850013238217 Min Buy 1 DR



Stargus® Fungicide

Stargus® is a biological fungicide for control of fungal and bacterial plant diseases. Use sites include field and greenhouse crops. Can be used on bushberries and caneberries, bulb vegetables, citrus crops and most vegetables.

ACTIVE INGREDIENT bacillus amyloliquefaciens strain F727



2.5gal
MB10077
 Min Buy 1 BT



Grandevo® CG Insecticide / Miticide

Grandevo® is a microbial-based insecticide. Grandevo contains several active compounds that repel, stop feeding, reduce reproduction and induce mortality to prevent the development of damaging populations of sucking and chewing insects, flies and mites. Grandevo can be used on a wide range of organic and conventional crops, including fruits, vegetables, nuts and turf and ornamentals.

ACTIVE INGREDIENT Chromobacterium subsugae strain PRAA4-1



1lb MB10085 UPC 850013238132 Min Buy 1 EA	4lb Bag MB10082 UPC 850013238156 Min Buy 1 EA
---	---



Venerate® CG Insecticide / Miticide

Venerate bioinsecticide features multiple modes of action is effective against a wide variety of chewing and sucking insects and mites, yet easy on beneficials. The unique and novel modes of action will complement and improve integrated pest management and insect resistance management programs.

ACTIVE INGREDIENT Burkholderia spp. Strain A396 cells



1qt MB10086 UPC 850013238071 Min Buy 1 QT	2.5gal MB10097 UPC 850013238118 Min Buy 1 BT
1gal MB10083 UPC 850013238095 Min Buy 1 GL	



Other

Jet-Ag® Fungicide

Jet-Ag prevents and suppresses fungi, bacteria, and algae. As a foliar spray it begins working immediately on contact with any plant surface for control/suppression of plant pathogens. Labeled for use on ornamentals, nursery stock, bedding plants, and flowering plants. Can also be used a pre-plant dip or as a soil drench.



2.5gal
MB10109
 Min Buy 1 BT





POWDERY MILDEW | PYTHIUM ROT | BOTRYTIS

FUNGICIDE & PLANT HEALTH

Use early for disease prevention and overall plant health, and late in season to avoid issues of pesticide residues at harvest.

- ✓ Better yield & harvest quality
- ✓ Stimulates plant immunity & fights disease
- ✓ Quality control tested to ensure no human microbial pathogens
- ✓ Tank mix friendly: Can be mixed with Grandevo CG Bioinsecticide or Venerate CG Bioinsecticide

BASIC USE INSTRUCTIONS

Transplant Dip: Roots and foliage benefit from a quick dip in a solution of 1 tbsp/gal.

Drench: 1-2 tbsp/gal. solution. 14-day intervals.

Foliar: 2 tbsp/gal. of water – use up to 2 gallons of diluted solution per 1,000 sqft. Apply at 7-day intervals.



2 tbsp or 30 ml per gallon
1-2 gallons per 1000 sq. ft.

Always read & follow label instructions

POWDERY MILDEW AND BOTRYTIS BUD ROT - CANNABIS

Farm Forest Research

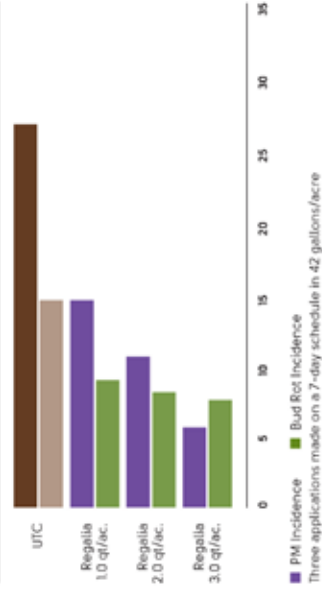

MITES | THRIPS | APHIDS

MODERN PEST MANAGEMENT

- ✓ Prevents crop damage when used early
- ✓ Reduces reproduction, induces mortality, stops feeding & repels insects
- ✓ Soft on beneficials
- ✓ Tank mix friendly: Rotate with Venerate CG Bioinsecticide



BASIC USE INSTRUCTIONS

Foliar: 2-4 tbsp/gal. of water per 1,000 sqft. Apply at 7-day intervals. Alternate with Venerate® CG Bioinsecticide.



2-4 tbsp or 28.6-57.2 grams per gallon per 1,000 sq. ft.

Always read & follow label instructions

GRANDEVO CG AND VENERATE CG ON MITES AVERAGE #/LEAFLET

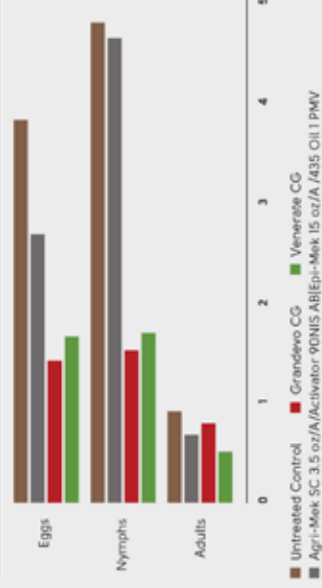

MITES | THRIPS | APHIDS | ARMYWORMS

IMPROVE INSECT CONTROL

- ✓ Apply weekly to combat key pests
- ✓ Protects against sucking & chewing insects & mites
- ✓ Increases crop yield and quality
- ✓ Tank mix friendly: Rotate with Grandevo CG Bioinsecticide



BASIC USE INSTRUCTIONS

Drench: 2.5-5 tbsp/gal. solution. 10 to 14-day intervals.

Foliar: 2-5 tbsp/gal. of water per 1,000 sqft. Apply at 7-day intervals. Alternate with Grandevo CG Bioinsecticide.



2.5-5 tbsp or 37.5-75 ml per gallon per 1,000 sq. ft.

Always read & follow label instructions

VENERATE CG AGAINST THRIPS

Dr. Van Steenwyk, UC Berkeley

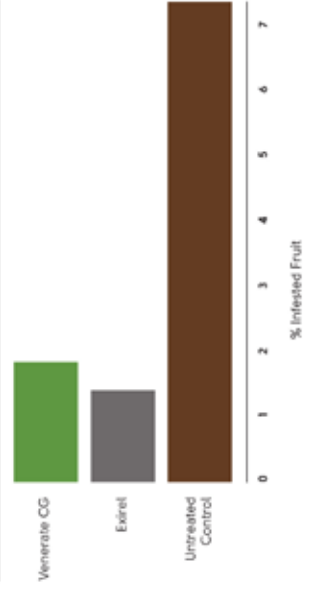



Biologicals

Ancora® Microbial Insecticide

Ancora contains a naturally occurring fungus that infects both foliage and soil insect pests. Ancora is compatible with beneficial arthropods and is labeled for use on herbs, vegetables and ornamentals. Ancora has a 4-hour REI and can be used in organic production.

ACTIVE INGREDIENT Isaria fumosorosea Apopka strain 97



1lb

OHP981070

UPC 896531002510

Min Buy 1 BG



Azatin® O Insecticide

Azatin O is a biological insect growth regulator used to control the larval stage of a broad-spectrum of greenhouse and nursery pests. Azatin O is OMRI listed for organic production and is soft on beneficial insects. Suitable for use on crops such as ornamentals, vegetables, herbs and berries grown in the greenhouse, nurseries, interiorscapes, hydroponics and turf.

ACTIVE INGREDIENT Azadirachtin



32oz

OHP981221

Min Buy 1 QT



Biologicals

Triathlon BA® Biofungicide / Bactericide

A broad-spectrum preventative biofungicide for control of a wide variety of fungal and bacterial diseases on ornamentals, fruits, vegetables, herbs and spices grown in greenhouses, nurseries and shade houses, Triathlon BA is approved for use in organic production.

ACTIVE INGREDIENT Bacillus amyloliquefaciens strain D747



1gal

OHP988544

Min Buy 1 BT



Kopa® Insecticidal Soap

Kopa insecticidal soap for control of insect and mite pests on vegetables, fruits and ornamental plants grown in greenhouses and outdoors.

ACTIVE INGREDIENT Potassium salts of fatty acids



2.5gal

OHP985025

UPC 896531002527

Min Buy 1 EA



Insecticides & Miticides

Floramite® SC Miticide

Produces quick knockdown through contact activity and long residual control of more than 21 days. Soft on predacious mites and beneficial insects. Provides outstanding control of a variety of mite pests on ornamental plants. Labeled for commercial greenhouses and nurseries

ACTIVE INGREDIENT Bifenazate



32oz

OHP982718

UPC 896531002145

Min Buy 1 QT



Triact 70® Botanical Oil

A broad-spectrum fungicide, miticide and insecticide. Highly effective and economical botanical oil that may be used indoors as well as outdoors on ornamental flowering plants, trees, shrubs and foliage grown in greenhouses, interiorscapes and commercial landscapes. As a fungicide, it is a preventative as well as a curative. It coats fungal spores and then dehydrates them to stop the disease cycle.

ACTIVE INGREDIENT Neem oil



2.5gal

OHP988500

UPC 049961998704

Min Buy 1 BT



Floramite® SC/LS Miticide

Produces quick knockdown through contact activity and long residual control of more than 21 days. Soft on predacious mites and beneficial insects. Provides outstanding control of a variety of mite pests on ornamental plants. Labeled for interiorscapes, landscapes and residential (not for plants grown for resale).

ACTIVE INGREDIENT Bifenazate



8oz

OHP982714

Min Buy 1 EA





BioWorks®

Biologicals

BioWorks® MilStop® SP Foliar Fungicide

MilStop® SP is a broad spectrum foliar fungicide. Highly effective on powdery mildews, it also helps prevent other foliar diseases. Use sites include greenhouse, nursery and fields crops. It can also be used on interiorscapes and woody herbs.

ACTIVE INGREDIENT Potassium bicarbonate



5lb bag

BW1M112B04

Min Buy 1 EA



Bioworks® PERpose Plus®

A broad-spectrum algaeicide and fungicide for the prevention, suppression and control of fungus and algae on equipment and hard surfaces, in all stages of crop production, and for post-harvest and storage applications



55gal

BW1HP44A57

Min Buy 1 EA



BioWorks® R.S.S.I.™ WP Microbial Inoculant

R.S.S.I.™ is a microbial soil inoculant that can be drenched on all types of vegetables, herbs, ornamentals and tree seedlings. It will augment the natural microbial activity in the soil and increase the available nutrients to the plant.

ACTIVE INGREDIENT Trichoderma harzianum strain T-22 + Trichoderma virens strain G-41



30lb bag

BW2HR41A07

Min Buy 1 BG



BotaniGard® 22WP Mycoinsecticide

BotaniGard 22WP is a mycoinsecticide for the control of Whitefly, Aphids, Thrips and more. Labeled for use on ornamentals and vegetables in greenhouses, nurseries, commercial landscapes, interiorscapes and turf. Wettable powder formulation.

ACTIVE INGREDIENT Beauveria bassiana strain GHA



1lb

BW1B15A02

UPC 049961998780

Min Buy 1 EA



BotaniGard® ES Mycoinsecticide

BotaniGard ES is a mycoinsecticide for the control of Whitefly, Aphids, Thrips and more. Labeled for use on ornamentals and vegetables in greenhouses, nurseries, commercial landscapes, interiorscapes and turf. Liquid formulation.

ACTIVE INGREDIENT Beauveria bassiana strain GHA



32oz

BW1B14A22

UPC 049961998797

Min Buy 1 QT

1gal

BWB14A23

UPC 049961984424

Min Buy 1 GL



BotaniGard® Maxx Insecticide

BotaniGard Maxx is an insecticide for the control of Whitefly, Aphids, Thrips and more. Labeled for use on ornamentals and vegetables in greenhouses, nurseries, commercial landscapes, interiorscapes and turf. Emulsifiable dispersible oil formulation of Beauveria bassiana and natural pyrethrins.

ACTIVE INGREDIENT Beauveria bassiana and natural pyrethrins



32oz

BW1B103A22

Min Buy 1 QT

2.5gal

BW1B103A24

Min Buy 1 BT



CEASE® Microbial Fungicide / Bactericide

Cease microbial fungicide controls a wide array of fungal and bacterial pathogens, both foliar and soil-borne. For use on ornamentals, trees, shrubs and greenhouse vegetables. OMRI listed.

ACTIVE INGREDIENT Bacillus subtilis strain QST 713



1gal

BW300100

UPC 049961204508

Min Buy 1 GL

2.5gal

BW1C19A24

Min Buy 1 BT



Insect Monitoring Sticky Cards (Blue + Yellow)

Features a unique double sided yellow / blue format. The Yellow side attracts flying adult aphids, whitefly, fungus gnats, leaf miners and more. Blue side attracts flying adult thrips. Each card is 4in x 5in with 1in grid on both sides for easy monitoring. Weather resistant with a easy peel-off backing. Includes a hole punched for hanging.



100pk

BW1GS40A41

Min Buy 1 BX

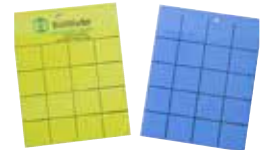

Molt-X® Insect Growth Regulator

Molt-X is an insect growth regulator for control of a wide variety of greenhouse pests. Safe for beneficial insects. Labeled for use on greenhouse vegetable and ornamental crops, nursery, turf, trees and shrubs.

ACTIVE INGREDIENT Azadirachtin



32oz

BW1MX27A22

Min Buy 1 QT

1gal

BW1MX27A23

Min Buy 1 GL





BioWorks®

Biologicals

Mycotrol® ESO Mycoinsecticide

Mycotrol ESO is a mycoinsecticide for the control of Whitefly, Aphids, Thrips and more. Labeled for use on ornamentals and vegetables in greenhouses, nurseries, commercial landscapes, interiorscapes and turf. Organic version of BotaniGard.

ACTIVE INGREDIENT Beauveria bassiana strain GHA



1gal

BA1B16A23

Min Buy 1 EA



NemaShield® Steinernema Beneficial Nematodes

Provides excellent biological control of fungus gnats by eliminating damaging fungus gnat larvae. A single application is sufficient for preventing fungus gnat outbreaks or for control in the beginning phase of an outbreak. Effective in a Western Flower Thrips control program for treatment of pupae and pre-pupae. It will also control thrips species that spend a portion of their life cycle in the soil or potting media.

ACTIVE INGREDIENT Steinernema feltiae



100 Million Pack

BW1N20A26

Min Buy 1 EA

250 Million Pack

BW1N20A27

Min Buy 1 EA



SuffOil-X® Insecticide / Miticide / Fungicide

Suffocates and kills eggs, larvae, nymphs and adult soft bodied insects and mites and controls fungi including powdery mildew. The unique spray oil emulsion formulation stays in suspension better than other oils and the smaller oil particles provide uniform coverage with less chance of phytotoxicity. Use on vegetables, nursery, landscape, ornamental and greenhouse crops.

ACTIVE INGREDIENT Mineral Oil



2.5gal

BW1SX25A24

Min Buy 1 BT



RootShield® PLUS+ Granules Biofungicide

Preventative control of major root diseases including Phytophthora, Rhizoctonia, Pythium, Fusarium, Thielaviopsis and Cylandrocladium. Grows on roots "shielding" them against root damaging fungi. One application provides up to 12 weeks of protection. Contains two active ingredients (Trichoderma harzianum strain T-22 and Trichoderma virens strain G-41).

ACTIVE INGREDIENT Trichoderma harzianum Rifai strain T-22 and Trichoderma virens strain G-41



40lb

BW2HR46A08

Min Buy 1 EA

1,000lb

BW2HR46A11

Min Buy 1 BG



RootShield® WP Biofungicide

RootShield biological fungicide formulated as wettable powder for drench or dip. RootShield grows on roots, shielding them against fungi. One application protects for up to 12 weeks.

ACTIVE INGREDIENT Trichoderma harzianum Rifai strain T-22



1lb

BWRSWP1

Min Buy 1 BG

3lb

BW2H02A03

UPC 049961984448

Min Buy 1 BG



RootShield® PLUS+ WP Biofungicide

RootShield Plus biological fungicide formulated as wettable powder for drench or dip. RootShield Plus grows on roots, shielding them against fungi. Two active ingredients for enhanced disease control. One application protects for up to 12 weeks.

ACTIVE INGREDIENT Trichoderma harzianum Rifai strain T-22 and Trichoderma virens strain G-41



1lb

BW2HR45A02

Min Buy 1 LB

30lb

BW2HR45A07

Min Buy 1 EA





Insecticides & Miticides

Altus® Insecticide

Altus Insecticide is used for the control of insect pests in a wide variety of greenhouse vegetable and ornamental crops and in outdoor nursery and landscape ornamentals. A broad-spectrum insecticide that is acropetally systemic, moving from roots to the leaves in the case of soil applications. Moves translamarily through the leaf tissue in the case of foliar applications and can provide control of pests on the underside of leaves.

ACTIVE INGREDIENT Flupyradifurone



64oz
BYR84989509
Min Buy 1 BT



Kontos® Insecticide

Highly effective control of sucking pests including Adelgids, Aphids, Leafhoppers, Mealybugs, Psyllids, Scales, Thrips and Whiteflies. Up to 30 days of residual control. Can be applied by spray or drench application. For use in nurseries, greenhouses and interior plantscapes on ornamentals, vegetable transplants and non-bearing fruit trees.

ACTIVE INGREDIENT Spirotetramat



250ml (8.45oz)
BYR84915440
Min Buy 1 EA



BLACKSMITH BIOSCIENCE



Biologicals

NoFly® WP Biological Pesticide

NoFly WP mycoinsecticide is a high concentration of the active ingredient *Isaria fumosoroseus* strain FE 9901, a naturally occurring insecticidal microorganism. This aggressive fungus is a natural predator to select insect pests while non-pathogenic to beneficials. NoFly WP is also compatible with many chemicals and is effective against Whitefly, Thrips, Aphids, and Mealy bugs. Labeled for use on greenhouse and nursery ornamentals.



8oz bag
BBSLGNF0080
Min Buy 1 EA

2lb bag
BBSLGNF0022
UPC 865724000268
Min Buy 1 EA



Fungicides & Bactericides

Central Coast Garden Products Root Cleaner

Root Cleaner kills the detrimental pests and pathogens which are largely found in your plant's root zone. Used to protect the roots in farming, horticulture, gardening, and many other capacities, Growers Trust Root Cleaner.



8oz
CCG2008
UPC 083832041717
Min Buy 15 EA

32oz
CCG2032
UPC 083832041816
Min Buy 4 EA



1gal
CCG2128
UPC 083832041915
Min Buy 4 EA



Insecticides & Miticides

Central Coast Garden Products Green Cleaner

Green Cleaner kills broad mites, russet mites, spider mites and their eggs, aphids, thrips, white flies and powdery mildew on contact. Green Cleaner is 100 percent concentrate product and can be used as a solution to dip tender new cuttings in, to prevent garden contamination when outsourcing plant starts, and can be used from start through harvest as a treatment. We start with soybean oil and sodium lauryl sulfate. The soybean oil acts to quickly suffocate pests, such as spider mites, broad mites, and russet mites, while the sodium lauryl sulfate coats bugs to immobilize them.



2oz
CCG1002
UPC 696859950681
Min Buy 40 EA

8oz
CCG1008
UPC 696859950704
Min Buy 15 EA

32oz
CCG1032
UPC 696859950711
Min Buy 4 EA

1gal
CCG1128
UPC 696859950728
Min Buy 1 EA

2.5gal
CCG1320
UPC 653341164445
Min Buy 2 EA





Fungicides & Bactericides

Bonide® Copper Octanoate Fungicide

A natural copper formulations that protect everything from turf, to vegetables, to fruit and flowers. All are approved for organic gardening. Not for sale in AK, CA. Active: Copper Octanoate

ACTIVE INGREDIENT Copper Octanoate



16oz Concentrate

BND811

UPC 037321008118

Min Buy 12 EA

32oz Ready to Use with Trigger Sprayer

BND775

UPC 037321007753

Min Buy 12 EA



Bonide® Sulfur Plant Fungicide

Sulfur 90%. A specially prepared micronized sulfur suitable for use as a dust or spray. The fine particle size gives better coverage, adhesion and disease control. This product controls a large number of diseases on fruits, vegetables and various ornamentals. Approved for organic gardening. Now labeled for chiggers. Not for sale in AK.

ACTIVE INGREDIENT Sulfur 90%



4lb Dust (Can Use as Dust or Spray)

BND142

UPC 037321001423

Min Buy 12 EA



Other

Bonide® Measuring Cups

Calibrated for teaspoon, tablespoon and ounces. Provides a good alternative to using kitchen measuring devices for pesticides.



4oz Cup

BND050

UPC 037321000501

Min Buy 24 EA



Insecticides & Miticides

Bonide® Captain Jack's Deadbug Brew®

Contains Spinosad. Kills bagworms, borers, beetles, caterpillars, codling moth, gypsy moth, loopers, leaf miners, spider mites, tent caterpillars, thrips and more. Not for sale in AK and HI.

ACTIVE INGREDIENT Spinosad



16oz Concentrate

BND252

UPC 037321002529

Min Buy 12 EA

32oz Concentrate

BND253

UPC 037321002536

Min Buy 12 EA

32oz Ready to Use with Trigger Sprayer

BND250

UPC 037321002505

Min Buy 12 EA



Bonide® Diatomaceous Earth Crawling Insect Killer

Full strength DE for indoor/outdoor insect control in homes, barns, stables, vegetable and flower gardens. This mechanical mode of action works by contact and by ingestion. Insects cannot become immune to its action. Insects all succumb within 24-48 hours of contact. Apply as a dust or a slurry. All natural and earthworm safe.



5lb Bag

BND121

UPC 037321001218

Min Buy 8 EA



Bonide® Neem Oil Insecticide

An all purpose insecticide, miticide, fungicide for organic gardening. Derived from the Neem seed. Use on roses, flowers, vegetables, herbs, spices, houseplants, trees, turf and shrubs. Kills all stages of insects – eggs, larvae and adults. Makes a great dormant spray.

ACTIVE INGREDIENT Neem



16oz Concentrate

BND024

UPC 037321000242

Min Buy 12 EA

32oz Ready to Use with Trigger Sprayer

BND022

UPC 037321000228

Min Buy 12 EA



Bonide® Pyrethrin Garden Insect Spray

Natural Pyrethrin in a concentrated formula for economical, natural, broad spectrum garden insect control. Ideal for vegetables, fruits, flowers and delicate ornamentals. Use up to day of harvest. Not for sale in CA.

ACTIVE INGREDIENT Pyrethrin



8oz Concentrate

BND857

UPC 037321008576

Min Buy 12 EA

16oz Concentrate

BND858

UPC 037321008583

Min Buy 12 EA





Insecticides & Miticides

Conserve® SC Insecticide

A turf and ornamental insect control with a unique mode of action derived from a naturally occurring organism. Makes a great rotational insecticide and is highly active at very low use rates. Great for control of thrips and lepidopterans larvae on herbaceous and woody ornamentals grown outdoors, in nurseries or in greenhouses; tree farms or plantations; and turf grass.

ACTIVE INGREDIENT Spinosad



32oz

DOW19-0007Z

Min Buy 1 QT



Insecticides & Miticides

DYNA-GRO® Neem Seed Meal Organic Fertilizer 4-1-1

Neem Seed is the by-product of cold pressing the seed of the neem tree for its oil. What is left after extracting the oil is an excellent organic fertilizer with high N-P-K values and slow release properties. It contains more nitrogen, phosphorus, potassium, calcium and magnesium than manure or sewage sludge, and provides a variety of benefits to plants and the growing medium. OMRI Listed.



20kg

DYNNM020

UPC 080359190201

Min Buy 1 EA



Fungicides & Bactericides

Eagle® 20EW Fungicide

Systemic protectant fungicide for use on ornamentals in greenhouses, nurseries and landscapes as well as turf and golf applications. Controls key diseases like powdery mildew, rust, scab and anthracnose.

ACTIVE INGREDIENT Myclobutanil



16oz

DOW173917

Min Buy 1 PT

1gal

DOW19-2505B

Min Buy 1 GL



DYNA-GRO® Pure Neem Oil Organic Leaf Polish

100% pure cold pressed Neem oil. Neem oil leaves a natural shine on leaves without clogging stomata that leaves need to take in carbon dioxide and release oxygen.



8oz

DYNNEM008

UPC 080359150083

Min Buy 12 EA

32oz

DYNNEM032

UPC 080359150328

Min Buy 12 EA

1gal

DYNNEM100

UPC 080359151004

Min Buy 4 EA

5gal

DYNNEM500

UPC 080359155002

Min Buy 1 EA

55gal

DYNNEM550

UPC 080359155507

Min Buy 1 EA



DRAMM

Other

Dramm® PulsFOG® Cleaning Solution PFC

Cleaning solution for Dramm fogging equipment.



1gal

DRMPFC1

Min Buy 1 EA





Other

Piccolo® Plant Growth Regulator

Brings out the best in ornamentals by producing compact, consistent quality plants. By delivering outstanding height and radius control, Piccolo enhances the quality of bedding plants, flowering and foliage crops, bulb crops, perennials and woody ornamentals, making them easier to market and more profitable to produce. As a spray or drench, Piccolo has been proven in dozens of university trials and ranks among the most popular PGRs among quality-minded growers.

ACTIVE INGREDIENT paclobutrazol



1 gal
FINE190636
Min Buy 1 BT



Piccolo® 10XC Plant Growth Regulator

Brings out the best in ornamentals by producing compact, consistent quality plants. By delivering outstanding height and radius control, Piccolo enhances the quality of bedding plants, flowering and foliage crops, bulb crops, perennials and woody ornamentals, making them easier to market and more profitable to produce. As a spray or drench, Piccolo has been proven in dozens of university trials and ranks among the most popular PGRs among quality-minded growers. Plus, one quart of Piccolo 10 XC equals 2.5 gallons of regular Piccolo.

ACTIVE INGREDIENT paclobutrazol



32oz
FINE19-0636E
Min Buy 1 QT



Fungicides & Bactericides

JH Biotech Fosphite®

For control of Phytophthora, Pythium, and Downy Mildew on food crops, turf, and ornamentals. Fosphite® is an effective systemic fungicide. It has been approved by the EPA as a 'Reduced Risk Pesticide' for control of Phytophthora, Pythium, and Downy Mildew on food crops, ornamentals and bedding plants, Phytophthora in conifers and Pythium in turf.



2.5gal
JH011005
Min Buy 1 BT



Insecticides & Miticides

Aza-Direct® Biological Insecticide

Aza-Direct is a broad spectrum biological insecticide that controls key insect pests on greenhouse and outdoor food crops, ornamental plants and shrubs and nursery crops. Its primary mode of action is as an insect growth regulator which inhibits molting and the development of immature insects into healthy adults. Effective repellent and antifeedant thereby affecting both immature and adult insect pests.

ACTIVE INGREDIENT Azadirachtin



2.5gal
GOW14022
Min Buy 1 BT



Captiva Prime® Botanical Insecticide

Captiva Prime botanical insecticide agitates Mites and Thrips, flushing them from cover and enhancing contact with the pest. Captiva® Prime can be used as a stand-alone product to repel thrips and mites, stop their feeding and inhibit ovipositing. When used as a tank mix partner with traditional insecticides, it will enhance their activity.

ACTIVE INGREDIENT Capsicum extract, Garlic Oil, Canola Oil



32oz
GOW65700
Min Buy 1 QT



M-Pede® Insecticide / Miticide / Fungicide

Natural, safe, insecticide, miticide and fungicide that provides excellent contact control of various soft bodied insects, mites and powdery mildew throughout their life cycles.

ACTIVE INGREDIENT Potassium Salts of Fatty Acids



2.5gal
GOW52822
UPC 051538405485
Min Buy 1 BT





Insecticides & Miticides

Monterey® Garden Insect Spray

Can be used on outdoor ornamentals, lawns, vegetables, fruit trees, etc. to control caterpillars, leaf miners, codling moth, tent caterpillars, gypsy moth, thrips, borers and more. Also used to control fire ants in lawns and other outdoor areas. Contains Spinosad. Fast acting and odorless. OMRI listed for organic gardening.

ACTIVE INGREDIENT Spinosad



8oz Concentrate
MLGNLG6158
UPC 022179104730
Min Buy 12 EA

32oz Ready to Spray with Hose End Sprayer
MLGNLG6138
UPC 022179102958
Min Buy 12 EA

16oz Concentrate
MLGNLG6150
UPC 022179101630
Min Buy 12 EA

32oz Ready to Use with Trigger Sprayer
MLGNLG6133
UPC 022179104341
Min Buy 12 EA

32oz Concentrate
MLGNLG6135
UPC 022179102446
Min Buy 12 EA

1gal Concentrate
MLGNLG6155
UPC 022179102392
Min Buy 4 EA



Monterey® Azera® Organic Insect Control

Kills insect through contact or by ingestion. Contains Pyrethrins, a botanical insecticide derived from Chrysanthemums. Quick knockdown and kill of larvai, pupae and adult stages of listed insects. For use on ornamentals and in the greenhouse. OMRI listed for organic gardening.

ACTIVE INGREDIENT Pyrethrins



8oz Concentrate / Makes up to 16 Gallons
MLGNLG6257
UPC 848920000805
Min Buy 1 EA

32oz Concentrate
MLGNLG6267
UPC 848920000683
Min Buy 6 EA



Monterey® Bug Buster-O

OMRI Listed for organic gardening. Provides rapid knockdown & kill of listed plant pests. Can be used on day of harvest. Kills more than 100 listed insects

ACTIVE INGREDIENT Pyrethrins



1pt
MLGNLG6396
UPC 022179104228
Min Buy 6 EA



Monterey® Sluggo®

Kills snails and slugs. OMRI® listed for organic gardening. Can be used around pets and wildlife. Remains effective after rain or sprinkling. Can be used in vegetable gardens up until the day of harvest. Easy to use pellet formulation. Contains Iron Phosphate. 1lb covers 2,000sq ft.

ACTIVE INGREDIENT Iron Phosphate



1lb Shaker Can
MLGNLG6515
UPC 022179101241
Min Buy 12 EA

5lb Jug
MLGNLG6530
UPC 022179101579
Min Buy 6 EA

2.5lb Jug
MLGNLG6500
UPC 022179101852
Min Buy 6 EA



Monterey® Sluggo® Plus

Kills slugs and snails plus sow bugs, pill bugs, earwigs and cutworms. OMRI® listed for organic gardening. Contains Iron Phosphate and Spinosad. Can be used in vegetable gardens up until day of harvest. Easy to use pellet formulation. 1lb covers 1,000sq ft.

ACTIVE INGREDIENT Iron Phosphate, Spinosad



1lb Shaker Can
MLGNLG6575
UPC 022179102484
Min Buy 12 EA



Monterey® Once a Year Insect Control II

Easy to use – Mix in water and pour around trees or shrubs. Controls emerald ash borers. Kills insects and prevents new infestations. Systemic insecticide is absorbed through the roots, carried up into the plant, and can't wash off!

ACTIVE INGREDIENT 1.47% Imidacloprid



1gal
MLGNLG6350
UPC 022179102637
Min Buy 4 EA



Monterey® Horticultural Oil Fungicide, Insecticide & Miticide

Year round usage, can be used in dormant and growing season. Is a natural insecticide for control of aphids, mites, scale, whiteflies and other soft bodied insects. OMRI listed for organic gardening.



32oz Ready to Use with Trigger Sprayer
MLGNLG6302
UPC 022179104907
Min Buy 12 EA





Insecticides & Miticides

Monterey® Horticultural Oil

OMRI listed for organic gardening. For use on ornamentals, roses, vegetables, citrus, small fruits, tree fruits and nuts. Controls aphids, mites, scales, whiteflies and other soft-bodied insects.



32oz - Ready to Use with Trigger Sprayer

MLGNLG6290

UPC 022179103757

Min Buy 12 EA

1gal

MLGNLG6292

UPC 022179103764

Min Buy 4 EA



Fungicides & Bactericides

Monterey® 70% Neem Oil Insecticide

A broad spectrum insecticide, miticide and fungicide that controls numerous diseases as well as insects and mites. For use on vegetables, fruit trees, ornamentals and more. OMRI™ listed for organic gardening. A high grade neem oil that does not gel.

ACTIVE INGREDIENT 70% Neem



8oz

MLGNLG6128

UPC 022179104716

Min Buy 12 EA

16oz

MLGNLG6127

UPC 022179101678

Min Buy 6 EA

32oz Ready to Use with Trigger Sprayer

MLGNLG6148

UPC 022179103276

Min Buy 12 EA

1gal

MLGNLG6142

UPC 022179104174

Min Buy 4 EA



Other

Monterey® Florel® Plant Growth Regulator

Prevents fruit formation on apple, cottonwood, crabapple, elm, flowering pear and many more trees. Just one application in the spring during full bloom controls the mess.



32oz Concentrate

MLGNLG4105

UPC 022179101340

Min Buy 1 EA



Monterey Liqui-Cop® Copper Fungicidal Garden Spray

Disease prevention for fruit trees, nut crops, citrus, vegetables and ornamentals.



32oz Ready to Spray

MLGNLG3190

UPC 022179102576

Min Buy 12 EA



Monterey® Complete Disease Control

Biofungicide and bactericide. OMRI listed for organic gardening. Can be used as a foliar spray or as a soil drench. For use in indoor gardening, vegetables, ornamental and fruit trees, shrubs, lawns, bedding plants and potted plants. Controls powdery mildew, botrytis, early and late blight, fire blight, fusarium, Pythium and other diseases. Colonizes roots to prevent diseases.

ACTIVE INGREDIENT Beneficial Bacterium Bacillus Amylolyquefaciens



16oz Concentrate

MLGNLG3374

UPC 022179104440

Min Buy 6 EA

1gal Concentrate

MLGNLG3382

UPC 022179104471

Min Buy 4 EA

32oz Ready to Use with Trigger Sprayer

MLGNLG3174

UPC 022179104488

Min Buy 12 EA



Biologicals

Monterey® BT Biological Insecticide

Controls worms and caterpillars on fruits, vegetables, ornamentals and shade trees. OMRI listed for organic gardening. Can be used on edible plants up to the day of harvest.

ACTIVE INGREDIENT Bacillus thuringiensis subspecies kurstaki strain SA-12



16oz Concentrate

MLGNLG6332

UPC 022179103900

Min Buy 12 EA

32oz Ready to Use with Trigger Sprayer

MLGNLG6338

UPC 022179104082

Min Buy 12 EA



32oz Concentrate

MLGNLG6336

UPC 022179103917

Min Buy 12 EA

1gal Concentrate

MLGNLG6344

UPC 022179104068

Min Buy 4 EA

Monterey® Liquid Copper Soap Fungicide RTU

OMRI listed for organic gardening. Dormant and growing season fungicide for flowers, fruits & vegetables. Use in homes, home gardens and home greenhouses. Can be used up to day of harvest. Controls listed plant diseases: Powdery Mildew, Rusts, Black Spot, Leaf & Fruit Spot, Downy Mildew, Fruit Rot, Late Blight, Leaf Curl.



32oz Ready to Use with Trigger Sprayer

MLGNLG3154

UPC 022179104617

Min Buy 12 EA





Biologicals

Orcon Cryptolaemus

Cryptolaemus are often called "Mealybug Destroyers" because of their voracious appetite for Mealybugs! They look like small ladybugs with an orange head and tail and a black body. Their first choice is Mealybugs, but they also eat aphids, immature scale and immature whitefly.



25 Adults Per Container

ORCCMERT

UPC 045501063130

Min Buy 5 EA



Orcon Delphastus

Delphastus is a small, shiny, black beetle, about one quarter the size of a ladybug, which feeds on several species of whitefly including greenhouse, sweet potato (silverleaf) and avocado whitefly. If whitefly are not present they will feed on spider mites. Both the adult beetle and larvae are predators and will eat whitefly eggs and larvae, but not adult whiteflies.



25 Adults Per Container

ORCDPCERT

UPC 045501063116

Min Buy 5 EA



Orcon Encarsia Formosa

This is a parasite of the greenhouse whitefly, *Trialeurodes vaporariorum*, a pest of many plants in interior plantscapes and outdoor gardens. Greenhouse whiteflies are typically found on poinsettias, tomatoes, peppers, cucumbers and other plants that stay fairly close to the ground.



1,000 Eggs Per Container

ORCEFCERT

UPC 045501064113

Min Buy 5 EA



Orcon fly Parasites

Flies are so difficult to control because they are so prolific. Flies reproduce so rapidly, chemicals have never been successful in controlling fly populations because they can mutate and produce pesticide-resistant offspring. Fly Parasites interrupt these prolific insects' life cycle, breaking the chain.



5,000 Eggs Per Container

ORCFPCERT

UPC 045501068159

Min Buy 5 EA



Orcon Green Lacewings

The natural enemy of many species of pests, insects and mites, the Green Lacewings are shipped as eggs that will soon hatch into larvae. The tiny larvae are known as "Aphid Lions" because of their voracious appetites (devouring as many as 1,000 aphids per day). They remain as larvae for up to 21 days, just crawling around looking for food. Aphid Lions also make hearty meals of Mealybugs, spider mites, caterpillars, thrips, leaf hoppers, whitefly larvae, a wide variety of moth eggs and just about any other soft-bodied pests. The adult only feeds on pollen, but it will immediately begin laying eggs, and the life cycle will repeat.



1,000 Eggs Per Container

ORGLCERT

UPC 045501061112

Min Buy 5 EA



Orcon Ladybugs

A favorite "good bug" and alternative to chemicals. When released at sundown (because they don't fly at night), ladybugs eat aphids, mealy bugs, scale, leaf hoppers, various plant-eating worms and other destructive soft-bodied pests. They keep on eating until the bad guys are gone, laying their own eggs in the process. When new pests arrive, fresh ladybugs will be waiting.



500 Per Container

ORCLBR500

UPC 045501011018

Min Buy 24 EA



Orcon Trichogamma

An effective destroyer of caterpillars (which are leaf eaters in the larvae stage) and moth eggs. Some of the moth eggs attacked by the Trichogamma are: bollworms, tobacco budworm, codling moth, corn earworm, alfalfa caterpillar, gypsy moth, cutworm and tomato hornworms. They are tiny parasites that lay their eggs inside the caterpillar or moth eggs. They hatch and feed on the pest eggs, killing them. Then they emerge as adults to continue the cycle.



10,000 Eggs Per Container

ORCTRCERT

UPC 045501062317

Min Buy 5 EA



ORGANOCIDE

Fungicides & Bactericides

Plant Doctor® Systemic Fungicide

An earth-friendly broad spectrum disease control and preventative for use on turf, fruit trees, vegetables, ornamentals and flowers. Controls and prevents a myriad of plant diseases including those that cause root rot, leaf and stem blights, leaf spots and more as listed! A systemic product, it has a foliar or root application that will work its way throughout the entire plant to prevent disease and attack existing disease above and below ground. Once inside the plant, Plant Doctor® increases plant metabolism so plants grow faster, bloom more and have an increased yield while providing a nutritional boost of potassium and phosphorus, essential nutrients for plant growth.



32oz Concentrate

ORG810021

UPC 679045339583

Min Buy 12 EA



Insecticides & Miticides

ORGANOCIDE® Bee Safe 3-in-1 Garden Spray

OMRI listed Insecticide, Fungicide & Miticide. It kills the eggs, larvae, nymphs and adults, of over 25 small soft bodied insects & mites and certain fungal diseases such as powdery mildew. The dense oils suffocate insects by contact, so insects can't develop a resistance. Leaves a micro-film on the plant which repels egg-laying females. Will not harm beneficial insects such as bees, lady bugs or butterflies. Can be sprayed at harvest time. Use in organic gardening on vegetables, fruits, nuts, vine crops, herbs, ornamentals, greenhouse crops, turf grass, landscape plants, bulbs, flowers and field crops. People, planet and pet friendly!



24oz Ready to Use with Trigger Sprayer

ORG100004

UPC 679045119697

Min Buy 12 EA

32oz Concentrate

ORG100021

UPC 679045119581

Min Buy 12 EA



PACE 49 Inc.

Sanitizers, Cleaners, Disinfectants

KleenGrow™ Disinfectant / Bactericide / Algacide / Fungicide

KleenGrow™ is an EPA registered, unique, biodegradable, 4th generation DDAC quaternary ammonium which provides curative and preventative broad - spectrum control of algae, fungus, and bacteria on greenhouse flowers and ornamentals. KleenGrow can safely be applied as a spray, drench, or drip on crops, from propagation, bulbs/seeds, to finished crops, while offering residual disease control by way of membrane disruption with no worry of crop resistance. KleenGrow can also be used to control algae, bacteria, and viruses on hard surfaces. Product can safely be used to disinfect greenhouse structures, floors, benches, cool pads, irrigation lines, plastic pots/trays, tools, coolers, and in footbaths to reduce the spread of algae and diseases.

ACTIVE INGREDIENT Didecylidimethyl ammonium chloride



5gal

PAC4919-0603J

Min Buy 1 BT

30gal Drum

PAC4919-0603K

Min Buy 1 DR



Horti-Klor™

HORTI-KLOR™ is a heavy-duty detergent that is formulated for cleaning and sanitizing throughout the food plant and grower industries. Can safely be used to clean indoor growing facilities, packing houses and coolers. HORTI-KLOR™ is an active, high-foaming detergent designed to help meet the highest food plant and greenhouse grower sanitation standards and is HACCP approved. Thorough rinse required.

ACTIVE INGREDIENT Sodium Hydroxide



55gal

PAC4919-0604C

Min Buy 1 DR



STRIP-IT PRO™

STRIP-IT PRO™ is a powerful combination of cleaning and wetting agents that effectively remove whitewash coatings, algae, dirt and mineral deposits including calcium due to hard water issues. Safely removes all common soils found in and around greenhouses, grower structures during crop rotation. Unlike other cleaning products, STRIP-IT PRO™ will not harm the greenhouse structure and can safely be used to clean under benches with no harmful fumes to effect plants. Thorough rinse required.

ACTIVE INGREDIENT Sulfuric Acid, Ammonium Bifluoride



5gal

PAC4919-0603D

UPC 073095061607

Min Buy 1 BT





Animal Repellents

PyGanic® Gardening Organic Insect Control

Pyganic Gardening is a botanical insecticide designed for the home gardener. Pyganic rapidly knocks down and kills the most damaging garden pests. Labeled for use on vegetables, herbs, fruit and nut trees, and ornamental plants grown in gardens.



8oz
MGK7443G20
UPC 084892000706
Min Buy 1 EA

32oz
MGK7448AD30B
UPC 084892000713
Min Buy 1 EA



Actinovate® SP Biological Fungicide

Actinovate® SP Biological Fungicide suppresses and controls root rot, damping-off fungi and foliar fungal pathogens. When used as a soil drench, it also suppresses and controls soil-borne fungi.

ACTIVE INGREDIENT Streptomyces lydicus



18oz
NOVZ5000-725
Min Buy 1 BG



PyGanic® Specialty Insecticide

Pyganic Specialty is a professional botanical insecticide that rapidly knocks down and kills pests in greenhouses and nurseries. Labeled for use on ornamental plants, vegetables, fruit and nut trees.

ACTIVE INGREDIENT Pyrethrins (5.0 EC)



1qt
MGK7444-D30A
Min Buy 1 QT

1gal
MGK19-0545M
Min Buy 1 BT



Insecticides & Miticides

Evergreen® Pro 60-6

Evergreen® Pro 60-6 is a botanical based multi-purpose insecticide for use on growing crops, ornamentals, stored products, and harvested fruits and vegetables. Can be also used as a water system treatment for hydroponically grown vegetables.



32oz
MAAS1750204QT
UPC
Min Buy 1 QT

1 Gallon
MAAS1750204012
UPC
Min Buy 1 BT



ProKure®

Fungicides & Bactericides

ProKure® V

ProKure V liquid is EPA-registered hospital-type disinfectant and deodorizer. Water-activated (ships dry). It destroys bacteria, viruses*, mold, fungi, and odor-causing bacteria. EPA List N product. Suitable for use with plants in the room. *See EPA label for claims.

ACTIVE INGREDIENT Sodium Chlorite



.042oz Packet
CLR0042C12
Min Buy 12 EA

.84oz Packet
CLR084C12
Min Buy 12 EA

.17oz Packet
CLR017C12
Min Buy 12 EA

3.36oz Packet
CLR336C12
Min Buy 12 EA



SANCO INDUSTRIES, INC.

Fungicides & Bactericides

Sanco® 100% Cold Pressed Orange Oil

This product is 100% cold pressed orange oil and is also known as D-Limonene. Orange Oil is a great alternative to harsh chemicals and is often used for an all-purpose cleaner and air freshener. This food grade product is derived from the citrus peel of oranges and is a common ingredient in perfume blends and household cleaners. D-limonene is designed to be used as an industrial cleaner and/or hard surface cleaner for difficult to remove grime.

It can also be used to make formulated products for applications such as laundry, adhesive removal, or waterless hand cleaner.



16oz Bottle
SAN02072
UPC 768980020720
Min Buy 12 EA



Sanco® Natural Vinegar (30%)

Concentrated vinegar can be used for many household solutions. There are hundreds of recipes for cleaning, laundry and automotive. Use caution when using concentrated vinegar. Excellent for removing mildew and grime, simply wipe with undiluted vinegar and rinse with water.



1gal
SAN88008
UPC 768980880080
Min Buy 4 EA





Insecticides & Miticides

St Gabriel Organics® GoodEarth Food Grade Diatomaceous Earth

Consists of 100% food grade diatomaceous earth. OMRI™ listed for use in organic production. Safe for use in all animal feed including dogs and cats. Used as an anti-caking agent in stored grains including bird food.

ACTIVE INGREDIENT Food grade Diatomaceous Earth



4lb Bag
SGL501020
 UPC 699064501020
 Min Buy 6 EA



St Gabriel Organics® Insect Dust - Diatomaceous Earth - Flea & Tick

Kills all crawling insects such as fleas, cockroaches, ants, millipedes, centipedes and crickets. Can be used indoors or outdoors. Apply lightly and uniformly as a barrier around foundations, patios, porches and pools. Use indoors in kitchen, corners, under appliances and behind baseboards. Also for use outdoors: dust around patios, window sills and door frames, along ant trails and sewer pipes and foundations. 100% food grade diatomaceous earth.

ACTIVE INGREDIENT Food grade Diatomaceous Earth



4.4lb Ready to Use Dust
SGL500207
 UPC 699064500207
 Min Buy 6 EA



Insecticides & Miticides

Summit® Mosquito Dunks®

Kills mosquito larvae in standing water for 30 days or longer. Made with BTi, a natural soil borne bacteria, contains no poisonous chemicals. Harmless to other living things. Simply place a Mosquito Dunk® in areas where water collects around your home. Perfect for Koi ponds, hydroponic systems, rain barrels, stock tanks, etc. Each Dunk® treats up to 1,000sq ft of water surface regardless of depth.

ACTIVE INGREDIENT Bacillus thuringiensis subspecies israelensis



6 per Card
MSD11012
 UPC 018506001100
 Min Buy 12 EA



Summit® Quick Kill Mosquito Bits™

Apply to any standing water to eliminate mosquito larvae within 24 hours. Contains BTi; harmless to people, plants & pets. Break fungus gnat life cycle by using in growing media or soil of houseplants, garden & landscape plants and mushroom beds. Biological fungus gnat control that really works!

ACTIVE INGREDIENT Bacillus thuringiensis subspecies israelensis



8oz - Covers up to 2,000sq ft	20lb - Covers up to 1.8 acres
MSD11612	MSD1191
UPC 018506001162	UPC 018506001193
Min Buy 12 EA	Min Buy 1 EA
30oz - Covers up to 7,500sq ft	
MSD1176	
UPC 018506001179	
Min Buy 6 EA	



Biologicals

TetraCURB™ Concentrate Miticide-Insecticide

Kills and repels mites and small soft-bodied insects such as two-spotted spider mites, aphids, whiteflies, thrips, lygus or mealybugs. Labeled for use on all crops. Controls all pest life stages. Emulsifiable concentrate, smart blend of soap and emulsifier for greater spread, efficacy and minimal phytotoxicity. Recommended application rate: 64 fl. oz./100 gal water. Foliar spray.

ACTIVE INGREDIENT Rosemary Oil



1gal
KEM018139GL
 Min Buy 1 GL



Biologicals

Spear-T® Insecticide / Miticide

Spear-T® Liquid Concentrate is a biological insecticide/miticide for treatment of thrips, whiteflies, two spotted spider mites, broad mites and aphids in vegetables in greenhouses. It features a new mode of action, environmentally friendly, safe for honeybees. Can be sprayed or fogged, labeled for greenhouse use only.

ACTIVE INGREDIENT GS-omega/kappa-Hxtx-Hv1a



1gal
VESBT128
 Min Buy 1 GL





Fungicides & Bactericides

Grower's Ally® Fungicide

Formulated with food-grade citric acid, Grower's Ally is proven to kill and prevent common plant pathogens, including powdery mildew. Trusted by large scale growers for use in the vegetative and flowering stages, Grower's Ally tests clean and provides crop protection up to the day of harvest.

ACTIVE INGREDIENT Citric Acid 1.07%



8oz Concentrate
SGG10269
 UPC 810021610269
 Min Buy 8 EA

1gal Concentrate
SGG10047
 UPC 810021610047
 Min Buy 4 EA

24oz Ready To Use
SGG10023
 UPC 810021610023
 Min Buy 6 EA

2.5gal Concentrate
SGG10146
 UPC 810021610146
 Min Buy 2 EA



Insecticides & Miticides

Grower's Ally® Spider Mite Control

Proven to kill and repel spider mites, russet mites and thrips, Grower's Ally knocks down common pests with a synergistic blend of essential oils. Soft-bodied insects are paralyzed and suffocated by the highly effective formulation that contains no alcohols or heavy oils.

ACTIVE INGREDIENT Rosemary Oil 50% Clove Oil 3% Peppermint Oil 1.95%



8oz Concentrate
SGG10276
 UPC 810021610276
 Min Buy 8 EA

1gal Concentrate
SGG10085
 UPC 810021610085
 Min Buy 4 EA

24oz Ready To Use
SGG10061
 UPC 810021610061
 Min Buy 6 EA

2.5gal Concentrate
SGG10153
 UPC 810021610153
 Min Buy 2 EA



32oz Concentrate
SGG10078
 UPC 810021610078
 Min Buy 6 EA



Insecticides & Miticides

BioAdvanced® Fruit, Citrus & Vegetable Insect Control

Season-long protection without spraying, just mix and pour. Kills insects and prevents new infestations. Specially formulated for use on 100+ fruits, vegetables and citrus plants. Rainproof protection won't wash off. Active: 0.235% Imidacloprid. Treats up to 640sq ft of vegetables OR up to nine fruit trees. Not for sale, sale into, distribution, and or use in Nassau, Suffolk, Kings and Queens counties of NY. Reclassified as restricted us in CT, MD & VT.

ACTIVE INGREDIENT 0.235% Imidacloprid



32oz Concentrate
BAY701520A
 UPC 687073015201
 Min Buy 8 EA



Insecticides & Miticides

GreenGro™ Pride Lands Defense Pest Preventative

A unique blend of nutritive soil amendments and pest repellent - organic herbs and spices used to give growers long lasting pest prevention as well as condition the soil prior to planting.



2lb
GGBPLD0002
 UPC 857834003789
 Min Buy 10 EA

25lb
GGBPLD0025
 UPC 857834003482
 Min Buy 1 EA

5lb
GGBPLD0005
 UPC 857834003468
 Min Buy 8 EA

250lb
GGBPLD0250
 UPC 857834003598
 Min Buy 1 EA



10lb
GGBPLD0010
 UPC 857834003475
 Min Buy 4 EA



Biologicals

Enviro Pot Popper Organic Gnat Control

Slowly releases nematodes into the soil for long-lasting control. For usage in indoor, greenhouse, and hydroponic applications. Outdoors in containers and gardens. 100% Pesticide free.



EFI4004220
 UPC 817504004225
 Min Buy 12 EA



Nema Globe™ Grub Busters™ Grub Eliminator

The Nema Globe biological Grub Buster product is encapsulated in a proprietary gel formulation. The exclusive organic pet safe formula rids your yard of grubs, weevils and fungus gnats.



Covers 2,000sqft
EFI4003000
 UPC 817504003013
 Min Buy 12 EA



NemaKnights™ Nematodes Fungus Gnats And Thrips

Extended slow release to control of larval soil pests. Easy application; simply flip lid and shake in the area with pests. For use indoors and outdoors.



10oz
EFI4004420
 UPC 817504004423
 Min Buy 12 EA



Herbicides

Green It™ Corn Gluten Weed Preventer™

Ready to spray liquid Weed Preventer. Stops weeds before sprouting. Liquid formula corn gluten comes ready to spray.



Ready to Spray - 64oz
EFI4002708
 UPC 817504002719
 Min Buy 6 EA



Insecticides & Miticides

Enviro Long Lasting Sticky Traps

Sticky trap effectively catches Gnats, aphids, thrips and more. For use as a standalone fly trap or in potted plants. Works great in gardens, greenhouses or indoor potted plants.



10/pk
EFI4003302
 UPC 817504003310
 Min Buy 12 EA



Other

Environmental Factor JetEye Pest Repeller

The JetEye Animal Repeller is the automated solar powered solution to scare off cats, dogs, and wild animals, such as raccoons, squirrels, skunks, etc. in a humane way from protected areas using a simple water jet process.



EFI4007010
 UPC 817504007103
 Min Buy 12 EA





Fungicides & Bactericides

Safer® Brand Garden Fungicide

Controls and prevents black spot, rust, leaf spot and powdery mildew on roses. Contains sulfur, a natural element which is toxic to fungus.

ACTIVE INGREDIENT Sulfur



16oz Concentrate

WOD54566

UPC 024654554566

Min Buy 6 EA

32oz Ready to Use

WOD54506

UPC 024654554504

Min Buy 6 EA



Insecticides & Miticides

Safer® Brand Insect Killing Soap

Safer® Brand Insect Killing Soap Concentrate eliminates insect pests so your garden plants can grow healthy and strong. This special formulation of insecticidal soap and seaweed extract kills soft-bodied insects while remaining gentle enough to spray directly on your plants. Safer® Brand Insect Killing Soap has no unpleasant odor, so you can still enjoy the natural aromas of your garden. Most importantly, this OMRI Listed® insect killer is compliant for use in organic gardening so you can stay true to your plans for growing your fruits, vegetables and flowers.



16oz Concentrate

WOD51186

UPC 024654551183

Min Buy 6 EA

32oz Ready to Use

WOD51106

UPC 024654551107

Min Buy 6 EA



Safer® Brands 3-in-1 Garden Spray

Unique formulation combining effectiveness of insecticidal soap with sulfur based fungicide. Multipurpose formulation which controls mites, insects and fungus. Does not harm beneficial insects. Organic formulation ideal for use around children, pets and wildlife. OMRI listed for organic gardening.

ACTIVE INGREDIENT potassium salts of fatty acids (12.38%) and sulfur (6.48%)



32oz Concentrate

WOD54624

UPC 024654054622

Min Buy 4 EA

1gal Concentrate

WOD5462GAL

UPC 024654010611

Min Buy 4 EA



Insecticides & Miticides

Safer® Brand 3-in-1 Garden Spray

Unique formulation combining effectiveness of insecticidal soap with sulfur based fungicide. Multipurpose formulation which controls mites, insects and fungus. Does not harm beneficial insects. Organic formulation ideal for use around children, pets and wildlife. OMRI listed for organic gardening.

ACTIVE INGREDIENT potassium salts of fatty acids (.75%) and sulfur (.4%)



32oz Ready to Use

WOD54526

UPC 024654654525

Min Buy 6 EA



Safer® Brand Diatomaceous Earth - Bed Bug, Flea, Ant, Crawling Insect Killer

Safer® Brand Diatomaceous Earth (D.E.) provides pest control against a variety of crawling insects. This ready-to-use powder-like insecticide is super easy to use and can be applied to places where insects spend most of their time. Once insects come in contact or ingest this dual-action powder, it immediately goes to work to completely kill them within 48 hours. This D.E. is non-staining and has no odor, so you can confidently apply within your home. D.E. also works outdoors to eliminate pesky crawling insects as they try to sneak inside your home. Just keep in mind that it will need to be reapplied after watering or rain.



4lb

WOD51703

UPC 038241517032

Min Buy 4 EA



Safer® Brand End ALL® Insect Killer with Neem Oil

Safer® Brand End All® insect killer eliminates 45 listed soft- and hard-bodied insects, including stink bugs, at any stage of their lifecycle. Safer® Brand End ALL® is best used on ornamentals, trees, shrubs, fruits, vegetables, flowers and houseplants providing you with a large variety of applications. End ALL® breaks down into its natural state within seven to ten days, and does not persist in the environment.

ACTIVE INGREDIENT Potassium Salts of Fatty Acids 1.0%, Clarified Hydrophobic Extract of Neem Oil 0.9%



32oz Ready to Use with Trigger Sprayer

WOD51026

UPC 024654051027

Min Buy 6 EA



Safer® Diatomaceous Earth

Safer® Brand offers insect control solutions containing a potent diatomaceous earth formula that can kill crawling bugs within 48 hours! DE is an OMRI Listed® substance consisting of crushed fossilized algae known as diatoms. It kills insects by cutting through their exoskeletons, resulting in a quick death by dehydration. Safer Brand® Diatomaceous Earth is compliant for use in organic production.



4lbs

WOD51704

UPC 024654517042

Min Buy 4 EA





Insecticides & Miticides

Bonzi® Plant Growth Regulator

The leading ornamental plant growth regulator (PGR), Bonzi® keeps plants uniformly compact, hardy and looking their best. It results in one consistent crop after another, with well-proportioned plants achieving identically ideal form and color. While a small amount may be taken in through leaves, it is primarily absorbed through the stems and roots.

ACTIVE INGREDIENT Paclobutrazol



32oz
SYN13869
Min Buy 1 QT



Other

Avid® .15EC Miticide / Insecticide

For control of leaf miners and mites and suppression of aphids, whiteflies and thrips on ornamental plants. Rain fast within hours of application, offering outdoor application flexibility and is odorless. Also leaves no unsightly residue on plants.

ACTIVE INGREDIENT Abamectin



8oz
SYN25873
Min Buy 1 BT

1gal
SYN15128
Min Buy 1 GL



32oz
SYN81141
Min Buy 1 QT



Insecticides & Miticides

Hyshield™

HYSHIELD™ is a Chitosan-based plant supplement derived from crab shells that triggers the plant's natural defense responses, acting as a preventative against pests and disease. Additionally, HYSHIELD™ reduces transpiration, boosts stalk size and yield, and improves the quality of flowers and fruit.

ACTIVE INGREDIENT Chitosan



1L
SIP02FGHY001LTUS
UPC 776190999904
Min Buy 12 EA

10L
SIP02FGHY010LTUS
UPC 776190999881
Min Buy 2 EA

4L
SIP02FGHY004LTUS
UPC 776190999898
Min Buy 4 EA

20L
SIP02FGHY020LTUS
UPC 776190999874
Min Buy 1 EA





CONTAINERS



Fabric

Root Pouch Single Use Natural Fabric Container



Root Pouch Charcoal Line is a 150g/m² single-use fabric for commercial hydroponic grow rooms. Root Pouch is the only fabric container company that offers natural fiber blended fabrics. Designed for medical, recreational, or edible grow rooms. Perfect for Veg – Flower – Young plants.

Item #	Color	Capacity	Dimensions	UPC	Min Buy
NO HANDLES					
RTPC30001	Charcoal	1gal	6in W x 7.5in H	848039000215	25ea
RTPC30002	Charcoal	2gal	8.5in W x 8.5in H	848039000222	25ea
RTPC30003	Charcoal	3gal	10in W x 8.5in H	848039000239	25ea
RTPC30005	Charcoal	5gal	11in W x 10.25in H	848039000246	25ea
RTPC30007	Charcoal	7gal	14in W x 11.75in H	848039000253	25ea



Root Pouch Natural Fiber Blend Fabric Container

Root Pouch Grey Line is the most versatile semi-degradable Root Pouch available. Root Pouch is the only fabric container company that offers natural fiber blended fabrics. In-ground: natural fibers draw water from surrounding soil pot-in-pot prevents roots from penetrating fabric because it prunes by entrapment rather than air pruning. When used above ground roots are still pruned. Made from 100% recycled materials, PET & Natural fiber blend.

Item #	Color	Capacity	Dimensions	UPC	Min Buy
WITH HANDLES					
RTPG20003H	Grey	3gal	10in W x 8.5in H	848039001564	10ea
RTPG20005H	Grey	5gal	11in W x 10.25in H	848039001571	10ea
RTPG20007H	Grey	7gal	14in W x 11.75in H	848039001588	10ea
RTPG20010H	Grey	10gal	16in W x 12in H	848039001595	10ea
NO HANDLES					
RTPG20003	Grey	3gal	10in W x 8.5in H	848039001359	25ea
RTPG20005	Grey	5gal	11in W x 10.25in H	848039001366	10ea





Fabric

Root Pouch Synthetic Blend Multi Use Fabric Container

Entrapment pruning prevents roots from penetrating fabric and does not prune by air, allowing for pot-in-pot use. When used above ground roots are still pruned. Recommended uses: above ground growing and pot-n-pot. Usable season after season.

Item #	Color	Capacity	Dimensions	UPC	Min Buy
--------	-------	----------	------------	-----	---------

WITH HANDLES



RTPBB90005H	Brown	5gal	11 in W x 10.25in H	848039002417	10ea
RTPBB90007H	Brown	7gal	14in W x 11.75in H	848039002424	10ea
RTPBB90010H	Brown	10gal	16in W x 12in H	848039002431	10ea
RTPBB90015H	Brown	15gal	17in W x 15in H	848039002448	10ea
RTPBB90020H	Brown	20gal	19.8in W x 15.8in H	848039002455	10ea
RTPBB90035H	Brown	35gal	23.5in W x 17.8in H	848039002489	10ea
RTPBB90065H	Brown	65gal	32in W x 18in H	848039002509	5ea



NO HANDLES



RTPBB90003	Brown	3gal	10in W x 8.5in H	848039002196	10ea
RTPBB90005	Brown	5gal	11 in W x 10.25in H	848039002202	10ea
RTPBB90007	Brown	7gal	14in W x 11.75in H	848039002219	10ea
RTPBB90010	Brown	10gal	16in W x 12in H	848039002226	10ea
RTPBB90015	Brown	15gal	17in W x 15in H	848039002233	10ea
RTPBB900100	Brown	100gal	38in W x 20in H	848039002301	5ea
RTPBB900200	Brown	200gal	50in W x 24in H	848039002325	5ea



Root Pouch Synthetic Blend Multi Use Fabric Container

The Root Pouch black line is the most durable semi-degradable root pouch available. Can be used for in-ground production, pot-in-pot or above ground.

Item #	Color	Capacity	Dimensions	UPC	Min Buy
--------	-------	----------	------------	-----	---------

WITH HANDLES



RTPRR80005H	Black	5gal	11 in W x 10.25in H	848039000734	10ea
RTPRR80010H	Black	10gal	16in W x 12in H	848039000758	10ea
RTPRR80015H	Black	15gal	17in W x 15in H	848039000765	10ea





Fabric

Root Pouch Synthetic Blend Multi Use Fabric Container

Root Pouch Grey Line is the most versatile semi-degradable Root Pouch available. Root Pouch is the only fabric container company that offers natural fiber blended fabrics. In-ground: natural fibers draw water from surrounding soil pot-in-pot prevents roots from penetrating fabric because it prunes by entrapment rather than air pruning. When used above ground roots are still pruned. Made from 100% recycled materials, PET & Natural fiber blend

Item #	Color	Capacity	Dimensions	UPC	Min Buy
WITH HANDLES					
RTPG20015H	Grey	15gal	17in W x 15in H	848039001618	10ea
RTPG20020H	Grey	20gal	19.8in W x 15.8in H	848039001618	10ea
RTPG20025H	Grey	25gal	21in W x 16.5in H	848039001625	10ea
RTPG20030H	Grey	30gal	24in W x 16.5in H	848039001632	10ea
RTPG20045H	Grey	45gal	27in W x 18in H	848039001656	10ea



root pouch
www.rootpouch.com

GAIN A TACTICAL ADVANTAGE

Best choice for CEA grow rooms

Light Weave
Maximum oxygen exchange

Air Flow

Best Choice for:
All indoor growing

Synthetic (PET) Fibers
Strength

Grey & Charcoal
Natural Fiber Blend

Natural Fibers
Enhanced thermal capabilities
Natural Fibers are evenly distributed
throughout the bag for even hydration

Two Fibers Blended Together
Synthetic (PET) & Natural fibers

Makes all other pots or grow bags obsolete.





Fabric

SmartPot® Fabric Aeration Container

Made with black, long lasting, porous material that promotes air root pruning, excellent drainage and allows excess heat to escape, producing superior plants. Weather-resistant material allows the planter to be reused year after year. Made in the USA. BPA and lead free.



Item #	Color	Capacity	Dimensions	UPC	Min Buy
WITH HANDLES					
HCG14003	Black	3gal	10in Base x 7.5in H	674344140038	50ea
HCG14005	Black	5gal	12in Base x 9.5in H	674344140052	50ea
HCG14007	Black	7gal	14in Base x 10.5in H	674344140076	50ea
HCG14010	Black	10gal	16in Base x 11.5in H	674344140106	50ea
HCG14015	Black	15gal	18in Base x 13.5in H	674344140151	50ea
HCG14020	Black	20gal	20in Base x 15.5in H	674344140205	50ea
HCG14025	Black	25gal	21in Base x 15.5in H	674344140250	50ea
HCG14030	Black	30gal		674344140304	50ea
HCG14045	Black	45gal	27in Base x 18in H	674344140458	50ea
NO HANDLES					
HCG10001	Black	1gal	7in Base x 6in H	674344100018	10ea
HCG10002	Black	2gal		674344100025	100ea
HCG10003	Black	3gal	10in Base x 7.5in H	674344100032	10ea
HCG10005	Black	5gal	12in Base x 9.5in H	674344100056	10ea
HCG10007	Black	7gal	14in Base x 9.5in H	674344100070	10ea
HCG10010	Black	10gal	16in Base x 11.5in H	674344100100	10ea
HCG10015	Black	15gal	18in Base x 13.5in H	674344100155	10ea
HCG10020	Black	20gal	20in Base x 15.5in H	674344100209	10ea
HCG10025	Black	25gal	21in Base x 15.5in H	674344100254	10ea
HCG10030	Black	30gal		674344100308	50ea
HCG10045	Black	45gal	27in Base x 18in H	674344100452	50ea
HCG10065	Black	65gal	32in Base x 18in H	674344100650	50ea



Nursery Pots

Nursery Supplies® Econo-Grip® Blow-Molded Pot

Blow molded container is an economy weight version of Grip-Lip®. It has the same great features as the Grip-Lip® in a lighter weight, making it the perfect choice for the liner of a Pot-In-Pot or AGS® Above Ground System application.



Item #	Style	Trade Size	Color	qty/cs	cs/pl	Dimensions	Capacity	Barcode
NS01046500031	EG2800	#7	Black	20	32	13.75in D x 12in H	6.08gal (23.02L)	
NS01-04700-0041	EG4000	#10	Black	19	18	14.25in D X 14.25in H	9.16gal (34.68L)	
NS01-04730-0271	EG6900S	#10	Black	17	10	17.25in D X 12.125in H	10.69gal (40.46L)	
NS01047400301	EG6900	#15	Black	17	10	17.25in W x 15.125in D	13.19gal (49.92L)	
NS01-04800-0141	EG8000	#20	Black	16	8	19.5in D X 17in H	19.5gal (73.82L)	
NS01-04820-0141	EG10000S	#20	Black	14	12	22.75in W x 13.125in D	20.51gal (77.63L)	
NS01-04850-0100	EG10000	#25	Black	10	15	22.75in D x 18.125in H	27.59gal (104.44L)	

Nursery Supplies® Grip-Lip® Blow-Molded Pot

These containers are designed to provide maximum stacking and shipping strength. They ease the strain of maneuvering plants and trees because the lip becomes a rigid handle. And, this unique lip design makes the Grip-Lip® extremely comfortable to lift, yet strong enough to be carried by a forklift.



Item #	Style	Trade Size	Color	qty/cs	cs/pl	Dimensions	Capacity	Barcode
NS01046500541	GL2800	#7	Black	20	32	13.75in D x 12in H	6.08gal (23.02L)	
NS01-04700-0561	GL4000	#10	Black	19	18	14.25in D X 14.25in H	9.16gal (34.68L)	
NS01047400801	GL6900	#15	Black	17	10	17.25in W x 15.125in D	13.19gal (49.93L)	
NS01-04800-0101	GL8000	#20	Black	16	8	19.5in W x 17in D	19.5gal (73.82L)	
NS01-04820-0551	GL10000S	#20	Black	14	12	22.75in W x 13.125in D	20.51gal (77.63L)	
NS01-04850-0500	GL10000	#25	Black	10	15	22.75in D X 18.125in H	27.59gal (104.44L)	



Nursery Pots



Nursery Supplies® Blow-Molded

Offers exceptional durability, strength, and value. This line of containers are typically ribbed, but some are also available with smooth sides. Sizes range from #SP-4 all the way up to large #45 and #65. We also give you a choice of container weight to match your needs.

Item #	Style	Trade Size	Color	qty/cs	cs/pl	Dimensions	Capacity	Barcode
--------	-------	------------	-------	--------	-------	------------	----------	---------

CLASSIC CUSTOM™ BLOW-MOLDED POT - ECONOMY LINE

NS01-00250-0291	300CU	#1	Black	100	92	6.375in D x 7.25in H	.73gal (2.78L)	
NS01-00200-1361	300SCU	#1	Black	106	98	6.5in D x 6.5in H	.63gal (2.37L)	
NS01-00270-0301	350CU	#1	Black	130	64	8in D x 5.125in H	.77gal (2.90L)	
NS01-00300-0900	400CU	#1	Black	92	70	7.75in D x 7in H	1gal (3.79L)	
NS01-00430-0551	550CU	Large	Black	97	50	9in D x 6.125in H	1.21gal (4.58L)	
NS01-00450-1381	600CU	#2	Black	105	50	9in D x 8.5in H	1.5gal (5.68L)	
NS01-00490-0331	900CU	#2	Black	83	46	9.5in D x 9.125in H	1.94gal (7.33L)	
NS01-00540-0361	1200SCU	#2	Black	60	32	11in D x 7.5in H	2.32gal (8.78L)	
NS01-00500-0861	1000CU	#10	Black	70	36	10.125in D x 9.125in H	2.25gal (8.52L)	
NS01-00510-0130	1000SCU	#2	Black	75	36	10.125in D x 7.5in H	1.95gal (7.36L)	
NS01-00550-1111	1200CU	#3	Black	56	32	11in D x 9.5in H	3gal (11.36L)	
NS01-00590-0251	1600SCU	#3	Black	47	28	11.875in D x 7.875 H	2.87gal (10.85L)	
NS01-00580-0521	1600SCU	#5	Black	47	28	11.875in D x 10.125in H	3.58gal (13.55L)	
NS01-00600-0561	2000CU	#5	Black	44	28	11.875in D x 11in H	3.84gal (14.55L)	
NS01-00620-0400	2100CU	#5	Black	31	27	14in D x 9.875in H	5.17gal (19.58L)	
NS01-00650-0661	2800CU	#7	Black	31	27	14in D x 11.5in H	6.08gal (23.02L)	

OLYMPIAN® BLOW-MOLDED POT

NS01-00700-0211	4000BxL	#10	Black	27	16	15.75in D x 15in H	9.16gal (34.68L)	
NS01-00730-0171	6900SBxL	#10	Black	19	15	18.375in D x 12.125in H	10.66gal (40.37L)	
NS01-00740-0301	6900BxL	#15	Black	18	15	18.375in D x 15.125in H	13.35gal (50.54L)	
NS01-00850-0200	C10000BxL	#25	Black	10	15	23.75in D x 18.125in H	27.17gal (102.89L)	



Nursery Pots

Nursery Supplies® PI-PC Nursery Container

Economical PI injection-molded containers. Strong and rigid. Tier stacking. Label, hot stamp and printing compatible



Item #	Style	Trade Size	Color	qty/cs	cs/pl	Dimensions	Capacity	Barcode
NS01-05400-0111	PI-PC2	#2	Black	61	60	8.375in D x 8.375in H	1.78gal (6.74L)	
NS01-05450-0100	PI-PC3	#3	Black	40	45	10in D x 9.25in H	2.77gal (10.49L)	
NS01055500411	PC-5S	#5	Black	42		10.75in D x 10.5in H	4.08gal	
NS01-05650-0100	PI-PC7S	#7	Black	39		14in D x 11.25in H	6.92gal	
NS01-05700-0100	PI-PC10	#10	Black	27		15.25in D x 14.5in H	10.26gal	



Saucers & Plant Dolly

Bond® Plastic Saucer

Place under pots to protect floors from moisture, dirt and water damage.



Clear - 6in Diam
BONCVS006
UPC 034613340062
Min Buy 25 EA

Clear - 16in Diam
BONCVS016
UPC 034613340161
Min Buy 50 EA



Clear - 10in Diam
BONCVS010
UPC 034613340109
Min Buy 25 EA

Clear - 17in Diam
BONCVS017
UPC 034613340178
Min Buy 25 EA

Clear - 12in Diam
BONCVS012
UPC 034613340123
Min Buy 25 EA

Clear - 21in Diam
BONCVS021
UPC 034613340215
Min Buy 25 EA

Clear - 14in Diam
BONCVS014
UPC 034613340147
Min Buy 25 EA

Bond® Deep Plastic Saucer

Deeper for less spillage. Place under pots to protect floors from moisture, dirt and water damage.



Clear - 10in Diam
BONCVS010DL
UPC 034613002144
Min Buy 25 EA

Clear - 14in Diam
BONCVS014DL
UPC 034613014437
Min Buy 25 EA



Clear - 12in Diam
BONCVS012DL
UPC 034613012433
Min Buy 25 EA

Clear - 16in Diam
BONCVS016DL
UPC 034613016431
Min Buy 25 EA

Bond® Heavy-Duty Plastic Saucer

Made with heavy plastic for added strength and durability. Place under pots to protect floors from moisture, dirt and water damage.



Clear - 10in Diam
BONCVS010HD
UPC 034613002151
Min Buy 24 EA

Clear - 14in Diam
BONCVS014HD
UPC 034613014840
Min Buy 12 EA



Clear - 12in Diam
BONCVS012HD
UPC 034613012846
Min Buy 12 EA

Clear - 16in Diam
BONCVS016HD
UPC 034613016844
Min Buy 12 EA



Containers

Autopot™ 4 Pot System

The 4Pot System is extremely versatile and can be used for a wide range of plant types and sizes. Seasonal flowering plants and perennial shrubs thrive and produce an abundance of blooms and foliage because of the unique action of the AQUAvalve5™, which is designed to allow the plant to go through a wet & dry cycle.



12.4gal Reservoir

AUPAPWS001

UPC 818997010007

Min Buy 1 EA

**Autopot™ AQUAbox Spyder Self-watering Kit**

The AQUAbox Spyder offers a revolutionary self-watering solution for Grow Your Own enthusiasts. No mains water supply, pumps or timers are required. Simply connect to an existing water barrel to automatically water a 13sq/ft area.



13sq ft

AUPAPWS016

UPC 506015187008

Min Buy 1 EA

**Autopot™ AQUAbox Straight Watering Kit**

The AQUAbox Straight is designed to water and feed plants of all types and sizes that are grown directly in the soil. Positioned directly into the ground the AQUAbox Straight is ideal for watering narrow raised beds. Alternatively, it may be used in a tray to water a conventional grow bag.



4sq ft

AUPAPWS018

UPC 818997010526

Min Buy 1 EA

**Autopot™ Easy2Go™ Kit Plant Watering System**

Easy2GO™ is the ultimate holiday watering kit for happy, healthy plants. By incorporating the patented AQUAvalve™, the easy2GO™ will keep plants watered for weeks using a simple gardening tray and reservoir. The easy2GO™ is placed directly onto the tray along with your potted plants and distributes water to the pots from below. Unlike other holiday watering kits, the easy2GO™ provides optimum levels of water to meet the plants requirements – without the need for timers or electricity – ensuring you return from holiday to plants that are thriving.



AUPAP400

UPC 506015187018

Min Buy 10 EA

**Autopot™ Flexi Tank Pro™**

The FlexiTank Pro's reflective and light-tight skin beautifully disguises an extremely rugged, fully collapsible design within. Concealed reservoir supports and internal capacity markings add neat edges to the proven, ultra-strong, ultra-practical FlexiTank design.



25gal

AUPAPWSPRO25G

UPC 818997010472

Min Buy 1 EA

60gal

AUPAPWSPRO60G

UPC 818997010489

Min Buy 1 EA

105gal

AUPAPWSPRO105G

UPC 818997010496

Min Buy 1 EA

**Autopot™ XL System**

The 1Pot XL System is easily extended so many pots can be linked to a single reservoir. The pots & trays can be easily moved at will, if the plants grow too large they can be spaced further apart with ease. Once set up and a reservoir is filled with water & mineral liquid feed this extremely versatile system will completely take care of all your plants needs. All you need to do is remember to fill up your reservoir from time to time.



4 Pots

AUPAPWS158

UPC 736542837537

Min Buy 1 EA





Saucers & Plant Dolly

Devault® Plant Dolly

Heavy duty plant dolly made of high impact plastic, perfect for whiskey barrels and large pots. Features steel ball bearing casters and five rubber wheels. Prevents stains on your deck or patio.



Black - 16in Diam / Supports up to 500lbs

DEV3000B

UPC 837839003229

Min Buy 8 EA

Black - 24in Diam / Supports Up to 500lbs

DEV2400B

UPC 837839003236

Min Buy 4 EA



Devault® Plant Dolly with Hydro Fittings

Heavy duty plant dolly with hydro fitting, made of high impact plastic. Features steel ball bearing casters and five rubber wheels. Prevents stains on your deck or patio.



Black - 24in Diam / Supports Up to 500lbs

DEV2400HY

UPC 837839003342

Min Buy 4 EA



Fabric

DeWitt® GRO POT Flexible Planter Bag

Ventilated design provides excellent root zone aeration and drainage and conserves water. The round bottom prevents tipping and is easier to fill and the sturdy handles make plants easy to lift and transport. The durable and flexible fabric is made of 100% polypropylene and UV protected. Re-use season after season.



3gal Capacity - 9in W x 10.5in H - 2 Handles

DEWGROPOT3

UPC 042579823420

Min Buy 10 EA

6gal Capacity - 12.5in W x 13.5in H - 2 Handles

DEWGROPOT6

UPC 042579823437

Min Buy 10 EA

9gal Capacity - 14in W x 14in H - 2 Handles

DEWGROPOT9

UPC 042579823444

Min Buy 10 EA

12gal Capacity - 15.5in x 15.75in H - 2 Handles

DEWGROPOT12

UPC 042579823451

Min Buy 10 EA

15gal Capacity - 16.5in W x 17.75in H - 4 Handles

DEWGROPOT15

UPC 042579823468

Min Buy 10 EA

25gal Capacity - 20in W x 20in H - 4 Handles

DEWGROPOT25

UPC 042579823475

Min Buy 10 EA



Nursery Pots

Landmark® Nursery Container

Bi-level drainage promotes air pruning and discourages root circling. Large surface area for labeling and printing. ideal for use in automation equipment. Available in solid or co-ectruded colors.



Black - Trade Size 1gal - 6.50in Diam x 6.5in Deep

- 1 CS / 200 EA

LNDX-65NTGTBK

Min Buy 1 CS



Flats, Trays, Inserts, Domes

Landmark® Dome

7in Clear Dome used with Carry Tray 1020. Has 2 vents that open and close.



Clear - 7in D x 10.80in W x 21.22in L

- 1 CS / 40 EA

LNDDOMELPC245CT

Min Buy 1 CS



Landmark® L Series Tray

Made of high-quality plastic resins for easy de-nesting, specifically designed to accommodate automation equipment.



Gray - L1020NCRN - No Drainage Holes

21.22in L x 10.8in W x 2.33in D - 1 CS / 100 EA

LNDL1020NCRNNOHOLE

Min Buy 1CS





Containers

EarthBox® Garden Kit

Poor soil conditions and small backyards are no match for this gardening system. Now it's easy to garden anywhere--even on balconies, porches, and rooftops! A sustainable product that uses less water and fertilizer, the EarthBox® gardening system will grow bigger and tastier plants faster than a conventional garden--with virtually no effort and zero guesswork! Great results, no matter what color your thumb is. All plastic components are durable, food-safe and UV-stabilized. Holds 2cu ft of peat-based growing media and 3gal of water. Includes one EarthBox® container with integrated overflow drain and caster sockets, one aeration screen, one water fill tube, two mulch covers, four casters, 16oz 7-7-7 fertilizer, 16oz organic Dolomite and instruction sheet.



Green - Display - 29in L x 11in W x 14in H
EBX8010104

UPC 026978801012

Min Buy 4 EA



EarthBox® Organic Garden Kit

Poor soil conditions and small backyards are no match for this gardening system. Now it's easy to garden anywhere--even on balconies, porches, and rooftops! A sustainable product that uses less water and fertilizer, the EarthBox® gardening system will grow bigger and tastier plants faster than a conventional garden--with virtually no effort and zero guesswork! Great results, no matter what color your thumb is. All plastic components are durable, food-safe and UV-stabilized. Holds 2cu ft of peat-based growing media and 3gal of water. Includes one EarthBox® container with integrated overflow drain and caster sockets, one aeration screen, one water fill tube, two mulch covers, four casters, 16oz organic 8-3-5 fertilizer, 16oz organic Dolomite and instruction sheet.



Green - Display - 29in L x 11in W x 14in H - 12pc
EBX8015112

UPC 026978801514

Min Buy 1 DS



EarthBox® Organic Garden Kit

Poor soil conditions and small backyards are no match for this gardening system. Now it's easy to garden anywhere--even on balconies, porches, and rooftops! A sustainable product that uses less water and fertilizer, the EarthBox® gardening system will grow bigger and tastier plants faster than a conventional garden--with virtually no effort and zero guesswork! Great results, no matter what color your thumb is. All plastic components are durable, food-safe and UV-stabilized. Holds 2cu ft of peat-based growing media and 3gal of water. Includes one EarthBox® container with integrated overflow drain and caster sockets, one aeration screen, one water fill tube, two mulch covers, four casters, 16oz organic 8-3-5 fertilizer, 16oz organic Dolomite and instruction sheet.



Terra Cotta - 29in L x 11in W x 14in H
EBX80155

UPC 026978801555

Min Buy 4 EA



Flats, Trays, Inserts, Domes

PlantBest™ Vented Humidity Dome

Clear dome made with 100% recycled plastic, helps maintain a humid environment for starting seeds and seedlings. Adjustable vent.



6in H
PPR3461

UPC 770932108005

Min Buy 18 EA



PlantBest™ Greenhouse Dome

Clear dome made with 100% recycled plastic, helps maintain a humid environment for starting seeds and seedlings.



Fits Standard 10x20 Flat
PPR4062PA

UPC 770932108098

Min Buy 48 EA



Propagation

PlantBest™ Biodegradable Coconut Coir Pots

Seed and cuttings flourish in our biodegradable, plantable coconut coir pots. Coconut coir helps ensure less mold growth occurs when compared to peat and/or paper based pots.



2.5in Diam Pots, 12pk
PPR3488

UPC 770932039408

Min Buy 24 EA

3.25in Diam Round Pots, 8pk
PPR3489

UPC 770932048400

Min Buy 24 EA

4.5in Diam Round Pots, 6pk
PPR3490

UPC 770932040411

Min Buy 24 EA



GrowerSelect®

Flats, Trays, Inserts, Domes

Grower Select® Transport Trays

Holds pots upright on benches. Makes it easy to move the smaller pots without tipping within the greenhouse. Thermoformed plastic construction.



Item #	Fits	Weight	qty/ cs	Coordinating Co-Ex Pot	Dimensions	Fits Qty of Pots	Barcode
--------	------	--------	------------	---------------------------	------------	---------------------	---------

FOR SQUARE POTS

RIPHST35018	3.5in Square Pot	175g	110	RIPHSCP350	21.25in L x 10.83in W x 1.97in H	18	
RIPHST45015	4.5in Square Pot	185g	70	RIPHSCP450 & RIPHSCP450D	20.86in L x 12.4in W x 2.36in H	15	

FOR ROUND POTS

RIPHST400-15CS	4in Round Pot	220g	70	RIPHSP400	20in L x 12in W x 3.625in H	15	
RIPHST433W-10CS	4.33in Wide Round Pot	155g	75	RIPHSP433W	21.63in W x 8.63in L x 3.78in H	10	



50 Square Cell Plug Tray



72 Square Cell Plug Tray

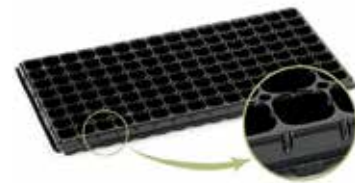

128 Square Cell Plug Tray

Grower Select® Plug Trays

Features a glossy finish for easy dislodging of your plugs. Standard tray size of 21.25in L x 11in W

Item #	# of Cells	qty/cs	Dimensions	Cell Volume	Weight	Cell Shape	Barcode
BUMS50/135/100	50	100	1.97in Top Diam x 1.19in Base Diam x 1.81in H	73CC	135g	Square	
BUMS72/135/100	72	100	1.42in Top Diam x 0.875in Base Diam x 1.97in H	34CC	135g	Square	
BUMS128/165/100	128	100	1.11in Top Diam x 0.67in Base Diam x 1.625in H	17.5CC	165g	Square	

Propagation



Grower Select® Round Co-Extruded Standard Pot

Standard co-extruded pot, economical for the greenhouse. Sturdy pots to fit grower needs, including a dark inner lining to protect plant roots. Custom fit to be a perfect match to our carry trays.

Item #	Description	Dimensions	Liquid Volume	Coordinating Carry Tray	qty/cs	Barcode
--------	-------------	------------	---------------	-------------------------	--------	---------

SQUARE POTS

RIPHSCP350	3.5in Standard Square	3.5in D x 3.5in H	1.08pt	RIPHSPT35018	684	
RIPHSCP450	4.5in Standard Square	4.2in D x 3.62in H	1.25pt	RIPHSPT45015	450	

ROUND POTS

RIPHSP400BLK	4in Standard Round	4in D x 3.5in H	1pt	RIPHST400-10cs RIPHST400-15cs	1900	
RIPHSP433WBLK	4.33in Wide Bottom Round	4.33in D x 3.75in H	1.3pt	RIPHST433W-10cs	1800	



Saucers & Plant Dolly

Plant Stand® Down Under Plant Saucer

Lifts pots to allow air flow and prevents water damage to decks, wooden floors and carpets. Will support up to 500lbs.



Clear - 17in Diam

PSN51740

UPC 641341517408

Min Buy 12 EA

Clear - 21in Diam

PSN52140

UPC 641341521405

Min Buy 12 EA



Plant Stand® Down Under Plant Caddie®

Features five high quality, durable nylon and steel wheels and one locking caster to keep caddie securely in place. Constructed of UV resistant plastic. Will support and move up to 500lbs with ease.



Black - 16in Diam

PSN18410

UPC 641341184105

Min Buy 6 EA

Black - 20in Diam

PSN20410

UPC 641341204100

Min Buy 6 EA





Fabric

Roots Organics Root Pot

Made from 100% recycled material. Aurora Innovations Root Pots are soft-sided, fabric planters that allow roots to breathe and water to evaporate more evenly. Promotes a dense and fibrous root structure and allows evaporative cooling in hot climates and thermal insulation in cold climates.



3gal

AURRP3

UPC 609728631178

Min Buy 25 EA

5gal

AURRP5

UPC 609728631185

Min Buy 10 EA

7gal

AURRP7

UPC 609728631192

Min Buy 10 EA



SUNBLASTER

HORTICULTURAL LIGHTING

Flats, Trays, Inserts, Domes

SunBlaster™ High Vented Humidity Dome

Vented dome for 1020 trays. Tray sold separately.

**SBL1400230**

UPC 628836142307

Min Buy 25 EA

**SunBlaster™ NanoDome**

High humidity dome incorporates the SunBlaster lighting tracks for supporting & retaining lights. Vented for optimum humidity & temperature control. Use with 1020 trays. Tray and lights sold separately.

**SBL1400232**

UPC 628836142321

Min Buy 25 EA

**SunBlaster™ Double Thick Seed Tray**

Twice as thick as traditional 1020 propagation flats, and includes holes. This tray will last crop after crop, year after year.



11 in x 21 in x 2.5 in

SBL1400221

UPC 628836142215

Min Buy 50 EA

**SunBlaster™ Extra Heavy Duty 1020 Trays**

These 1020 trays are the thickest, and toughest in the industry. Four times as thick as a traditional 1020 tray.



Quad Thick

SBL1400235

UPC 628836142352

Min Buy 25 EA

**SunBlaster™ Heavy Duty 1020 Trays**

These traditional 1020 sized thermoformed trays are twice the thickness of the standard 1020 tray, making them truly rugged and long lasting. No need to stack two together for stability. Ideal for commercial greenhouse applications, and the indoor gardening enthusiast.



Double Thick

SBL1400220

UPC 628836142208

Min Buy 50 EA



Flats, Trays, Inserts, Domes

T.O. Plastics Plug Trays

Maximum cell sizes for optimum soil capacity. Optional ventilation holes for greater air movement. Larger label ramps to meet most grower requirements. Precisely centered, punched drain holes. Cell bottom buttons slightly elevate trays on benches. Cell wall "root ribs" and star trays for enhanced downward root growth.

- Standard plug trays 11 in x 21.22in perimeter trim.
- PL-32-STAR-DP-HW-STY 11 in x 21.5in perimeter trim.
- Star plug trays 10.94in x 21.44in perimeter trim.
- PL-SR-15 12.88in x 21.19in perimeter trim.
- PL-SR-50 10.94in x 21.44in perimeter trim.

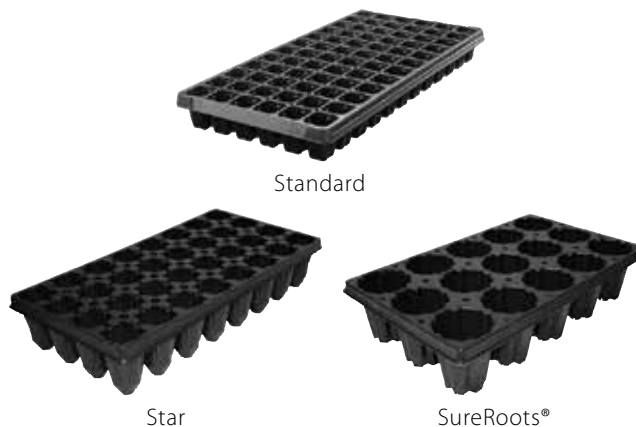

Item #	Style	qty/ cs	cs/ pl	Cell Foot Print	Drain Hole	Vent Hole	Dimensions	Volume per Cell	Barcode
STANDARD PLUG TRAYS									
TO720463C	PL-50	100	24	5 x 10	0.37	0.25	1.9in D x 2.37in H	3.75oz (6.77cu in)	
TO720487C	PL-128	100	32	8 x 16	0.31	0.18	1.19in D x 2in H	.85oz (1.53cu in)	
TO720469C	PL-072	100	24	6 x 12	0.37	0.25	1.52in D x 2.25in H	1.99oz (3.60cu in)	
TO720477C	PL-098	100	24	7 x 14	0.37	0.25	1.34in D x 2in H	1.25oz (2.26cu in)	
STAR PLUG TRAYS									
TO720556C	PL-32-DP	50	24	4 x 8	0.62	0.62	2.22in D. x 4.00in H	5.58oz (10.07cu in)	
TO720562C	PL-38-DP	25	32	3 x 8 7 x 2	0.75		2.13in D x 5in H	7.44oz (13.43cu in)	
TO720568C	PL-50-DP	50	24	5 x 10	0.62	0.50	1.94in D x 4.5in H	4.80oz (8.66cu in)	
TO720582C	PL-72-DP	50	32	6 x 12	0.43	0.50	1.56in D x 3.0in H	2.37oz (4.27cu in)	
SURERROOTS® PLUG TRAYS									
TO720715C	PL-SR-15-HW-VH	25	42	3 x 5	1.25	0.50	3.55in D x 4.59in H	18.33oz (33.07cu in)	
TO720720C	PL-SR-15-VH	25	56	3 x 5	1.25	0.50	3.55in D x 4.59in H	19.07oz (34.42cu in)	
TO720700C	PL-SR-50-DP-VH	25	32	5 x 10	0.625	0.25	2in D x 5in H	6.59oz (11.90cu in)	



Flats, Trays, Inserts, Domes

T.O. Plastics Flats

For use with standard inserts. Sturdy, yet lightweight for easy handling.



Item #	Style	Color	qty/cs	cs/pl	Dimensions	Barcode
TO710245C	STF-1020-OPEN	Black	100	40	21.44in L x 10.94in W x 2.44in H	
TO710251C	STF-1020-OPEN-NH	Black	100	40	21.44in L x 10.94in W x 2.44in H	
TO790910C	STF-1020-WEB-SS	Black	50	48	21.26in L x 10.75in W x 2.37in H	

T.O. Plastics Square Pot Carry Trays

100% recycled resins extruded into high impact carry trays. You are sure to save time and money with the ease of the Press-Fill system.



Item #	Style	Fits	qty/cs	cs/pl	Dimensions	Fits Qty of Pots	Barcode
TO705105C	SPT-250-32-PF	2.5in	100	24	21.19in L x 10.75in W x 2.5in H	32	
TO705130C	SPT-350-18-PF	3.5in	100	24	21.25in L x 10.81in W x 1.93in H	18	
TO705137C	SPT-355-18-DP	3.5in	50	24	21.25in L x 10.81in W x 3.5in H	18	
TO705165C	SPT-450-15-PF	4.5in	50	24	21.19in L x 12.88in W x 2.13in H	15	

T.O. Plastics Plastic Dome

Clear Plastic Dome for seed starting, fits a 1020 standard size tray.



STF-1020-CLEAR-DOME - Clear
 50/cs - 56cs/pl
 21.5in L x 11in W x 2.10in H
 Thermoformed
TO760549C
 Min Buy 1 CS









Containers



T.O. Plastics Square Vacuum Traditional & Deep Pots

100% recycled resins that are extruded, then formed into high-impact polystyrene square plant pots. Durable, dependable and environmentally responsible plant pots with the efficiency of our Press-Fill system.

Item #	Style	Size	Color	qty/cs	cs/pl	Dimensions	Volume	Barcode
TRADITIONAL POTS								
TO700087C	SVT-450	4.5in	Black	375	28	4.2in D x 3.62in H	1.72pt (49.73cu in)	
TO700081C	SVT-450	4.5in	Black	500	24	4.2in D x 3.62in H	1.72pt (49.73cu in)	
DEEP POTS								
TO700003C	SVD-250	2.5in	Black	800	48	2.6in D x 3.44in H	7.84oz (14.46cu in)	
TO700026C	SVD-350	3.5in	Black	450	48	3.52in D x 3.5in H	1.08pt (31.43cu in)	
TO700035C	SVD-355	3.5in	Black	450	40	3.52in D x 5in H	1.5pt (42.45cu in)	
TO700051C	SVD-450	4.5in	Black	375	28	4.2in D x 4.91in H	1.13qt (65.42cu in)	
TO700062C	SVD-450	4.5in	Black	500	24	4.2in D x 4.91in H	1.13qt (65.42cu in)	



Saucers & Plant Dolly

Curtis Wagner Plastics Deep Plant Saucer

Each saucer has an airflow bottom design that does not trap moisture, dirt, etc. under the saucer.



Black - 12in Diam

CWPBLK812

UPC 759188812119

Min Buy 25 EA

Black - 25in Diam

CWPBLK2500

UPC 759188251000

Min Buy 25 EA



Curtis Wagner Plastics Vinyl Plant Saucer

Each saucer has an airflow bottom design that does not trap moisture or dirt under the saucer. Saucers de-nest easily; they will not stick together.



Black - 14in Diam

CWPBLK814

UPC 759188814113

Min Buy 25 EA

Black - 16in Diam

CWPBLK816

UPC 759188816223

Min Buy 25 EA

Black - 21in Diam

CWPBLK2100

UPC 759188211004

Min Buy 20 EA





Leader in
Horticultural
Containers

Containers

The HC Companies® Deep Press Fit Pot

Co-extruded with dual color layering with a dark interior for maximum root protection from light. Lightweight, yet durable polypropylene for greater cost efficiency. Multi-level drain holes for efficient drainage. Strong rims for efficient use in high-speed automated systems.



Item #	Code	Color	Qty	Dimensions	Max Liquid Volume	Tray Compatibility	Barcode
3.00 SQUARE DEEP VACUUM POT - PRESS FIT							
DLNSVP03001G18C800	SVP03001	Black	800	2.62in D x 3.5in H	9.47floz	TCS32300 TCS25300 TCS14301	
4.00 SQUARE DEEP VACUUM POT - PRESS FIT							
DLNSVP04001G18C450	SVP04001	Black	450	3.5in D x 3.5in H	1.08pt	TC1S8401	
4.50 SQUARE VACUUM POT - PRESS FIT							
DLNSVP04501G18C375	SVP04501	Black	375	4.12in D x 3.62in H	1.65pt	TCS10452 TCS12450 TCS15451	
4.50 SQUARE DEEP VACUUM POT - PRESS FIT							
DLNSVP0450DG18C375	SVP0450D	Black	375	4.12in D x 5in H	1.2qt	TCS15451 TCS15452 TCS12450 TCS10452	
5.00 M6 SQUARE POT							
DLNXSQ00M60G18C468	XSQ00M60	Black	468	5in D x 5.37in H	1.5qt	TCS08M60	



The HC Companies® Jumbo Thinwall Pot with Tag Locator (Square)

Designed with large soil capacity to specifically accommodate perennial root systems.

Item #	Code	Color	Qty	Dimensions	Max Liquid Volume	Tray Compatibility	Barcode
DLNSQJ05502G18C288	SQJ05502	Black	288	5.03in W x 5.62in H	1.89qt	TCS08M60	



Leader in Horticultural Containers

Containers

The HC Companies® Azalea Traditional Thinwall Pot

Made from high-grade polypropylene. Bulk packaging available, making shipping and storage more efficient and providing additional savings to the grower.



Item #	Code	Color	Qty	Dimensions	Max Liquid Volume	Tray Compatibility	Barcode
DLNAZN06501G18C240	AZN06501	Black	240	6.5in D x 4.93in H	2.01qt	TIA06500	

The HC Companies® Trade 1 Gallon Squat Pot

Co-Extruded with dual color layering with a dark interior for maximum root protection from light. Lightweight, yet durable polypropylene for greater cost efficiency. Multi-level drain holes for efficient drainage. Strong rims for efficient use in high-speed automated system.



Item #	Code	Color	Qty	Dimensions	Max Liquid Volume	Tray Compatibility	Barcode
DLNXNS0T1G3G18C140	XNS0T1G3	Black	140	6.5in D x 6.5in H	2.50qt	TCR06SG1 TCF06SG0 TIS5G034 TIS66651	

The HC Companies® FiberGrow® Growing Container (Round)

Superior Growing Containers that breathe like clay, improve aeration and promote healthier root systems by insulating them from temperature fluctuations.



Item #	Code	Qty	Dimensions	Max Liquid Volume	Barcode
ITMLFNP10110RBRD025	FNP10110	25	10.5in D x 10.5in H	2.90gal	
ITMLFNP12110RBRD020	FNP12110	20	12.0in D x 10.75in H	4.13gal	

The HC Companies® EcoGrow® Growing Container

Manufactured with the environment in mind in our North American, closed loop water recycling production facility. Automation friendly carry trays available in all sizes. Built-in denesting lugs for ease of handling.



3.5in Diam x 3.25in H
- 1 CS / 720 EA
ITMLFRS03501RBIC720
Min Buy 1 CS

4.5in Diam x 3.75in H
- 1 CS / 322 EA
ITMLFRS04500RBIC322
Min Buy 1 CS



Leader in
Horticultural
Containers

Flats, Trays, Inserts, Domes

The HC Companies® Open Web Carry Tray

Injection flats deliver increased flexibility and are economically constructed using quality, blended, recycled raw material with additives. Designed for consistent performance in automated filling and handling equipment.



Item #	Weight	Code	Qty	Dimensions	Barcode
DLNTWA10206G18D050	1020 Standard Light Weight Flat	TWA10206	50	21.125in L x 10.5in W x 2.5in H	
DLNTWT10200G18D050	1020 True Medium Weight Flat	TWT10200	50	20in L x 10in W x 2.5in H	
DLNTWA10207G18D050	1020 Standard Medium Weight Flat	TWA10207	50	21.125in L x 10.5in W x 2.5in H	
DLNTWA10200G18D050	1020 Standard Heavy Weight Flat	TWA10200	50	21.125in L x 10.5in W x 2.5in H	



The HC Companies® Standard Insert

Vacuum formed, high quality bedding plant containers. Precision burned holes and die cut trims deliver consistent performance.

Item #	Code	Qty	Dimensions	Max Liquid Volume	Tray Compatibility	Barcode
DLNIJA06060G18C100	Jumbo IJA06060	100	20in L x 10in W x 3.25in H	1.33qt	TND10200 TR..K100 TWA10207 TWA10200 TVA11210 TVA11210J TVA11212 TVA.R6.0	
DLNINA08010G18C100	INA08010	100	21in L x 10.5in W x 2.25in H	1.71pt	TND10200 TR..K100 TWA10207 TWA10200 TVA11210 TVA11210J TVA11212 TVA.R8.0	



Leader in Horticultural Containers

Flats, Trays, Inserts, Domes

The HC Companies® Press Fit Tray

Durable and rigid construction delivers consistent handling performance in every step of the supply chain. Designed to work on roller conveyors and automated potting systems. Works well in automated tray dispensers.



Item #	Code	Qty	Dimensions	Pot Compatibility	Barcode
18-POCKET CARRY TRAY FOR 4.00IN SQUARE PRESS FIT POTS					
DLNTCS18401G18C050	TCS18401	50	21.25in L x 10.625in W x 2.375in H	SVP04001, INP18011	
15-POCKET CARRY TRAY FOR 4.50IN SQUARE INJECTION PRESS FIT POTS					
DLNTCS15451G18C050	TCS15451	50	21.25in L x 13in W x 2in H	SVP04501, SVP0450D	

The HC Companies® Universal Spacer Tray

Open design provides optimal air circulation which prevents algae bloom and stimulates plant growth. Lock pots safely inside the tray making them ideal for multiple transport, growing, and shipping applications. Also perfect for capillary mats, ebb and flood, or flooded floor watering systems



Black - 19in L x 12.6in W x 2.6in H
 - 1 CS / 25 EA
DLNTIS66651G18D025
 Min Buy 1 CS



The HC Companies® Standard Full Depth Flat (Open/No Holes)

Vacuum formed flats are constructed from sturdy gauge polystyrene material for durability. Designed for consistent performance in automated filling and handling equipment.



Black - 21in L x 10.5in W x 2.375in H
 - 1 CS / 100 EA
DLNTVA11210G18C100J
 Min Buy 1 CS



Ask your BFG sales representative for more information on HC cannabis growing containers!

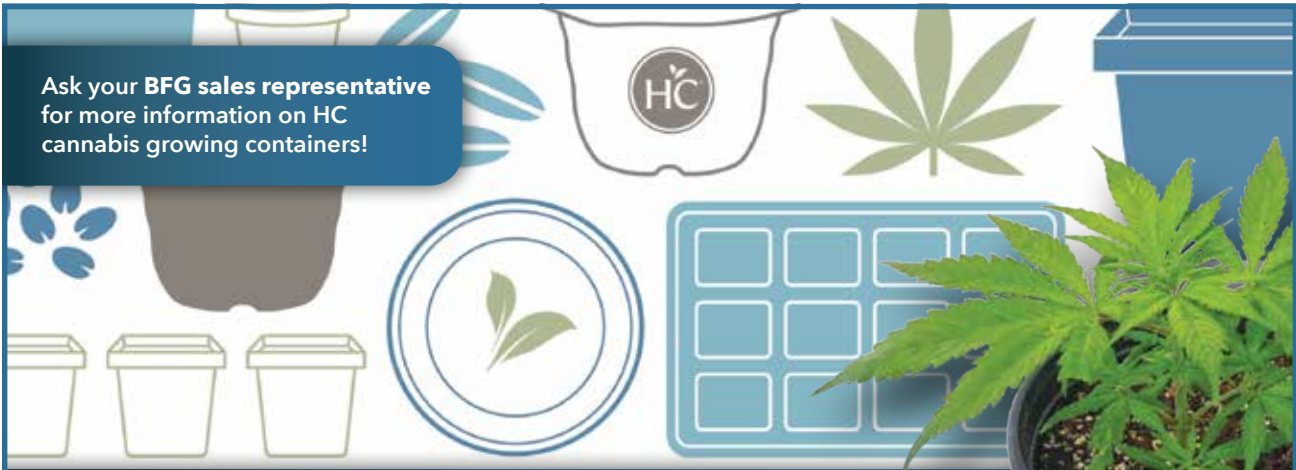

HC's start to finish containers for cannabis growers

- Our resin containers are beneficial to root systems
- Suitable for low- or high-density plantings both indoors and outdoors
- Cost-effective
- Available in many sizes, volumes, and sustainable options



800-225-7712 |

Sign up for our monthly e-newsletter!
hc-companies.com/newsletter

BROWSE BFG SUPPLY'S

vast product assortment
BFG offers more than just CEA/Hydro items!

TO BROWSE ALL ADDITIONAL CATEGORIES AND ITEMS AVAILABLE
please see our full catalog lineup or visit www.bfgsupply.com today!

SCAN NOW



A young green plant with several leaves is growing out of dark, rich soil. The plant is positioned in the upper right quadrant of the frame. A large, gold-colored diamond shape is superimposed over the image, with its center containing the text. The diamond's lines are thick and have a slight gradient, giving it a three-dimensional appearance. The background is a soft, out-of-focus white, suggesting a bright, natural light source.

PLANT

Supports

Gardener Select

Bamboo Supply Company

Stakes

Gardener Select® Green Vinyl Steel Stake

Strong and long lasting. Features steel core for strength, thick plastic coating that makes them weather and rust proof and a knobby surface for easy grip and handling. 10mm diameter.



2ft
GSA085620
 UPC 049121189546
 Min Buy 20 EA

3ft
GSA085920
 UPC 049121189553
 Min Buy 20 EA

4ft
GSA0851220
 UPC 049121189560
 Min Buy 20 EA

5ft
GSA101530
 UPC 049121189577
 Min Buy 20 EA

6ft
GSA101830
 UPC 049121189584
 Min Buy 20 EA



6ft Heavy Duty
GSA201830
 UPC 049121189591
 Min Buy 10 EA

7ft Heavy Duty
GSA202140
 UPC 049121189607
 Min Buy 10 EA

8ft Heavy Duty
GSA202440
 UPC 049121189614
 Min Buy 10 EA

Stakes

Bamboo Supply® Green Bamboo Stake

High-Quality all-natural stakes used for many things including plant support. Poles are dyed forest green to blend into landscapes.



18in, 4-6mm Diam. (1,000/BD)
BAMBBG01504
 Min Buy 1 BD

2ft, 4-6mm Diam. (1,000/BD)
BAMBBG0204
 Min Buy 1 BD

3ft, 4-6mm Diam. (1,000/BD)
BAMBBG0306
 Min Buy 1 BD

4ft, 8-10mm Diam. (500/BD)
BAMBBG0408
 Min Buy 1 BD



Bamboo Supply® Natural Bamboo Stake

High Quality all natural stakes used for many things including plant support.



2ft, 6-8mm Diam. (1,000/BD)
BAMBBN0206
 Min Buy 1 BD

2.5ft, 8-10mm Diam. (500/BD)
BAMBBN02508
 Min Buy 1 BD

3ft, 8-10mm Diam. (500/BD)
BAMBBN0308
 Min Buy 1 BD

3ft, 12-14mm Diam. (250/BD)
BAMBBN0312
 Min Buy 1 BD

4ft, 8-10mm Diam. (500/BD)
BAMBBN0408
 Min Buy 1 BD

4ft, 10-12mm Diam. (250/BD)
BAMBBN0410
 Min Buy 1 BD



4ft, 12-14mm Diam. (250/BD)
BAMBBN0412
 Min Buy 1 BD

6ft, 12-14mm Diam. (200/BD)
BAMBBN0612
 Min Buy 1 BD

6ft, 15-17mm Diam. (100/BD)
BAMBBN0615
 Min Buy 1 BD

6ft, 18-20mm Diam. (100/BD)
BAMBBN0618
 Min Buy 1 BD

8ft, 24-26mm Diam. (50/BD)
BAMBBN0824
 UPC 038417612066
 Min Buy 1 BD

Midwest Wire Works

Clips, Ties & Cages

Midwest Wire Mega Monster Tomato Cage

Supports your tomatoes promoting growth and helping the fruits stay healthy and off the ground.



Green - 72in
MWW4725XXXG
 UPC 850238006110
 Min Buy 4 EA

TENAX®

Netting

Tenax® Hortonova® Trellis Net

Polypropylene mesh that has revolutionized the climbing vegetable cultivation system! Tenax® Hortonova® Trellis Net has replaced metal meshes & iron trellises as a cost-effective solution for horticulture and floriculture support. It is lightweight but highly resistant. Its white color contrasts with your plants for a more comfortable and safer harvesting, trimming and stem cutting. Ideal for hydroponic systems, flower beds, gardens, and flowering plants.



36in W x 3280ft L

LWA58036607US

UPC 010515366072

Min Buy 1 EA

48in W x 8ft L

LWA2A150057

UPC 010515300830

Min Buy 20 EA

48in W x 16ft L

LWA2A150058

UPC 010515300847

Min Buy 18 EA

48in W x 50ft L

LWA2A150059

UPC 010515300854

Min Buy 8 EA

48in W x 3280ft L

LWA58036609US

UPC 010515366096

Min Buy 1 EA

79in W x 15ft L

LWA57603440

UPC 010515034407

Min Buy 18 EA

79in W x 30ft L

LWA57603492

UPC 010515034902

Min Buy 14 EA

79in W x 50ft L

LWA2A150062

UPC 010515402053

Min Buy 8 EA



Tenax® Hortonova® White Trellis Net

A strong and versatile polypropylene mesh trellis designed for growers as a gentle and efficient plant support. Helps increase yields by providing greater exposure to sunlight and air circulation for climbing vegetables as well as a support for flowers. The design fully satisfies the requirements of a variety of growing techniques, both vertical and horizontal.



59in W x 328ft L

LWA58019110

UPC 010515191100

Min Buy 1 EA

59in W x 3280ft L

LWA58012510US

UPC 010515125105

Min Buy 1 EA

67in W x 328ft L

LWA2A110097

UPC 010515100973

Min Buy 1 EA

67in W x 3280ft L

LWA58012511US

UPC 010515125112

Min Buy 1 EA

79in W x 100ft L

LWA2A150063

UPC 010515402060

Min Buy 6 EA

79in W x 250ft L

LWA2A110103

UPC 010515101031

Min Buy 1 EA

79in W x 3280ft L

LWA58012513US

UPC 010515125136

Min Buy 1 EA

120in W x 1500ft L

LWA1A170310

UPC 010515703105

Min Buy 1 EA





garden accessories



Clips, Ties & Cages

Panacea™ 4-Panel Heavy-Duty Tomato Tower

Exterior, powder coated, coated galvanized wire construction.



Red - 47in H - 4 Panels

PAN89764

UPC 093432897645

Min Buy 10 EA

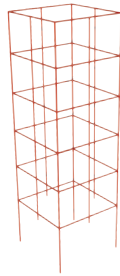

Panacea™ Tomato Cage

Galvanized wire tomato cages. Great for supporting peppers, eggplants and other tall garden and flowering plants too! Made in the U.S.A.



Galvanized - 12in Diam x 33in H - 3 Rings x 3 Legs

PAN89723

UPC 093432897232

Min Buy 25 EA

Galvanized - 12in Diam x 42in H - 3 Rings x 3 Legs

PAN89724

UPC 093432897249

Min Buy 25 EA

Galvanized - 14in Diam x 42in H - 4 Rings x 3 Legs

PAN89729

UPC 093432897294

Min Buy 25 EA

Galvanized - 16in Diam x 54in H - 4 Rings x 4 Legs

PAN89726

UPC 093432897263

Min Buy 25 EA



Panacea™ Tomato Cage Pallet

Contains the following - 50 of PAN89771 Panacea 42in Red Tomato Cage 3 Leg 3 Ring, 50 of PAN89772 Panacea 42in Green Tomato Cage 3 Leg 3 Ring, 50 of PAN89773 Panacea 42in Yellow Tomato Cage 3 Leg 3 Ring, and 50 PAN89774 Panacea 42in Blue Tomato Cage 3 Leg 3 Ring.



Multi Colored - 200Pc - 42In

PAN89901

UPC 093432899014

Min Buy 1 DS



Clips, Ties & Cages

Bond® Plastic Coated Twist Tie

Ideal for tying plants, vegetables and vines. Plastic coated, durable, flexible and strong.



66ft Roll

BON1160

UPC 034613011603

Min Buy 10 EA

160ft

BON1161PDQ

UPC 034613011610

Min Buy 12 EA



Bond® Stretch Tie Tape

Sturdy, strong and durable stretch tie expands with growth of plant. Ideal for flowers, vines, tomatoes and vegetable plants.



0.5in W x 150ft L

BON1150PDQ

UPC 034613011504

Min Buy 20 EA

1in W x 150ft L

BON1151PDQ

UPC 034613011511

Min Buy 10 EA

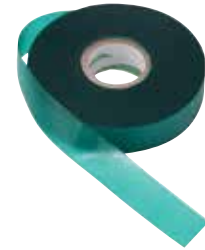

Clips, Ties & Cages

Engineered Essentials Plant Benders

Plant Benders are used to spread open a plants canopy. It allows deeper light penetration down into the canopy, greater airflow throughout the plant and allows direct branch control - make those stems grow in the direction you want! Replaces the need for strings and ties - no more drilling into pots!



Orange - Small (30pk)

ENE1000

UPC 860005100217

Min Buy 1 EA

Orange - Large (30pk)

ENE1001

UPC 860005100200

Min Buy 1 EA





Clips, Ties & Cages

Cedar Ridge Square Foldable Tomato Cage

The perfect tool to help your tomato plants thrive! No assembly necessary, just unfold, insert into the ground and watch your tomatoes grow. In addition, these tomato cages are designed to be row cover friendly, minimizing rips and frustration. These cages are perfect for the weekend gardener or the fulltime produce farmer.



48in H - Flat Size: 0.75in x 27in x 48in H,

Open Size: 13.25in x 13in x 48in H

CDR1348

UPC 748252705006

Min Buy 10 EA

56in H - Flat Size: 0.75in x 27in x 56in H,

Open Size: 13.25in x 13in x 56in H

CDR1356

UPC 748252704900

Min Buy 10 EA

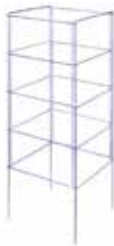

Clips, Ties & Cages

Luster Leaf® Link-Ups® Grow Through Grid Plant Support

Gathers and supports heavy plants that have trouble standing up on their own.



Round - 20in Grid x 30in Leg

LUS973

UPC 035307009739

Min Buy 12 EA



Luster Leaf® Rapiclip® Light Duty Soft Wire Tie

Multi-purpose cushioned wire tie for countless home and garden uses. Great for supporting saplings and young or recently transplanted trees.



16ft

LUS839

UPC 035307008398

Min Buy 12 EA



Luster Leaf® Rapiclip® Plant Twist Ties

Plastic coated wire in holder with cutter.



100ft

LUS841

UPC 035307008411

Min Buy 12 EA



Netting

Gardeneer by Dalen® Trellis Netting

Heavy-duty, tangle-free nylon netting is ideal for growing tomatoes, peas, and vining crops. Harvesting is easy with the 7in reach-through mesh.



5ft x 15ft

DALTP15C

UPC 016069000059

Min Buy 12 EA

5ft x 30ft

DALTP30C

UPC 016069000196

Min Buy 12 EA



Clips, Ties & Cages

Velcro® One-Wrap® Plant Ties

Unique back to back fastener.



Green - 0.5in W x 50ft L

VEL30071USA

UPC 075967300715

Min Buy 6 EA



Low Stress Plant Training Kit

Patent Pending

30 PACK



Reusable: Everlasting design allows for continuous use harvest after harvest.

30 Pack: One pack will provide huge amounts of Low Stress Training potential up to 3 plants.

Increases Airflow: Air flow plays an important roll in preventing mold. These Low Stress Trainers allow the plant to be re-oriented and allow for better airflow, preventing the chance for mold to grow.

Direct Plant Direction: Stems can be reoriented in any direction including side-to-side to remove shade casted onto lower parts of the plant.



Increase Light Penetration throughout canopy: By directing stems and budding sites outward, more light is able to reach the center of the plants and hit photosensitive areas which will increase growth.

**NO MORE DRILLING INTO POTS!
INSTALLS IN SECONDS!
BENEFITS ALL TYPES OF PLANTS!**

CHECK OUT OUR ADJUSTABLE VERSION!

SCAN THE QR CODE BELOW FOR AN INSTALL VIDEO!

www.EngineeredEssentials.com

 Tag us on Instagram @EngineeredEssentials



Orange - Small (30pk)
ENE1000
Orange - Large (30pk)
ENE1001

**ENGINEERED
ESSENTIALS**



METERS &
Lesters

BlueLab

Meters

BlueLab Truncheon® Nutrient Meter V2

Displaying all the conductivity scales EC, CF, PPM 500 & PPM 700 on a single line. Each time you feed your plants it's essential to know the nutrient levels of your solution. Simply done with the BlueLab Truncheon Nutrient Meter. Flashing lights indicate your conductivity reading, which is automatically compensated with the integrated temperature sensor. Removable shroud for easy cleaning. It features a conductivity range up to 3.6 EC, 36 CF, 1800 ppm 500 and 2520 ppm 700 and is fully waterproof. Provided with EC, CF, ppm 700 and ppm 500 scales. Includes an auto on/off function with no calibration required (factory calibrated). Daylight readable blue LEDs, visible in bright or dark environments with no buttons or switches. Battery operated (3x AA batteries included). Measure while mixing nutrients in your reservoir.



40cm L / 16 in. L

BLBTRUNV2

UPC 942102492001

Min Buy 1 EA



BlueLab® Carry Case

Protect your BlueLab® meter and enjoy hands-free readings and storage. Firm outer casing for impact resistance, two custom pockets for holding BlueLab® probes, strong nylon strap with adjustable length and a 'D' hook at the top for easy hanging.



BLBMETCARRYCASE

UPC 9421024920494

Min Buy 1 EA



BlueLab® Combo Meter

A convenient and portable solution pH, conductivity, and temperature meter all in one. Easy to read screen and push button operation, choose your preferred parameter to display. Portable with no external power supply required, this meter can be used anytime and anywhere to help manage your plants daily nutrient requirements. Features replaceable double junction pH probe. Shows conductivity scales CF, EC, PPM 500 & PPM 700 at the touch of a button. Large easy to read, backlit LCD display. No calibration required for conductivity and temperature (factory calibrated). Simple two point pH calibration process with 30 day calibration indicator. Includes over range and under range indicators, low battery indicator and auto off function. 2x AAA alkaline batteries included. Team with BlueLab® solutions and the convenient BlueLab® Carry Case.



Probe Cable: 2meters L / 6.5ft L

BLBMETCOM

UPC 942102492003

Min Buy 1 EA



BlueLab® Combo Meter pH Replacement Probe

Dependable double-junction pH probe technology that's built to last. Double-junction probe reduces reference contamination, extending longevity. Fast sensor response ensures quick and accurate measurements. Effective in solutions of 0.2 EC and above.



pH probe

BLBPROBPH

UPC 942102492004

Min Buy 1 EA



BlueLab® Combo Meter Plus

A convenient and portable solution pH, conductivity, and temperature meter all in one. Easy to read screen and push button operation, choose your preferred parameter to display. Portable with no external power supply required, this meter can be used anytime and anywhere to help manage your plants daily nutrient requirements. Features replaceable double junction pH probe. Shows conductivity scales CF, EC, PPM 500 & PPM 700 at the touch of a button. Large easy to read, backlit LCD display. No calibration required for conductivity and temperature (factory calibrated). Simple two point pH calibration process with 30 day calibration indicator. Includes over range and under range indicators, low battery indicator and auto off function. 2x AAA alkaline batteries included. Team with BlueLab® solutions and the convenient BlueLab® Carry Case.



BLBMETCOMPLUS

UPC 942102492097

Min Buy 1 EA



BlueLab® Leap pH Probe

An all-in-one, convenient portable solution for accurate measurement of pH, conductivity and temperature in nutrient solution. The battery-powered, lightweight and portable unit can be used anywhere, anytime to measure critical parameters related to nutrient uptake in plants. The BlueLab® Leap pH probe also allows fast and accurate pH measurements direct from the rootzone in a wide range of growing media including soil, rockwool, coco coir and potting mixes - no more pH slurries or extraction mixes. The detachable BlueLab® Leap pH Probe has a double junction, toughened spear-tip for improved durability and is lightning fast in nutrient solution. Easy to read backlit screen for lowlight environments, and simple push button operation to view your chosen parameter. Features pH, conductivity and temperature measured with corded probes. Includes robust electrical conductivity probe with integrated temperature sensor. Conductivity scale options: EC, CF, PPM500, PPM700, viewed at the touch of a button. Simple two-point pH calibration with 30-day calibration indicator. Over-range and under-range indicators as well as a low battery indicator. Features auto-off function and 2x AAA alkaline batteries included. Team with the BlueLab® Carry Case and BlueLab® care and calibration solutions for optimal performance.



BLBPROBPHLEAP

UPC 942102492094

Min Buy 1 EA



BlueLab

Meters

BlueLab® Commercial Truncheon Nutrient Meter

An EC meter built to last a lifetime, now on a bigger scale. Robust and reliable construction for long-lasting value. Automatically detects liquids and bright LEDs indicate measurement for brilliantly simple functionality. Long-format design for mixing and measuring nutrient reservoirs simultaneously. No calibration required and easy to clean and disinfect. All conductivity scales included: EC, CF, PPM 500 (TDS), PPM 700.



BLBTRUNCOMV2

UPC 9421024920111

Min Buy 1 EA



BlueLab® Conductivity Pen

The go-to for hand held conductivity pens. The BlueLab® Conductivity Pen simply tells you the amount of nutrient in your solution. Conductivity is automatically compensated with the integrated temperature sensor. Providing a compact, quick and accurate way to measure two key parameters for crop health. Teamed with our BlueLab® pH Pen you have a robust, convenient and accurate measurement system. It Measures conductivity and temperature with selectable units for conductivity and temperature. Shows conductivity scales CF, EC, PPM 500 & PPM 700 at the touch of a button and is fully waterproof. It has a backlit LCD display. Calibration optional with successful 30 day calibration indicator. Hold reading function and low battery indicator. Includes auto off function and automatic temperature compensation. 1x AAA replaceable battery included.



BLBPENCON

UPC 942102492027

Min Buy 1 EA



BlueLab® Connect™ Range Extender

Simply plug the BlueLab® Connect™ Range Extender into a power supply between BlueLab® Connect™ Devices and BlueLab® Connect™ Stick to increase the signal. For extra-long distances multiple BlueLab® Connect™ Range Extenders can be used. Features an International Power Supply (may differ from image shown). Installation instructions included.



BLBCONEXTEND

UPC 9421024920609

Min Buy 1 EA



BlueLab® Connect™ Stick

Collects information wirelessly from BlueLab® Connect™ devices to your computer. One BlueLab® Connect™ Stick receives data wirelessly from multiple BlueLab® Connect™ devices. Download the free BlueLab® Connect™ software to get grow site data direct to your local computer and mobile app.



BLBCONSTICK

UPC 9421024920593

Min Buy 1 EA



BlueLab® Guardian Monitor

Monitoring your crops 24 hours a day, with the ability to set high and low alarms for each parameter. A flashing display lets you know if your parameters move away from the optimum, allowing you to make the important adjustments quickly and effectively. The large, clear display allows readings to be viewed from a distance. The BlueLab® Guardian Monitor is mains powered and is either mounted to the wall or hung on a support and probes positioned inside your reservoir / solution. It features a wall mount for continuous viewing, Plant-safe green LEDs, with adjustable brightness, and large easy to read displays. A replaceable double junction pH probe is included. Easy to navigate menu to program and adjust settings. Selectable conductivity and temperature scales with no calibration required for conductivity and temperature. Features simple push button pH calibration. Includes flashing high and low alarms (non-audible). It is built with greater tolerance to RF / electronic interference. Features international power supply and non-volatile memory.



Probe Cable: 2meters L / 6.5ft L

BLBMONGUA

UPC 942102492008

Min Buy 1 EA



BlueLab® Guardian Monitor Connect

A constant indicator of pH, conductivity and temperature, enabling you to optimise these parameters. Monitor and wirelessly data log the essential nutrient solution parameters - pH, conductivity and temperature - when teamed up with a BlueLab® Connect™ Stick and local computer. Keeping track of the growth history on your computer will give you the blueprint for crop success again and again. Guard your results by setting a high and low alarm range in each parameter and receive digital notification if the solutions move outside the alarm ranges set. It features a wall mount for continuous viewing. Remote viewing with BlueLab® Connect™ Software and Apps is available. Replaceable double junction pH probe is included. Bright, plant-safe green LED with adjustable brightness and easy to navigate menu to program and adjust settings. Selectable conductivity and temperature scales. No calibration required for conductivity and temperature (factory calibrated). Simple push button pH calibration. Flashing high and low alarms (non-audible), built with greater tolerance to RF / electronic interference, international power supply.



Probe Cable: 2meters L / 6.5ft L

BLBMONGUAACON

UPC 942102492058

Min Buy 1 EA



Bluelab

Meters

Bluelab® Guardian Monitor In-Line Connect

Threaded probe heads allow for simple installation direct into an irrigation line for effective in-line measurements. Suitable for use before or after mechanical injectors. Both conductivity and pH probes can screw directly into female 1in NPT pipe fittings using the included adapter. Teamed with the Bluelab® Connect™ Stick, you get all the convenience of wireless data logging and remote alerts. Features pH and EC in-line threaded probes to fit into in-line plumbing. Remote viewing with Bluelab® Connect™ Software and Apps. It includes a replaceable double junction high pressure pH probe. Also, has a bright, plant-safe green LED with adjustable brightness. Easy to navigate menu to program and adjust settings. Selectable conductivity and temperature scales with simple push button pH calibration. No calibration required for conductivity and temperature (factory calibrated). Flashing high and low alarms (non-audible). Built with greater tolerance to RF/electronic interference. It features an international power supply.



In-line pH probe cable: 3 meters L / 10 ft L
BLBMONGUACONIN

UPC 942102492080
Min Buy 1 EA



Bluelab® Multimedia pH Meter

Combine the Bluelab® Multimedia pH Meter and Bluelab® Leap pH Probe to take fast accurate measurements in nutrient solution, soil, coco coir, rockwool, potting mix and many other media types. Calibration is simple with one push button on the meter and fresh Bluelab® Calibration Solutions. Successful calibration indicator is displayed on screen for 30 days to indicate when re-calibration is required. Team with the Bluelab® Solutions and the convenient Bluelab® Carry Case. Replacement Bluelab® pH or Leap pH Probe available too. Test more with a faster sensor response and direct measurements from substrates. Multimedia friendly, for measurements across a range of environments. Toughened spear tip for direct root-zone measurements. Simple two point calibration process with 30 day calibration indicator. Backlit LCD display, low battery indicator, auto off function.



Standard Cable: 2 meters L / 6.6 ft L
BLBMETMULTI

UPC 942102492095
Min Buy 1 EA



Bluelab® pH Controller

Fine-tunes the reservoir pH levels for you. Confidence - your pH is taken care of. Automatic measuring and adjusting to pre-set pH levels with optional alarms. Provides consistent control of pH in growing systems. Intuitive "on time" and "off time" allows the solution to dose and mix before the controller measures and doses again. Reassurance with safety lockouts to prevent over delivery of pH. Automatic control of pH level in systems with reservoirs up to 200gal / 760L. Dose either pH up or pH down adjusters. Replaceable double junction pH probe and peristaltic pump. Plant-safe green backlit LCD with adjustable brightness. Large, easy to read display with easy to navigate menu to adjust settings. Simple push button pH calibration with on screen instructions. Flashing high and low alarms with control lockouts. Water resistant, wall mount design with separate Bluelab® Temperature Probe (for pH ATC).



Probe Cable: 2meters L / 6.5ft L
BLBCONTPH

UPC 942102492067
Min Buy 1 EA



Bluelab® pH Controller Connect pH Control 24/7

The fuss-free Bluelab pH Controller Connect will enable you to continuously maintain perfect pH levels in your reservoir, allowing you to walk away with complete peace of mind knowing that your crops are in safe hands. That's because the Bluelab pH Controller Connect will automatically dose your reservoir 24/7 to ensure that key nutrients are soluble and therefore available to your plants at all times, creating the conditions for ideal nutrient uptake. Forget spot checks and manual adjustments – now you can effortlessly enjoy thriving plant health and save thousands of hours without compromising on quality.



BLBCONTPHCON
UPC 9421024920685

Min Buy 1 EA



Bluelab® pH Probe Inline

A replaceable double-junction pH probe for your Bluelab Guardian Monitor Connect Inline. Double-junction probe reduces reference contamination, extending longevity. Fully waterproof, fast sensor response ensures quick and easy accurate measurements and a 3 metre cable for measuring in hard to reach locations. Effective in solutions of 0.2 EC and above.



3/4in NPT Thread, Use with 1in Adapter
BLBPROBPHIN

UPC 9421024920890
Min Buy 1 EA



BlueLab

Meters

BlueLab® pH Pen

The preferred option for hand held pH meters. It provides a compact, quick and handy way to manage the success of your crops to ensure maximum uptake of nutrients. A key parameter that affects nutrient uptake is whether your solution is acid or alkaline. This is measured in the pH. Teamed with the BlueLab™ Conductivity Pen you have a robust, convenient and accurate measurement system. It measures pH and temperature. Includes selectable units for temperature. Is fully waterproof. It has a backlit LCD display and a double junction probe (not replaceable). Simple two point calibration process with 30 day calibration indicator. Features hold reading function, low battery indicator and auto off function. Includes automatic temperature compensation and 1 AAA replaceable battery.



BLBPENPH

UPC 942102492023

Min Buy 1 EA

BlueLab® Probe Care Kit - Conductivity

Everything you need to clean and maintain your conductivity probes. Kit includes: instructions, two 20 ml single-use sachets of BlueLab 2.77 EC conductivity standard solution, one plastic cup, probe cleaner, and chamois for cleaning.



BLBCAREKITCON

UPC 9421024920579

Min Buy 1 EA

BlueLab® Probe Care Kit - pH

Everything you need to clean, calibrate and maintain your pH probes. Kit includes: instructions, 20 ml single-use BlueLab Solution Sachets - two each of: pH 7.0, pH 4.0 and KCl solutions, three plastic cups, probe cleaner, and toothbrush for cleaning.



BLBCAREKITPH

UPC 9421024920623

Min Buy 1 EA

BlueLab® Probe Care Kit - pH and Conductivity

Everything you need to clean, calibrate and maintain your pH and conductivity probes. Kit includes: instructions, 20 ml single-use BlueLab Solution Sachets - two each of: pH 7.0, pH 4.0, KCl and 2.77 EC standard solution, pH and conductivity probe cleaner, three plastic cups, toothbrush for cleaning the pH probe and chamois for cleaning the conductivity probe.



BLBCAREKITPHCONL

UPC 9421024920562

Min Buy 1 EA

Solutions

BlueLab® Pulse Multimedia EC/MC Meter

Introducing Pulse, a new innovation designed and made in NZ by BlueLab®. The first of its kind in a range that connects directly to your mobile device. Simply and easily spot check moisture, conductivity (a measure of the nutrient salts present in the media) and temperature directly from the root zone, or nutrient solution to allow early identification of results over or under range. Spot check, correct, achieve better yield and grow healthier plants across a wide range of growing media including soil, coco coir, potting mix and nutrient solution. Quickly and easily check multiple plants in one greenhouse. Automatically sends and stores all your key plant statistics in the Pulse Mobile App. No requirement to connect to a computer. All in one device that measures moisture content, conductivity and temperature. Features quick reference visual light indicator on the device to let you know the measurement has been made and if it is in or out of range as well as a vibrating notification on the mobile device to let you know that measurement was received. Able to test more in a shorter timeframe with a fast sensor response and direct measurements in a wide range of growing media including soil, nutrient solution, coco coir and potting mix. Two extended prong spear tips with a total of 8in / 200 mm including the 2in / 50 mm active measurement tips for direct root zone measurements. Handset measures 7.5in / 190 mm x 3in / 76 mm. Includes low battery indicator. 1x AA alkaline battery included. Applications across agriculture, floriculture, container grown plants and greenhouses. Works with Android 5.1+ with Bluetooth 4.0+.



BLBMETPULSE

UPC 942102492098

Min Buy 1 EA

BlueLab® 2.77EC Conductivity Standard Solution

BlueLab® conductivity standard solutions are essential for use with all BlueLab® products. BlueLab® Solutions are manufactured specifically for BlueLab® products and are referenced to high laboratory standards to ensure your BlueLab® products last longer and maintain accuracy.



250ml

BLBEC277250BL

UPC 942102492029

Min Buy 6 EA

500ml

BLBEC277500BL

UPC 942102492032

Min Buy 6 EA



BlueLab

Solutions

BlueLab® 4.0 Calibration Solutions

Calibration and conductivity standard solutions – a must in every grower's toolbox. The BlueLab® calibration and conductivity standard solutions are essential for use with all BlueLab® products. BlueLab® solutions are manufactured specifically for BlueLab® products and are referenced to high laboratory standards to ensure your BlueLab® products last longer and maintain accuracy.



250ml

BLBPH4250BL

UPC 942102492028

Min Buy 6 EA

500ml

BLBPH4500BL

UPC 942102492031

Min Buy 6 EA



BlueLab® 7.0 Calibration Solutions

Calibration and conductivity standard solutions – a must in every grower's toolbox. The BlueLab® calibration and conductivity standard solutions are essential for use with all BlueLab® products. BlueLab® solutions are manufactured specifically for BlueLab® products and are referenced to high laboratory standards to ensure your BlueLab® products last longer and maintain accuracy.



250ml

BLBPH7250BL

UPC 942102492027

Min Buy 6 EA

500ml

BLBPH7500BL

UPC 942102492030

Min Buy 6 EA



BlueLab® pH Probe KCl Storage Solution

The perfect solution to store and hydrate pH probes. pH probes are sensitive glass instruments which age through everyday use. BlueLab® pH Probe KCl Storage Solution is made specifically for use with BlueLab® pH Probes and Pens. It is designed to increase response time and maximize the life of BlueLab® pH Pens and pH Probes. Add KCl solution to the cap of the pH pen/probe for storage after use and hydrate in KCl solution monthly. Instructions are on the label of the bottle.



120ml

BLBSTOL120BL

UPC 9421024921415

Min Buy 6 EA

250ml

BLBSTOL250BL

UPC 942102492086

Min Buy 6 EA



Meters

Hanna® Alkalinity Test Kit

A chemical test kit that measures alkalinity by titration with hydrochloric acid. This item supplied complete with all of the reagents and equipment necessary to perform approximately 110 tests. Pre-made reagents for ease of use. Reagents marked with expiration date and lot number for traceability.



HIH13811

Min Buy 1 EA



Hanna® Combo pH/Conductivity/TDS Tester

A highly accurate, waterproof combo pH ec tester that can also measure EC/TDS in the high range (0.00 to 20.00 mS/cm EC/ 0.00 to 10.00 ppt TDS) and temperature. This floating, waterproof combination tester has an easy to read, LCD and an automatic shut-off. In addition, pH and EC/TDS readings are automatically temperature compensated (ATC) to prevent temperature-related variations in your measurements. For EC/TDS readings, the EC/TDS conversion factor (CONV) is selectable by the user, as well as the temperature compensation coefficient (BETA).



High Range

HI98130

Min Buy 1 EA





Meters

Hanna® pH / EC / TDS Tester

A waterproof tester that offers high accuracy pH, EC/TDS and temperature measurements in a single tester! No more switching between meters for your routine measurements. This floating, waterproof combination tester has an easy to read, LCD and an automatic shut-off. pH and EC/TDS readings are automatically temperature compensated. Includes: HI 73127 pH electrode and HI 73128 electrode removal tool, batteries and instructions.



HI98130

Min Buy 1 EA



Solutions

Hanna® 4.01 pH Buffer Solution

Solution is prepared according to precise formulas and is standardized with a pH meter calibrated according to the NIST standards. Batch number, expiration date and correlation table between pH and temperature included.



500ml

HI7004L

Min Buy 1 BT



Hanna® 7.01 pH Buffer Solution

pH 7.01 is the most widely used among all buffer solutions. Solution is NIST standardized.



500ml

HI7007L

Min Buy 1 BT



Hanna® EC Solution

The 1413 $\mu\text{S}/\text{cm}$ calibration solution is best suited for general use. This solution is also available in combined kits with HANNA® pH 7 buffer for easy calibration of multiparameter instruments.



1,413 $\mu\text{S}/\text{cm}$

HI7031L

Min Buy 1 BT



Solutions

Hanna® Electrode Storage Solution

To minimize clogging and ensure fast response time, always keep the glass bulb and the junction of your pH electrode moist. Store the electrode with a few drops of HI 70300 storage or pH 7 buffer solution in the protective cap.



HI70300L

Min Buy 1 BT



Hanna® General Purpose Cleaning Solution

HI7061M is a general purpose cleaning solution that can be used for a variety of applications. Electrodes can become dirty from use and will produce inaccurate results even as they read correctly in a pH buffer. Hanna's™ cleaning solutions eliminate impurities and residues that are left on electrode surfaces when immersed in samples during measurement or when stored incorrectly. Hanna suggests cleaning the bulb and junction of your electrode on a regular basis to ensure that the probe is always clean and to prevent any clogging of the junction.



230ml

HI7061M

Min Buy 1 BT



Hanna® pH Electrode Storage Solution

An electrode storage solution prepared with reagent grade chemicals that can be used to ensure optimum performance of your pH and ORP electrodes. Properly storing your pH electrode in a solution keeps the glass membrane well hydrated which maintains proper function and provides accurate readings. Special formulation to minimize bacterial growth on your electrode. Clearly marked expiration date and lot number for traceability. Designed for storing any pH or ORP electrode.



230ml

HI70300M

Min Buy 1 EA



Hanna® Quick Calibration Solution for GroLine pH and EC Meters

A quick calibration solution for use with Hanna's™ GroLine pH and/or EC/TDS meters. Using the Quick Cal function found in compatible meters allows for a single point calibration for pH and/or conductivity sensors.



HI50036P

Min Buy 1 EA





Meters

Eco HM Digital EC Tester

Eco HM digital EC meter for testing and monitoring to receive the desired results. Easily measure conductivity and TDS.



6in x 1.7in x .7in

DILCOM80

Min Buy 1 EA



Solutions

HM Digital/EC Calibration Solution

NaCl calibration solution that comes in a lightweight HDPE plastic bottle. Sealed with a coated foam liner. For optimized calibration. Works with both ECO and PRO models.



1000 PPM

DILC1000

Min Buy 1 EA

**Eco HM Digital pH Tester**

Eco HM digital pH tester for testing and monitoring to receive the desired results. Easily measure conductivity, pH, and temperature of water.



6in x 1.7in x .7in

DILPH80

Min Buy 1 EA

**EC Calibration Solution**

EC Calibration Solution works with both ECO and PRO models. Includes individual liquid calibration packets and ready-to-use.



20pc Box

DILCP1000

Min Buy 1 EA

**HM Digital Meter**

Pro HM digital EC meter for measuring conductivity, TDS, temperature of water.



7.3in x 1.3in x 1.3in

DILCOM100

Min Buy 1 EA

**PH Calibration Solution**

PH Calibration and storage solution works with both ECO and PRO models. Includes individual liquid calibration packets and ready-to-use.



20pcs

DILPHP7

Min Buy 1 EA

**Pro HM Digital pH Meter**

Pro HM digital pH meter for testing and monitoring to receive the desired results. Easily measure pH and temperature of water.



7.3in x 1.3in x 1.3in

DILPH200

Min Buy 1 EA

**PH Storage Solution**

PH storage solution that keeps probe balanced, contains fungicide, helps probe last longer and works with both ECO and PRO models.



60cc

DILPHSTOR

Min Buy 1 EA





Meters

Luster Leaf® Digital Soil Thermometer

Improves seeding and transplanting results by planting at the safe and proper soil temperature. Easy to read digital results. Scaled specifically for soil temperature readings in Fahrenheit. Stainless steel probe. Guidelines for germination and transplant temperatures included. Batteries included.



LUS1625
UPC 035307016256
Min Buy 6 EA



Luster Leaf® Rapitest® pH & Moisture Tester

Signals soil moisture level. Indicates soil acidity/alkalinity. Includes watering needs for many plants. No batteries required.



LUS18176
UPC 035307018175
Min Buy 6 EA



Luster Leaf® Rapitest® Digital Moisture Meter

Instant and easy to read digital format. It checks soil moisture where it counts, at root level. Monitoring a plants soil moisture level helps prevent over and/or under watering. Batteries required and included.



LUS1825
UPC 035307018250
Min Buy 12 EA



Luster Leaf® Rapitest® Soil Test Kit

Determining whether your soil pH needs adjusting or if nitrogen, phosphorus and potash should be added in the form of fertilizers. Easy to use, just mix soil and water together, pour off solution into comparator, pour in the powder from the capsule, shake and compare to color chart.



Kit Contains 40 Tests - 10ea for pH, Nitrogen, Phosphorus & Potash.
LUS1601
UPC 035307016010
Min Buy 6 EA



Luster Leaf® Rapitest® Digital Soil pH Meter

Provides an easy to read, instant result, digital read-out. It measures and displays the acidity/alkalinity of garden and container soil. Batteries are required and included.



LUS1845
UPC 035307018458
Min Buy 12 EA



Luster Leaf® Rapitest® Electronic 4-Way Analyzer

Unique three probe design allows one meter to measure the essentials for plant growth: sunlight, soil pH, moisture and combined N-P-K levels. Compact portable meter measures the essentials for vigorous growth.



LUS1880
UPC 035307018809
Min Buy 3 EA



Luster Leaf® Rapitest® Soil pH Meter

Checks which plants suit your soil pH and tells you how to alter soil. A pH performance guide for more than 350 plants is included. Ideal for potted indoor and outdoor plants. Simple readout.



LUS1840
UPC 035307018403
Min Buy 6 EA



Luster Leaf® Rapitest® Electronic Soil Tester

Determines soil pH and fertility level. Both tests can be completed in about a minute. Requires one AA battery. Complete instructions include how to adjust pH and select appropriate fertilizers according to soil conditions.



LUS1860
UPC 035307018601
Min Buy 6 EA





Meters

Luster Leaf® Rapitest® pH Soil Tester

Ideal test to determine soil acidity/alkalinity. Particularly valuable for adjusting soil conditions for better growing lawns, shrubs, evergreens and plants. Just mix soil and water, pour off solution into comparator, add tablet, shake and compare to color chart. It's just that easy.



Contains 10 pH Tests

LUS1612

UPC 035307016126

Min Buy 12 EA

Luster Leaf® Rapitest® Digital 3-Way Analyzer

Measures soil pH, soil temperature and soil fertility. An easy and convenient method to check your soil with just a couple touches to the digital analyzer.



LUS1835

UPC 035307018359

Min Buy 3 EA



Luster Leaf® Rapitest® Digital Soil Test Kit

Quickly and easily tests soil samples measuring levels of pH, nitrogen, phosphorus, and potash.



3pk

LUS1605

UPC 035307016058

Min Buy 3 EA



EXPLOSIVE RESULTS

The best microbes produce the best plants. Highly concentrated, trusted by growers and proven. Mycorrhizae, beneficial bacteria and microbial nutrients. Give your plants what they want.

@greatwhitemyco
 PLANT
 REVOLUTION
 plantrevolution.com



LIGHTING



SPYDR Fang

SPYDR FANG is a high-performance top-lighting solution for small to medium sized horticulture cultivation environments. Command your grow with our efficiency optimized output, PhysioSpec™ Indoor spectrum, and integrated 0-100% dimming for easy control and full-cycle cultivation.

SPECIFICATIONS

Light Source	LED
Spectrum	PhysioSpec™ Broad R4
Light Output PPF	1600 µmol/s
Efficacy	2.5 µmol/J @ 120 V AC
AC Input Power	636 W @ 120 V AC
AC Input Voltage	120-277 V AC, 50/60 Hz
Light Distribution	120°
Mounting Height Above Canopy	6" - 12" [15-30 cm]
Thermal Management	Passive
Max. Ambient Temperature/Humidity	95°F [35°C], 90% RH
Dimming	Dimmer Module Included
Total Harmonic Distortion (THD)	<10% at 100% output
Lifetime (Driver and LED L90)	> 36,000 hrs
IP Rating IEC60598-1	IP66
Certifications	UL 8800, UL 1588, CE, IEC60598-1
Warranty	3 Year Limited Warranty

NOMINAL ELECTRICAL AC INPUT*

AC VOLTAGE	120 V	230/240 V	277 V
AC Current	5.32 A	2.79 A	2.34 A
AC Power	636 W	626 W	625 W
Power Factor	0.99	0.97	0.96

* At 77°F [25°C] ambient temperature and 100% output.

SPECTRA

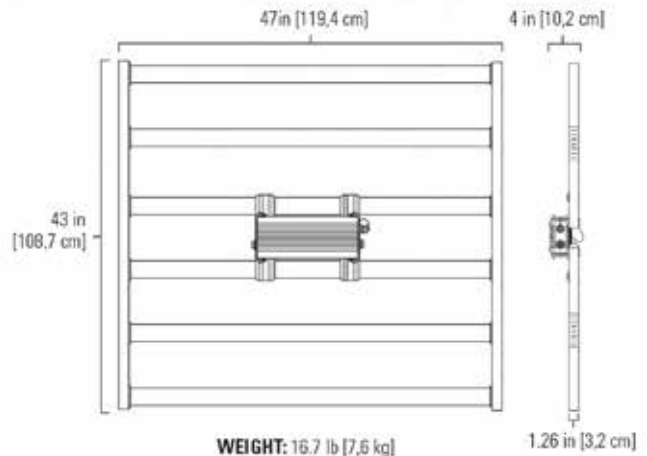
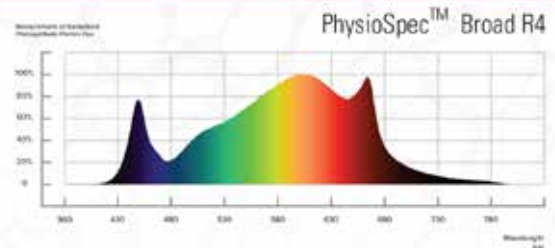

Please contact your BFG Sales Representative for pricing & availability.



LED

Fluence SPYDR 2i Top-Light

The SPYDR 2i is a high-performance top-lighting solution for commercial cannabis growers who want to push the envelope with high-PPFD cultivation practices and experimental applications or treatments.



PPF: 1700 $\mu\text{mol/s}$ - Efficacy: 2.7 $\mu\text{mol/J}$ - Input Power: 630W @277v
FLUSR2I100MSHS
 Min Buy 1 EA



PPF: 12500 $\mu\text{mol/s}$ - Efficacy: 2.48 $\mu\text{mol/J}$ - Input Power: 505W @277v
FLUSR2I33I100MSHS
 Min Buy 1 EA



Fluence SPYDR 2P Full Light

SPYDR 2p is designed for full-cycle, close-proximity cultivation in controlled environments and multi-tiered vertical applications where even one wasted inch is one too many.



PPF: 1550 $\mu\text{mol/s}$ - Efficacy: 2.5 $\mu\text{mol/J}$ - Input Power: 631W @277v
FLUSR2PI100MSHS
 Min Buy 1 EA



Fluence SPYDR 2X Full Light

SPYDR 2x is an early-development top-lighting solution for commercial cannabis cultivation, or a full-cycle top-lighting solution for home hobbyists cultivating without CO2 supplementation at ambient conditions around 400 ppm. SPYDR 2x is comparable to the previous generation's SPYDRx and delivers an average of 550 $\mu\text{mol/m}^2/\text{s}$ of highly-uniform light over a 4'x4' area at only 6" above canopy.



PPF: 750 $\mu\text{mol/s}$ - Efficacy: 2.4 $\mu\text{mol/J}$ - Input Power: 294W @277v
FLUSR2X33I100MSHS
 Min Buy 1 EA



PPF: 860 $\mu\text{mol/s}$ - Efficacy: 2.5 $\mu\text{mol/J}$ - Input Power: 345W @277v
FLUSR2XI100MSHS
 Min Buy 1 EA



Fluence VYPR 3P LED Grow Light

Featuring multiple spectra and high efficacy, the VYPR series is Fluence's advanced solution for greenhouse supplemental lighting and indoor sole-source applications. Built upon patented thermal management technologies, the latest VYPR top lights feature market-leading efficacies and high light output per fixture. Thus, helping reduce the fixture count and system cost per lit area to accelerate the adoption of LED horticulture lighting.



PPF: 1663 $\mu\text{mol/s}$ - Efficacy: 2.7 $\mu\text{mol/J}$
FLUVR3PBW3LVG0000003PSAR
 Min Buy 1 EA



Fluence AC Cord

Cable for Fluence SPYDR light.



6ft - NEMA 5-15P Connector - Pushlock Female 3Pin M19 Connector
FLUCACA7074810
 Min Buy 1 EA

15ft - NEMA 5-15P Connector - Pushlock Female 3Pin M19 Connector
FLUCACA7074905
 Min Buy 1 EA

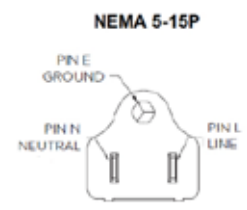

CACA-70749

Fluence AC Cord

Cable for Fluence SPYDR light.



6ft - NEMA 6-15P Connector - Pushlock Female 3Pin M19 Connector
FLUCACA7075010
 Min Buy 1 EA

15ft - NEMA 6-15P Connector - Pushlock Female 3Pin M19 Connector
FLUCACA7075105
 Min Buy 1 EA

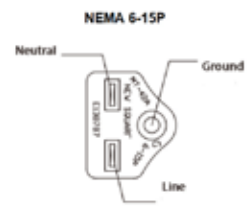

CACA-70751

Fluence AC Cord

Cable for Fluence SPYDR light.



6ft - PTP Pigtails Connector - Pushlock Female 3Pin M19 Connector
FLUCACA7075410
 Min Buy 1 EA

15ft - PTP Pigtails Connector - Pushlock Female 3Pin M19 Connector
FLUCACA7075505
 Min Buy 1 EA

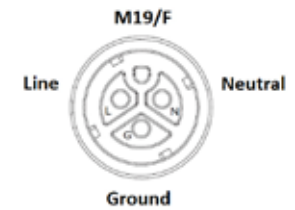

CACA-70755



LED

Fluence Mounting Hardware

Provides a two point mounting solution with 5ft of braided stainless steel wires and carabiners.



Adjustable Hanging Kit
FLUAMS21031010

Min Buy 1 EA

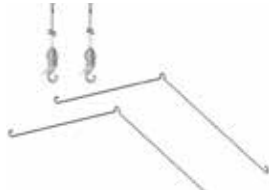

Fluence Mounting Hardware

Provides a two point mounting solution.



Lance Hangers
FLUAMS21033220

Min Buy 1 EA



Fluence Mounting Hardware

Provides a four point mounting solution for waterfall decking.



Short "V" Mounting Bracket
FLUAMS21033020

Min Buy 1 EA



Long "V" Mounting Bracket
FLUAMS21034820

Min Buy 1 EA

Fluence Mounting Hardware

Provides a four point mounting solution that's ideal for levels solid decking in rolling tables.



Solid Decking Mounting Bracket
FLUAMS21033120

Min Buy 1 EA



Fluence DC Cord Extension

Cable for Fluence SPYDER light.



36in - Pushlock Male 2Pin M19 -
Pushlock Female 2Pin M19

FLUCDCG7072010

Min Buy 1 EA



72in - Pushlock Male 2Pin M19 -
Pushlock Female 2Pin M19

FLUCDCG7072110

Min Buy 1 EA

Fluence Dimmer

The Fluence Dimmer is a reliable, user-friendly dimmer that controls the light intensity from 0-100% of Fluence light fixtures. This device allows growers to control the light intensity of their Fluence light fixtures via an easy-to-use up/down arrow function, and clearly shows the user their light output intensity percentage via a digital display. This dimmer is meant to control the overall light intensity and maintain a set point of your Fluence LED light fixtures. It is not a relay or digital schedule timer to control photoperiod.



3.92in L x 3.43in W x 1.35in H
FLUCWU

Min Buy 1 EA



Fluence Dimming Mounting Bracket

Mounting bracket used for dimmer.



Set of 2 Brackets
FLUAMPS1024410

Min Buy 1 EA



Fluence Dimming Signal Cable

Dimming signal cable used for dimmer.



10in
FLUCDMA7097210

Min Buy 1 EA

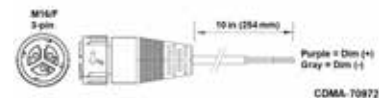

Fluence Dimming Signal Wire Connector

2-position terminal connectors are included to connect the dimming signal wires.



2-Position Connector
FLUADMA7098310

Min Buy 1 EA





HID

Megaphoton 3K Lamp

3000K color temperature, single-ended ceramic metal halide lamp small size, high luminous efficiency, broad spectrum, during the life of the light color stability. Typical Par Output (PPF): 570 μ mol/s. High light efficiency, good light color. High luminous flux maintenance rate. Long life lasting. Terrific safety performance. Color rendering index Ra>65.



315W

MEG315W3KLAMP

UPC 697416326800

Min Buy 1 EA



Megaphoton 4K Lamp

4200K color temperature, single-ended ceramic metal halide lamp small size, high luminous efficiency, broad spectrum, during the life of the light color stability. Typical Par Output (PPF): 570 μ mol/s. High light efficiency, good light color. High luminous flux maintenance rate. Long life lasting. Terrific safety performance. Color rendering index Ra>65.



315W

MEG315W4KLAMP

UPC 697416326801

Min Buy 1 EA



Megaphoton DE PRO Lamp DE Lamp 240V

Double ended Pro lamp. Par Output (PPF): 2100 μ mol/s. Lumen output maintenance rate 95% after 10000 hours.



1000W - 240V

MEG1000WDELAMP

UPC 697416326802

Min Buy 1 EA



Megaphoton Double Ended High Pressure Sodium Grow Light Fixture HID

The 750W double ended lamp is the most efficient HPS lamp on the market. The Megaphoton housing keeps the electronics cool, significantly reducing the possibility of faults and extending its operating life. In independent tests, the fixture came out as the coolest. To distribute the light, we offer the choice of three different reflectors, all of which deliver unprecedented uniformity of light. Dimmable, with controller port.



750W - 120-240V

MEGH1750WCY1WGI18

UPC 069741632610

Min Buy 1 EA



Megaphoton Double Ended High Pressure Sodium Grow Light Fixture HID Lamp White

The 1000W double ended lamp is the most efficient HPS lamp on the market. The Megaphoton housing keeps the electronics cool, significantly reducing the possibility of faults and extending its operating life. In independent tests, the fixture came out as the coolest. To distribute the light, we offer the choice of three different reflectors, all of which deliver unprecedented uniformity of light. Dimmable, with controller port.



1000W - 240V

MEGH11000240K5WGIA

Min Buy 1 EA



Megaphoton Double Ended High Pressure Sodium Grow Light Fixture HID White Closed Reflector

The 1000W double ended lamp is the most efficient HPS lamp on the market. The Megaphoton housing keeps the electronics cool, significantly reducing the possibility of faults and extending its operating life. In independent tests, the fixture came out as the coolest. To distribute the light, we offer the choice of three different reflectors, all of which deliver unprecedented uniformity of light. Dimmable, with controller port.



1000W - 277V

MEGH11000277DWSNA

Min Buy 1 EA



Megaphoton Double Ended High Pressure Sodium Grow Light Fixture HID White Closed Reflector w/Dimmer

The 1000W double ended lamp is the most efficient HPS lamp on the market. The Megaphoton housing keeps the electronics cool, significantly reducing the possibility of faults and extending its operating life. In independent tests, the fixture came out as the coolest. To distribute the light, we offer the choice of three different reflectors, all of which deliver unprecedented uniformity of light. Dimmable, with controller port.



1000W - 120-240V

MEGH11000CY1WGI19

Min Buy 1 EA



Megaphoton Double Ended High Pressure Sodium Grow Light Fixture HID White Open Reflector w/Dimmer

The 1000W double ended lamp is the most efficient HPS lamp on the market. The Megaphoton housing keeps the electronics cool, significantly reducing the possibility of faults and extending its operating life. In independent tests, the fixture came out as the coolest. To distribute the light, we offer the choice of three different reflectors, all of which deliver unprecedented uniformity of light. Dimmable, with controller port.



1000W - 120-240V

MEGH11000CY1WGI18

Min Buy 1 EA



MEGAPHOTON

HID

Megaphoton Dual Ceramic Metal Halide Grow Light Fixture Closed Reflector

The Dual CMH 630w system features a dual ceramic bulb configuration for 2x the growing power of standard 315w CMH. The 315W CMH Single lamp is the most efficient CMH lamp on the market. The Megaphoton housing keeps the electronics cool, significantly reducing the possibility of faults and extending its operating life. In independent tests, the fixture came out as the coolest. With Closed Reflector.



630W - 120-240V
MEGH2315CSWWNK
 Min Buy 1 EA



Megaphoton Hydro HPS

The 1000W double ended HPS lamp is the most efficient HPS lamp on the market. The Megaphoton housing keeps the electronics cool, significantly reducing the possibility of faults and extending its operating life. In independent tests, the fixture came out as the coolest. To distribute the light, we offer the choice of three different reflectors, all of which deliver unprecedented uniformity of light.



1000W
MEGH11000EY1WGIJ
 UPC 069741632610
 Min Buy 1 EA



1000W - 100-240V
MEGH11000CG2WGIC
 Min Buy 1 EA

1000W - 120-240V
MEGH11000CY1WGI27
 Min Buy 1 EA

Megaphoton Single Ended Ceramic Metal Halide Grow Light Fixture White

The 315W CMH Single lamp is the most efficient CMH lamp on the market. The Megaphoton housing keeps the electronics cool, significantly reducing the possibility of faults and extending its operating life. In independent tests, the fixture came out as the coolest. To distribute the light, we offer the choice of three different reflectors, all of which deliver unprecedented uniformity of light.



315W - 120-240V
MEGH1315CKWWVE
 UPC 069741632610
 Min Buy 1 EA



LED

Megaphoton LED for Grow Tents

High quality LED grow light, suitable for grow tents/indoor growing. With Samsung & Osram chips, Inventronics driver, longer lifetime and better performance.



100W - 100-277V
MEGMLTRT10000
 Min Buy 1 EA



Megaphoton LED for Grow Tents

High quality LED grow light, suitable for grow tents/indoor growing. With Samsung & Osram chips, Inventronics driver, longer lifetime and better performance.



200W - 100-277V
MEGMLTRT20000
 Min Buy 1 EA



Megaphoton LED for Grow Tents

High quality LED grow light, suitable for grow tents/indoor growing. With Samsung & Osram chips, Inventronics driver, longer lifetime and better performance.



450W - 100-277V
MEGMLTRT45000
 Min Buy 1 EA



Megaphoton LED White ML-TCS24003 Lamp

LED toplighting can shorten growth cycles, increase yields, reduce energy and enable more economic use of space. Improve shelf-life, color, shape and taste. High light output, while radiating much less heat than HPS toplighting, ensuring more control over your climate. Year-round production (also in low greenhouses).



600W
MEG600WLED
 UPC 069741632650
 Min Buy 2 EA



Megaphoton LED White ML-TCL12001 Lamp

LED toplighting can shorten growth cycles, increase yields, reduce energy and enable more economic use of space. Improve shelf-life, color, shape and taste. High light output, while radiating much less heat than HPS toplighting, ensuring more control over your climate. Year-round production (also in low greenhouses).



300W
MEG300WLED
 UPC 069741632650
 Min Buy 2 EA



MEGAPHOTON

LED

Megaphoton 6 Bar LED Light Kit

Megaphoton 630W LED 6 bar grow light fixture and light driver.



630W

MEG6BARKIT

Min Buy 1 EA



Megaphoton 8 Bar LED Light Kit

Megaphoton 630W LED 8 bar grow light fixture and light driver.



630W

MEG8BARKIT

Min Buy 1 EA



LED

HLG 65 V2

HLG 65 V2 Lamp is designed for vegging, clones, supplemental lighting or a small plant. This lamp uses our custom designed high efficiency white light Quantum Boards®. With a total of 120 Samsung LM301H LED's, this fixture produces 10,000 Lumens with just 65 Watts of power. Equivalent to 150W T5 or 200W CFL output or 150W metal halide.



65W - 10,000 Lumens

HLG65V2

UPC 850019573053

Min Buy 1 EA

65W - 10,000 Lumens

HLG65V2Q4

UPC 850019573053

Min Buy 4 EA

65W - 10,000 Lumens

HLG65V2Q16

UPC 850019573053

Min Buy 16 EA



HLG 100 Rspec®

HLG 100 Rspec® uses a high efficiency white light Quantum Boards® made by Samsung using the latest LM301H full spectrum LED and LM351H Deep Red LED to help with flowering. This fixture produces 220 PPF, 14,000+ Lumens with just 95 Watts of power. Equivalent to 220W T5 or 300W CFL output or 200W metal halide.



95W - 14,000+ Lumens

HLG100RSPEC

UPC 850019573169

Min Buy 1 EA

95W - 14,000+ Lumens

HLG100RSPECQ4

UPC 850019573169

Min Buy 4 EA

95W - 14,000+ Lumens

HLG100RSPECQ16

UPC 850019573169

Min Buy 16 EA



HLG 100 V2

HLG 100 V2 uses our custom designed high efficiency white light Quantum Boards®. With a total of 192 Samsung LM301H LED's, this fixture produces 16,000+ Lumens with just 95 Watts of power. Equivalent to 220W T5 or 300W CFL output or 200W metal halide.



95W - 16,000+ Lumens

HLG100V24K

UPC 806810036061

Min Buy 1 EA

95W - 16,000+ Lumens

HLG100V24KQ4

UPC 806810036061

Min Buy 4 EA

95W - 16,000+ Lumens

HLG100V24KQ16

UPC 806810036061

Min Buy 16 EA





LED

HLG 350R

HLG 350R Commercial Indoor Horticulture LED grow light is designed to replace a 600 watt HID with just 330 Watts. Each HLG 350R uses 2 of our custom designed full spectrum high efficiency Advanced Diablo™ Quantum Boards® with Samsung Full Spectrum White & Deep Red. With a rectangular footprint this fixture is ideal for flowering in smaller grow spaces or vegging in a commercial grow. This incredibly efficient full spectrum horticulture lamp has an efficiency of 3.11 PPF/W. This lamp has a new improved spectrum with a broad blue wavelengths.



330W

HLG350R

UPC 850019573190

Min Buy 1 EA

330W

HLG350RQ6

UPC 850019573190

Min Buy 6 EA

**HLG 650R**

HLG 650R Commercial Indoor Horticulture LED grow light is designed to replace a double-ended 1000 watt HID lamp and consumes only 650 watts. 650R uses 4 of our custom designed full spectrum high efficiency white light Quantum Boards® with Samsung LM301H and Deep Red LED 660nm . This unit is controller compatible and dimmable, with wattage output from 60 to 630 watts. Controller compatibility via RJ 12 available upon request.



650W

HLG650R

UPC 850019573008

Min Buy 1 EA

650W

HLG650RQ8

UPC 850019573008

Min Buy 8 EA

**HLG 600 Bspec®**

Our HLG 600 Bspec® Commercial Indoor Horticulture LED grow light is designed to replace 1000 watt HID. Each HLG 600 Bspec® uses 4 of our custom designed full-spectrum high efficiency white light Quantum Boards® with Samsung LM301H and Blue 470nm . This unit is dimmable, with wattage output from 60 to 600 watts. Controller compatibility via RJ 12 available upon request.



60W-600W

HLG600BSPEC

UPC 850019573152

Min Buy 1 EA

60W-600W

HLG600BSPECQ8

UPC 850019573152

Min Buy 8 EA

**HLG Scorpion Diablo™**

HLG Scorpion Diablo™ is designed for grows with low ceiling heights or for vertical racks. HLG Scorpion Diablo™ uses 6 Advanced Design Diablo™ Quantum Boards® for an even light spread at just 15" from the canopy. This incredibly efficient full spectrum horticulture lamp has an efficiency of 3.2 PPF/W. This lamp has a new improved spectrum with a broader blue. Controller compatibility via RJ 12 available upon request.



6 Boards

HLGSCORPIONDIABLO

UPC 850019573176

Min Buy 1 EA

6 Boards

HLGSCORPIONDIABLOQ8

UPC 850019573176

Min Buy 8 EA

**HLG 600 Rspec®**

Our HLG 600 Rspec® Commercial Indoor Horticulture LED grow light is designed to replace a 1000 watt HID. Each HLG 600 Rspec® uses 4 of our custom designed full spectrum high efficiency white light Quantum Boards® with Samsung LM301H and Deep Red 660nm LED's. This unit is dimmable, with wattage output from 60 to 600 watts. Controller compatibility via RJ 12 available upon request.



60W-600W

HLG600RSPEC

UPC 850019573145

Min Buy 1 EA

60W-600W

HLG600RSPECQ8

UPC 850019573145

Min Buy 8 EA

**HLG Scorpion Rspec®**

HLG Scorpion Rspec® is designed for grows with low ceiling heights or for vertical racks. HLG Scorpion Rspec® uses 6 QB288 Quantum Boards® for an even light spread at just 12" from the canopy. Our QB288 uses Samsung's latest LM301H and Deep Red LED 660nm. This unit is dimmable, with wattage output from 60 to 600 watts. Controller compatibility via RJ 12 available upon request.



6 Boards

HLGSCORPIONRSPEC

UPC 850019573183

Min Buy 1 EA

6 Boards

HLGSCORPIONRSPECQ8

UPC 850019573183

Min Buy 8 EA





HID

EYE HORTILUX® 1000W DE Ceramic HPS Lamp

Ceramic HPS is not your standard HPS light. A typical HPS light produces an orange light with a narrow spectral distribution. The Ceramic HPS produces a white light and has a much broader spectrum with an abundance of red spectral energy. It enhances essential oil production and produces plants with minimal stretching. It also produces vibrant colorful plants which stay strong and healthy throughout the flowering stage. Use the DE Ceramic HPS on its own in your flower room or in a checkerboard setup with our standard DE HPS grow lamp.



CLU1000DE - HTL - EN

EYE62111

UPC 639125621113

Min Buy 6 EA

**EYE HORTILUX® 1000W DE Super HPS Grow Lamp**

Get higher yields and a higher performance with the new DE Super HPS grow lamp from EYE HORTILUX®! This reliable light source was built with quality construction and is made in the USA. Its exclusive EYE HORTILUX spectrum provides a photosynthetic photon flux (PPF) of 2120 $\mu\text{mol}/\text{sec}$ at 1000W and 2400 $\mu\text{mol}/\text{sec}$ at 1150W for consistently high yields through multiple grow cycles. The DE Super HPS must be powered by electronic ballasts that operate at or above 100 kHz. For best performance, operate on EYE HORTILUX ballasts such as the DE 1000-VS grow light system.



LU1000DE - HP - HTL

EYE62201

UPC 639125622011

Min Buy 6 EA



LU1000DE - HP - HTL - BULK

EYE100770

Min Buy 24 EA

EYE HORTILUX® BLUE Metal Halide Grow Lamp

The EYE HORTILUX® Daylight Blue Metal Halide is by far the world's most powerful grow light. This grow lamp produces plants with extremely tight internodal spacing for nice compact, bushy plants. This allows the plant to produce large colorful fruits and flowers. When using the BLUE during the vegetative stage, it can shorten this period by one full week – allowing for one extra crop per year. It is the closest match to natural sunlight of any light source available today. This lamp is for experienced growers who demand the highest quality plant production during ALL phases of plant growth. Made in the USA.



BLUE MH - 1000 Watt - 4 Minute Warm Up Time - 15 Minutes Hot Re-Strike Time - Horizontal +/- 15 degrees Operating Position - E-Ballast Compatible - 80000 Initial Lumen - 5500K - 92 CRI

EYE57945

UPC 639125579452

Min Buy 6 EA

**EYE HORTILUX® Ceramic Metal Halide Grow Light System with Lamp**

Lower energy costs and reduce space needed with the CMH 315 Grow Light System. Components are optimized to work together efficiently. The shape and metal composition of the reflector were designed to work together with the ballast and lamp to give you a more even distribution of light over the target area. This optimization provides 30% more uniform light to plant canopy and 8% more light overall than the competition.



CMH315 System

EYE90001

UPC 639125900010

Min Buy 1 EA

**EYE HORTILUX® Ceramic Metal Halide Lamp**

Ceramic Metal Halide (CMH) designed specifically for horticulture. Most ceramic metal halide lamps were designed for use in the retail space, so the UV light was blocked. Hortilux uses a glass that allows the UV light to pass through benefiting plant growth. The exclusive EYE HORTILUX® CMH spectrum provides 50% more Ultra Violet (UV) than the competitive lamps available today. This results in better overall plant growth and higher yields. Made in the USA.



CMH315

EYE55216

UPC 639125552165

Min Buy 12 EA

**EYE HORTILUX® Super High Pressure Sodium Grow Lamps**

EYE HORTILUX® HPS grow lamps have been producing quality plants and large yields for decades. Produces noticeably bigger, fuller flowers and overall heavier yields. Maintains results after multiple growth cycles, saving you money. Provides 25% more light energy than competitive brands in Violet, Blue and Green. Provides 17% more total spectral energy than the competition. Produces more spectral balance for increased plant response and accelerated growth. Made in the USA.



600 Watt - Universal Operating Position - E-Ballast Compatible - 5 Minutes Warm-Up Time - 2.5 Minutes Hot Re-Strike Time - 88000 Initial Lumen - 2100K Color Temperature - 25 CRI

EYE66710

UPC 639125667104

Min Buy 12 EA



1000 Watt - Universal Operating Position - E-Ballast Compatible - 5 Minutes Warm-Up Time - 15 Minutes Hot Re-Strike Time - 145000 Initial Lumen - 2100K Color Temperature - 26 CRI

EYE66785

UPC 639125667852

Min Buy 6 EA



Double Ended - 1000 Watt - Universal Operating Position - E-Ballast Compatible - 5 Minute Warm-Up Time - 15 Minutes Hot Re-Strike Time - 155000 Initial Lumen - 1950K Color Temperature - 25 CRI

EYE62100

UPC 639125667857

Min Buy 6 EA



Double Ended - 1000 Watt - BULK

EYE100339

Min Buy 24 EA

GE current

a Daintree company

SUNBLASTER

HORTICULTURAL LIGHTING

LED

GE Arize Element L1000 Next-Gen

The Arize Element L1000 Next-Gen is the most advanced, flexible greenhouse grow light on the market. With efficacy levels surpassing 3.6 $\mu\text{mol}/\text{J}$, industry leading 5-year warranty and three application specific models the Next-Gen Element is your new go-to solution for commercial greenhouse growers of all sizes. The next generation of the Arize Element L1000 can scale as your business grows, offering industrial-strength reliability, and class-leading efficiency. Engineered to provide 1:1 replacement of legacy HPS grow lights, cultivators can produce top quality harvests in all seasons while enjoying massive energy cost reductions compared with legacy grow lights. Made in the USA.



600watt 120-277volt 2/bx
HA30171
 Min Buy 1 EA



GE Arize Greenhouse Pro

Arize Greenhouse Pro Photoperiodic LED Lamp - The GE Arize™ Greenhouse Pro LED lamp is designed to facilitate greenhouse photoperiod control. Photoperiod control allows growers to manage vegetative growth or rapid flowering throughout the year by extending or shortening day-length. This lamp will help control plant growth so the production is ready at the precise time. When selecting the best equipment for your greenhouse, choose GE Arize™ Greenhouse Pro LED flowering lamp to control and create ideal growth conditions. Low energy and high results are the focus of Arize Greenhouse Pro LED Lamp and is sure to provide optimal plant management.



Flowering Lamp
HA93042116
 Min Buy 1 EA



Propagation

SunBlaster™ LED Micro Growlight Garden

Same features as the Growlight Garden but in a reduced footprint making it ideal for those with limited space. Grow what you love, love what you grow - all year long. Perfect for growing salads and herbs or for early season seed starting. Use also to boost flowering house plants out of season. Plants are never over-watered or under-watered, keeping them healthy and promoting vigorous root growth. An inner platform keeps plants above the water level, and a convenient fill hole lets you top up the reservoir as needed. Supplied with 4 reusable tough growing trays for easy succession planting. Includes raised platform insert and capillary matting allowing plants to self water for up to 7 days. Micro LED Growlight Garden includes: SunBlaster 12in 6400K LED Strip Light, Power-cord with on/off switch, raised platform with wicking mat (for auto watering), and four heavy duty reusable seedling trays.



Black - Dimensions: 21in Wide x
 5.25in Deep x 8.5in Tall
SBL1600218
 UPC 628836162183
 Min Buy 6 EA



SunBlaster™ CFL Lamp

A full spectrum daylight CFL that will have your plants basking in sunlight all day and night. This lamp emulates the sun with little heat so you don't have to worry about harming any of your plants.



26 Watt - 10,000 Hours - 1700 Lumen - 6400
 Kelvin - Single Pack
SBL0900156
 UPC 628836091568
 Min Buy 12 EA



SunBlaster™ LED Strips

Designed to maximize overall performance, economy and extend longevity, while providing the best possible lighting for all Indoor Horticultural applications without fail or compromise. Utilizing SunBlaster Lighting's patented Self-Cooling Technology (SCT) to create the most advanced Horticultural lighting available today. Self-Cooling Technology allowed SunBlaster Lighting engineers to push the lighting output to the desired levels without creating unwanted heat, or wasting valuable electronic resources running cooling fans or other unwanted devices. 6400K Color Temp - 120° Lighting Angle Rated Life for 50,000 Hours. Also available in 12in, 18in, 36in and 48in



24in LED Strip - 2,550 Lumen - 24 Watts - 48 LED
SBL0900702
 UPC 628836097027
 Min Buy 6 EA



SUNBLASTER

HORTICULTURAL LIGHTING

Propagation

SunBlaster™ T5HO Complete Lamp & Fixture Kit with NanoTech Reflector

Fixtures link together, regardless of length, to a maximum of eight units up to 36in fixtures and 6 units up to 48in fixtures. Used as supplemental overhead and side lighting, as well as additional light for tall plants when hung vertically, their slim design allows them to fit virtually anywhere you need additional light. Cost effective to operate, easy to install and uses minimal watts per lamp with a long lamp life of over 10,000 hours. Complete kit includes: electronic ballast, NanoTech reflector, 6400K lamp, power cord, jumper plug and mounting clips. Also available in 12in and 18in.



24in - 24 Watt - 6400K

SBL0900302

UPC 628836093029

Min Buy 1 EA

36in - 39 Watt - 6400K

SBL0900303

UPC 628836093036

Min Buy 6 EA

48in - 54 Watt - 6400K

SBL0900304

UPC 628836093043

Min Buy 6 EA



SunBlaster™ T5HO Lighting Kit

Lighting that allows you to extend the growing season by providing your plants with an indoor equivalent to mother nature's sunlight. This is a great advantage for those who appreciate having a year-round supply of fresh flowers, vegetables, and herbs. Also available in 36in.



24in, 24W, 110-130V

SBL0900172

UPC 628836091728

Min Buy 6 EA

48in, 54W, 110-130V

SBL0900174

UPC 628836091742

Min Buy 1 EA



SunBlaster™ T5HO Replacement Lamp

Produces a high quality light resulting in large lit area and a superior light penetration. This lamp simulates natural sunlight and is ideal for cuttings and vegetative growth.



18in - 6400K

SBL0900354

UPC 628836093548

Min Buy 6 EA



SunBlaster™ T5HO Replacement Lamp

Produces a high quality light resulting in large lit area and a superior light penetration. This lamp simulates natural sunlight and is ideal for cuttings and vegetative growth. Also available in 12in, 18in, 24in and 36in.



48in - 6400K

SBL0900177

UPC 628836091773

Min Buy 6 EA



SunBlaster™ Universal Strip Light Stand

The Universal Strip Light Stand allows you to set the exact lighting height up to 18" to get your seedlings or fresh cuttings off to their best starts ever. Simple adjustment makes setting the correct height quick and easy. Light fixture not included.



18in H

SBL0900095

UPC 628836090950

Min Buy 6 EA





LED

TotalGrow™ High Intensity Top Light Power Cord

The TotalGrow Multi-HI features multiple high intensity light bars in a thin form factor to evenly distribute the ideal intensities of light over your grow area to match your growing goals. An exceptional, customizable, full light spectrum supports efficient, quality growth for any life stage and crop variety. This plug-and-play solution with built-in daisy-chaining is simple to implement with low upfront and ongoing costs for the sustainable production of high quality crops. Standard versions include 170-640W lights for light intensities of approx. 500-1000 PPFD in 2ft x 4ft – 4ft x 4ft areas. (Initial power cord sold separately)



60in Power Cord with NEMA 5-15P Plug
CP-N5-M19-60
 Min Buy 1 EA



TotalGrow™ Pure Flowering 200 Lamp

The most efficient and effective solution for simulating long days to control the timing of flowering. Perfect balance of red and far-red light output for night interruption/day length extension. No wasted light output in non-photoperiodic regions. Minimal power consumption and electrical infrastructure needs with simple installations.



17W - 100-240V - Life hrs: 50,000 -
 typical Coverage: 200sq ft
TG1B-3A-1104-BA4
 Min Buy 1 EA



TotalGrow™ Pure Flowering Lamp Socketed Cord

Socket cord for the Installation of TotalGrow™ Pure Flowering 200 Lamps. Socket Base Size: E26. Voltage: 100-240V. Approximate Max Power: 600W. Cable Gauge: AWG16. Plug: Polarized NEMA 1-15P



330ft - 15ft socket spacing - 22 sockets
CS-180-330
 Min Buy 1 EA

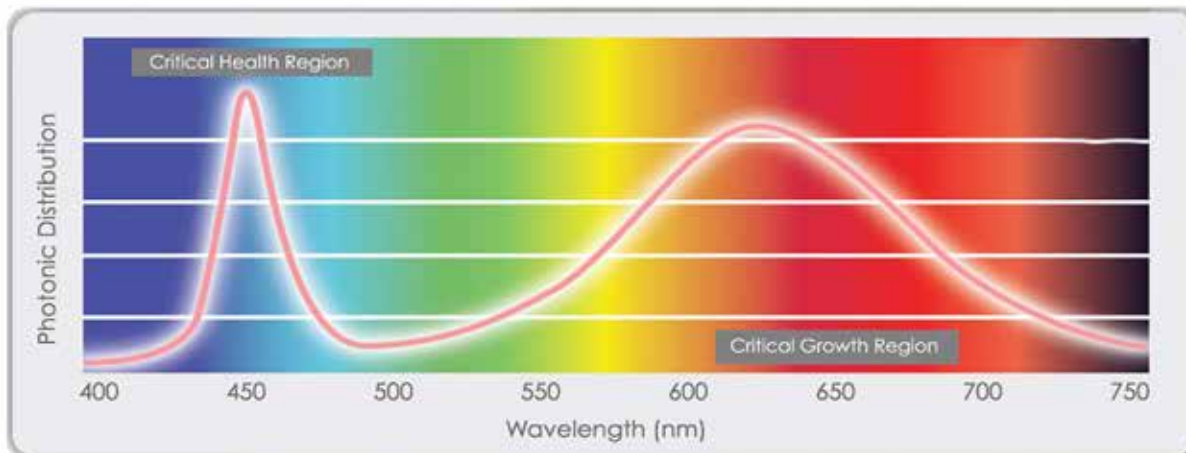

Blue Photons (400-499nm)	Green-Yellow Photons (500-599nm)	Orange-Red Photons (600-700nm)	Far-Red Photons (701-800nm)
<ul style="list-style-type: none"> • Drive dense plant growth • Support plant health and appearance • Support root development and nutrient production • Stimulate chlorophyll production and gas exchange 	<ul style="list-style-type: none"> • Provide the least amount of growth per photon • Provide the best penetration for subcanopy growth • Enable visual health assessment 	<ul style="list-style-type: none"> • Most efficient at driving plant growth • Best chlorophyll absorption • Critical for flowering and day length control 	<ul style="list-style-type: none"> • Support total plant function • Enhance the photosynthetic efficiency of other wavelengths • Enable day length control

Broad Spectrum: TotalGrow™ provides a broad spectrum of light in the wavelengths that plants need most for quick and healthy growth.

Growing perfect plants has never been easier.

PRISMATIC LED STRIPS

Our new Prismatic LED Strips provide a 90° lens to harness faster growth by focusing light where the plant canopy develops, without creating excess heat and wasted energy.

PERFECT PROPAGATION

We take the guess work out of propagation so you can get growing!



SUNBLASTER
HORTICULTURAL LIGHTING

SUNBLASTERLIGHTING.COM
RESIDENTIAL | COMMERCIAL | OEM APPLICATIONS

Did you know...?

BFG has a mobile app to make ordering easier!

Available for download on the app store and Google play

Containers

Fertilizers

Growing
Media

Benching



GrowerSelect[®]

Carts
Structures

And More!



Call today for your customized quote!

The background of the image is a close-up photograph of vibrant green leaves, likely from a plant like basil, showing detailed vein patterns and slightly serrated edges. Overlaid on this is a large white diamond shape, which is framed by a thick, dark teal border. The word "IRRIGATION" is centered within the white diamond in a clean, black, sans-serif font.

IRRIGATION

Complete Irrigation *System Design*

DRAMM

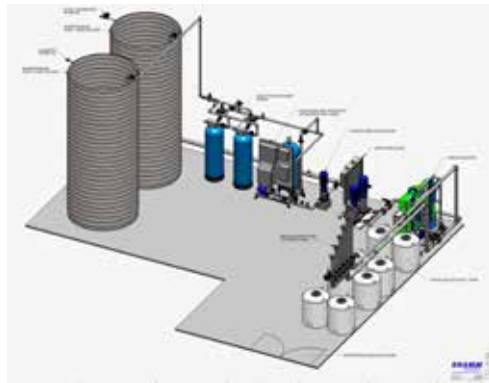
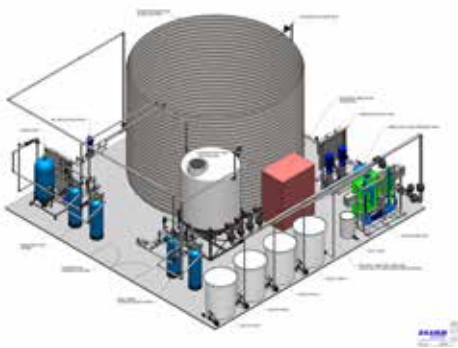

**Irrigation systems are more than just nozzles or drippers.
*A complete system requires fittings, filters, valves and controls.***

BFG & Dramm can design and ship your next irrigation system complete, including all of the necessary connections, filters and controls. Having us design your system costs nothing and saves time and trips to the plumbing supply.

Make sure your system works as it should, is protected against clogs and is ready for maintenance. BFG Dramm has the expertise needed to make your system work properly.

BFG Dramm can provide a complete quote for your system and will include an itemized parts list and a basic schematic. More complex systems may require additional drawings.

DRAMM

Components & Tips



DRAMM® PCR Dribble Ring with Leader Tube

Dramm PCR Pressure Compensated Dribble Rings offer accuracy with even watering, spreading the water around larger containers. Unlike the weighted or stake ended drippers, the Dribble Rings use a removable ring to distribute the water throughout the pot. The ring separates at the T to allow for easy installation and removal. The PC Rings utilize the larger body design PCAS emitters for accuracy and a reduction in clogging. These emitters each have a controlled output that will remain constant from 15 - 50 psi. PC Rings are great for nursery stock, B&B stock, and larger containers.



6in Ring - 24in Tube

DRMPCR68L246

Min Buy 1 EA

6in Ring - 36in Tube

DRMPCR68L366

Min Buy 1 EA



8.5in Ring - 24in Tube

DRMPCR858L2485

Min Buy 1 EA

8.5in Ring - 36in Tube

DRMPCR858L3685

Min Buy 1 EA



10in Ring - 24in Tube

DRMPCR108L2410

Min Buy 1 EA

10in Ring - 36in Tube

DRMPCR108L3610

Min Buy 1 EA



13in Ring - 24in Tube

DRMPCR138L2413

Min Buy 1 EA

13in Ring - 36in Tube

DRMPCR138L3613

Min Buy 1 EA

Components & Tips

Dramm® Anchor Stake for Dribble Ring

Holds ring in place in pot. Use one per ring.



DRMS3ANCHOR

Min Buy 1 EA



Dramm® Dribble Tube Drip Irrigation

The simple way to water plants automatically by dripping water into each pot directly. The flow rate is controlled by the diameter and length of the tube.



DTL - 24in - .075in ID - .125in OD - Blue

DRMDTL24

Min Buy 1 EA

DTM - 18in - .060in ID - .100in ID - Green

DRMDTM18

UPC 049961977938

Min Buy 1 EA



Watering Tools & Supplies



DRAMM® Watering Can

Assorted colors include red, orange, yellow, green, blue, purple. Superior design and balance. Features a plastic rose for a gentle shower. High-grade, injection molded plastic. Made in the U.S.A.



5L (1.33gal) Capacity - Assorted Colors

DRM6012450

Min Buy 6 EA

DRAMM

Watering Tools & Supplies

DRAMM® ColorMark™ Rain Wand

Save time and water while thoroughly watering plants, flowers and shrubbery. This superbly balanced wand provides a gentle, full-flow shower that won't wash away soil or harm tender plants. The 30in ColorMark™ Rain Wand has a foam grip for comfortable watering. The brass shut-off valve is handcrafted and durable; able to withstand a lifetime of use, and has been used by professional growers for over 75 years.



30in L - Uncarded - Assorted Colors:
Red, Orange, Yellow, Green, Blue &
Berry

DRM1010000

Min Buy 12 EA



DRAMM® Colormark™ Rain Wand

Efficiently saves water while watering plants, flowers, and shrubbery. The wand is equipped with a one-touch lever activated valve. Simply squeeze the lever to water and release the lever to stop watering while moving from one plant to the next. Gentle, full flow for quick watering. Comfort foam grip. Hand crafted brass shut-off valve



30in L - Carded

DRM1020000

Min Buy 12 EA



DRAMM® One Touch™ Rain Wand

Water with ease with the One Touch Rain Wand. Allows complete and total water flow control with just one touch of your thumb. Thus eliminating the strain from squeezing as in many current watering tools. Efficiently saves water while watering from one plant to the next. Made with aluminium for a lightweight and durable feel and has rubber over mold for additional protection at the natural wear-point.



30in L - Uncarded - Assorted Colors:
Red, Orange, Yellow, Green, Blue &
Berry

DRM1014800

Min Buy 12 EA



DRAMM® Telescoping RainSelect Rain Wand™

Easily extends from 34" to 55", and anywhere in between. Large, tough and durable telescoping mechanism easily adjusts, even with wet slippery hands. Additional foam grip provided to balance the wand at any length.



34in to 55in

DRM1013620

Min Buy 6 EA



DRAMM® RainSelect™ Rain Wand

Select one of nine water patterns with the simple turn of a dial. The Dramm One Touch thumb valve provides complete water flow control. Comes with a consumer lifetime guarantee.



30in L - Assorted Colors: Red, Orange,
Yellow, Green, Blue, & Berry

DRM1013600

Min Buy 12 EA



DRAMM® Touch'N Flow™ Rain Wand™

The Touch'N Flow Rain Wand efficiently saves water while watering plants, flowers and shrubbery. The Touch'N Flow Rain Wand is equipped with a lever activated valve. Simply squeeze the lever to water and release the lever to stop watering while moving from one plant to the next. A must-have in water restricted areas. Plus, with the bright color options it will no longer be lost in your lawn.



30in L - Uncarded - Assorted Colors: Red,
Orange, Yellow, Green, Blue & Berry

DRM1012812

UPC 036434128126

Min Buy 12 EA



DRAMM® One Touch™ Rain Wand

Water with ease with the One Touch Rain Wand. Allows complete and total water flow control with just one touch of your thumb. Thus eliminating the strain from squeezing as in many current watering tools. Efficiently saves water while watering from one plant to the next. Made with aluminium for a lightweight and durable feel and has rubber over mold for additional protection at the natural wear-point.



16in L - Uncarded - Assorted Colors: Red,
Green, Blue & Berry

DRM1014860

Min Buy 12 EA



DRAMM® Handi-Reach™ Water Wand with Touch N Flow Handle

Designed to eliminate the stretching and stooping associated with hand watering. Made in the U.S.A. from extruded aluminum tubing, forged brass hose couplings and a comfort EPDM hand grip. .75 male and female hose threads.



24in - .75 Threads

DRM1073481

Min Buy 1 EA

48in - .75 Threads

DRM13485

Min Buy 1 EA



DRAMM

Watering Tools & Supplies

Dramm® Handi-Reach™ Handle

Designed to eliminate the stretching and stooping associated with hand watering. Made in the U.S.A. from extruded aluminium tubing, forged brass hose couplings and a comfort EPDM hand grip. .75 male and female hose threads.



16in - .75 Threads

DRM116GC

UPC 036434223548

Min Buy 1 EA

24in - .75 Threads

DRM124GC

Min Buy 1 EA



30in - .75 Threads

DRM130GC

Min Buy 1 EA

48in - .75 Threads

DRM148GC

UPC 036434223579

Min Buy 1 EA

36in - .75 Threads

DRM136GC

Min Buy 1 EA

72in - .75 Threads

DRM172G

Min Buy 1 EA

Dramm® Handi-Reach™ Handle

Designed to eliminate the stretching and stooping associated with hand watering. Made in the U.S.A. from extruded aluminum tubing, forged brass hose couplings and a comfort EPDM hand grip. .75 male and female hose threads.



6in - .75 Threads

DRM106GC

Min Buy 1 EA



Dramm® Touch'N Flow PRO™ with Trigger

Full flow valve specialty designed for durability and ease of use. Features a one-touch lever activated valve and an ergonomic insulated grip. Offers up to 11gpm at 40psi. Made in the USA.



11gpm

DRM1073065

Min Buy 1 EA



Dramm® Stainless Steel Nozzle

Nozzle for AutoFog for use with corrosive chemicals to prevent damage to nozzle.



for SLVH and MLVH

DRM129J753A2

Min Buy 1 EA



Dramm® Fog-It Nozzle

Designed for misting delicate seedlings or for raising humidity around wilting plants. This nozzle has three mist jets which create a conical spray pattern. Available in four different discharge rates. Made in the U.S.A. from solid brass. .75 hose threads.



.5gpm - Super Fine

DRM2072505

Min Buy 1 EA

1gpm - Fine

DRM2072506

Min Buy 1 EA

2gpm

DRM2072507

Min Buy 1 EA

4gpm

DRM2072508

Min Buy 1 EA



Dramm® Seedling Nozzle

The Seedling Nozzle allows you to water fragile plants, delicate seedlings or plant cuttings. This high-quality nozzle produces an extra fine, hollow cone mist pattern and sprays 1/2 gallon of water per minute. Made in the U.S.A. from solid brass.



.75in Thread

DRM2072350

Min Buy 1 EA



Dramm® 540 Brass Rose Nozzle

Brass Rose features an extra wide spray pattern, which allows you to increase the speed of hand watering. Great for watering bedding plants, pots or market packs. Includes protective rubber guard and metric to inch hose thread converter. Made in Germany.



.75in Hose Thread - 4in Diam

DRM1072540

Min Buy 1 EA



Dramm® 360 Degree Nifty Nozzle

Nifty Nozzles offer an economical solution for simple "overhead or on the bench" watering systems. These nifty nozzles produce a 10ft dia. spray pattern when your water pipeline is 5ft above the crop. Nifty Nozzles can be installed on the topside of the pipeline, on bottom side of the pipeline or on top of 1/2 PVC risers. Bottom side installations require no-drip check valves to prevent drip.



Blue - 2.50mm

DRM360NNBL

Min Buy 1 EA



DRAMM

Watering Tools & Supplies

Dramm® Screen-Aire Water Breaker® 350PL Nozzle

Designed to water nursery containers with a gentle, concentrated aerated flow of water. A fine-mesh screen and an array of internal components combine air and water to produce a very soft, unrestricted spray. Use a Dramm In-Line Hose Filter to keep the nozzle from clogging. Made in the U.S.A.



.75in Brass Thread

DRM2072550

Min Buy 1 EA



Dramm® Water Breaker® Nozzle

Plastic water breaker designed to offer a low, soft flow that allows for more precise watering. The 750PL has 25% less hole surface area which offers a lower flow that can be regulated by a shut-off valve for minimal water and still retain a pattern.



Yellow - 7gpm - 40psi

DRM1071400

Min Buy 1 EA



Dramm® Water Breaker® Narrow Nozzle

This water breaker has over 1,000 micro holes that create an ultra-soft flower shower which will not disturb delicate soil or harm tender plants. Made in USA from ABS plastic and stainless steel.



Green - 7gpm - 40psi

DRM1071100

Min Buy 1 EA



Dramm® Water Breaker® Nozzle

The original full-flow shower head nozzle. Provides fast, full-flow watering without damage to your plants or disturbing soil. Cast aluminum and hand machined with 3/4 inch brass hose threads.



Aluminum - 11.1gpm - 40psi

DRM1072342

UPC 036434723420

Min Buy 1 EA



Dramm® Water Breaker® Nozzle

This plastic water breaker is designed for small containers (hanging baskets) and is an excellent choice for watering in areas with low water pressure.



Blue - 7gpm - 40psi

DRM1072349

Min Buy 1 EA



Dramm® Water Breaker® Nozzle

This water breaker has over 1,000 micro holes that create an ultra-soft flower shower which will not disturb delicate soil or harm tender plants. Made in USA from ABS plastic and stainless steel.



Red - 7gpm - 40psi

DRM1071000

Min Buy 1 EA



Dramm® Water Breaker® Wide Nozzle

This water breaker has over 1,000 micro holes that create an ultra-soft flower shower which will not disturb delicate soil or harm tender plants. Made in USA from ABS plastic and stainless steel.



Orange - 7gpm - 40psi

DRM1071200

Min Buy 1 EA



Dramm® Water Breaker® Nozzle

Provides fast, full-flow watering without damage to your plants. Patterned after the original 400 Aluminum water breaker, this product is made from high-impact ABS plastic and aluminum to provide a lightweight alternative.



Blue - 11.1gpm - 40psi

DRM1072346

UPC 049961970281

Min Buy 1 EA



Dramm® One Touch Valve

Fingertip water control. Zinc die cast body & nylon valve components for long life. Flow can be adjusted from off to full flow with thumb-tip precision. Flow rate 8gpm at 40 PSI.



8gpm

DRM1014700

UPC 036434147004

Min Buy 1 EA



Dramm® OneTouch™ HighFlow Valve

Fingertip water control. Zinc die cast body and nylon valve components for long life. Flow can be adjusted from off to full flow with thumb-tip precision. Larger opening for more flow. Offers up to 16gpm at 40psi.



16gpm

DRM1074800

Min Buy 1 EA



DRAMM

Watering Tools & Supplies

Dramm® QAV Shut Off Valve

The QAV uses a unique, patent-pending valve design includes a single-piece ball, stem and handle assembly to reduce the time to assemble while strengthening the structure. The QAV Valve replaces our 35 Shut-Off, keeping only its price-point. The QAV offers greater durability and a larger handle for easier watering.



Blue - 13gph
DRM1072318
 Min Buy 1 EA



Dramm® #74 Full Flow Shut Off Valve

Full flow valve specially designed for durability and ease of use. Features a one-touch lever activated valve and an ergonomic insulated grip. Offers up to 11gpm at 40psi. Made in the USA.



18gpm
DRM1073074
 UPC 036434227324
 Min Buy 1 EA



Dramm® Shut Off Valve

Aluminum shut off that offers unmatched durability and flow in a light weight package. Tested for corrosivity, our new valve holds up to high EC, low pH water with no trouble.



Aluminum - .75in Male-Female
DRM1073301
 UPC 036434223739
 Min Buy 1 EA



Dramm® Brass Hose Swivel

The Brass Hose Swivel is a live swivel that allows for unencumbered movement between the hose and attachments under pressure. Reduces hose twisting.



18gpm
DRM1072700
 Min Buy 1 EA



Dramm® Brass Shut-Off Valve

Simply the best shut-off valve available. Provides fingertip water control at the end of a greenhouse hose. A quarter turn of the large ergonomic handle and the water is off. Full water flow design. Made in the USA from brass, durable seals and a hard chrome plated ball to provide years of service. 3/4 threads.



17gpm
DRM1073300
 UPC 036434223531
 Min Buy 1 EA



Dramm® Quick Disconnect

Heavy-duty quick hose connection offers full-flow (pair) without water-stop. Made in the USA.



Brass
DRM740C
 Min Buy 1 EA



Dramm® Twisty Quick Hose Connect

Twisty Quick, a plastic quick connect hose adapter. Full water flow design. Design is made from heavy-duty plastic. 3/4 male and female hose threads. Sold as a pair



Black - .75in Thread
DRM710C
 Min Buy 1 PR



Dramm® Fitting / Ferrule Set

Fitting and Ferrule set for use with the DrammPress Hose Crimper and ColorStorm Hose. Comes with 12ea fitting and ferrule.



.625in Female
DRM1017815
 UPC 036434171856
 Min Buy 1 PK

.75in Female
DRM1017825
 Min Buy 1 PK

.625in Male
DRM1017810
 Min Buy 1 PK

.75in Male
DRM1017820
 Min Buy 1 PK



DRAMM® ColorStorm™ Premium Rubber Hose

Made with EPDM rubber, durable like car tires. Features crush-proof, nickel-plated couplings, hot water resistant up to 160 degrees F and designed to resist kinking. Coils easily even in cold weather. Made in the USA.



Assorted Colors: Red, Orange, Yellow,
 Green, Blue & Berry - 5/8in D x 50ft L
DRM1017000
 Min Buy 6 EA

Blue - .625in Diam x 50ft L
DRM1017005
 UPC 036434170057
 Min Buy 6 EA

Yellow - .625in D x 50ft L
DRM1017003
 UPC 036434170033
 Min Buy 1 EA



DRAMM

Watering Tools & Supplies

Dramm® ColorStorm™ Custom Hose Starter Kit

Make your own hose lengths easily and quickly with our Custom Hose Starter Kit. This kit makes it easier to get started cutting your own length of hose. The kit includes the DrammPress, our easy to use hose crimper, with one set of jaws, two spools of 330ft ColorStorm Hose and 12 male and 12 female fittings with ferrules - enough to make 12 hoses.



Yellow - .625
DRM17626
 Min Buy 1 EA

Yellow - .75
DRM17751
 Min Buy 1 EA



Dramm® ColorStorm™ Professional Rubber Hose

This reinforced hose is hexagonal in shape to reduce kinking. The design of the hose allows a user to easily pull free any kinks that may occur. The hexagonal Sure-Grip™ cover creates a softer surface for a more comfortable grip. Each hose has crush-proof, nickel plated, brass fittings for an exact fit that will survive years of use.



Yellow - .625 x 100ft
DRM17303
 UPC 036434173034
 Min Buy 1 EA

Yellow - .625 x 75ft
DRM17203
 UPC 036434172037
 Min Buy 1 EA

Yellow - .625in x 330ft
DRM17999330
 Min Buy 1 SP



Yellow - .625in x Per ft
DRM17999FT
 Min Buy 1 EA

Yellow - .75in x 330ft
DRM17989330
 Min Buy 1 SP

Yellow - .75in
DRM17989FT
 Min Buy 1 EA

Yellow - .75in x 50ft
DRM17013
 UPC 036434170132
 Min Buy 1 EA

Yellow - .75in x 100ft
DRM17313
 UPC 036434173133
 Min Buy 1 EA

Yellow - .75in x 75ft
DRM17213
 UPC 036434172136
 Min Buy 1 EA



Dilution SOLUTIONS™

Other

Dilution Solutions™ DosaCart

Portable fertilization system is perfect for garden centers. Includes: Crash bar, clean-out valve and accommodates the 11, 14, 20, and 40gpm injectors. Injector and hook-up kit sold separately.



Cart Size: 20in x 16in x 45.5in - Tank Size: 15gal -
 Tire Size: 10in No-flat
DOSATHS15-16
 UPC 049961971325
 Min Buy 1 EA



Dilution Solutions™ EcoCart

Portable fertilization system is perfect for garden centers and ideal for spot treatments. Includes 5gal bucket with lid and plumbing. Accommodates the 11 and 14gpm injectors. Injector sold separately.



15in D x 13.5in W x 40in H. - Tank Size: 5gal - Tire
 Size: 7in No-flat.
DOSATHSECO
 Min Buy 1 EA



Dilution Solutions™ EcoCart - 11 GPM

Portable fertilization system is perfect for garden centers and ideal for spot treatments. Includes 5gal bucket with lid, 11gpm injector and plumbing.



15in D x 13.5in W x 40in H. - Tank Size: 5gal Tire
 Size: 7in No-flat.
DOSATHSECOD25F1
 Min Buy 1 EA





Dilution SOLUTIONS™

Other

Dosatron® Mini Maintenance Kit

Mini maintenance kit for D14MZ2 Injector.



For Injector Model D14MZ2

DOSATPJD116MINI-H

Min Buy 1 EA



Dosatron® Seal Kit

Seal kit for the 40gpm D8R injector.



For Injector Model #D8R

DOSAT8PJ052VF

Min Buy 1 EA



Dosatron® Injection Seal Kit

Injection seal kit for D14MZ2 Injector.



For Injector Model D14MZ2

DOSATPJD116VF

Min Buy 1 EA



Dosatron® Plumbing Kit

Plumbing kit for the Dilution Solutions™ DosaCart. Dosatron® unit is sold separately.



For the Dilution Solutions™ DosaCart

DOSATHSPK58

Min Buy 1 EA



Dosatron® Injector

Non-electrical proportional injector provides the perfect solution for: fertilizers, insecticides, fungicides, algicides, acids, wetting agents, disinfectants, and spraying. This water activated injector includes: Mounting bracket, suction hose, weighted strainer and quick start guide.



6.3125in x 19.125in - 14gpm

DOSATD14MZ2VFII

UPC 049961983212

Min Buy 1 EA



Dosatron® Injector

Non-electrical proportional injector provides the perfect solution for: fertilizers, insecticides, fungicides, algicides, acids, wetting agents, disinfectants, and spraying. Includes: Bypass, mounting bracket, suction hose, weighted strainer and quick start guide.



7.5in X 24in - 20gpm

DOSATD45RE15VFII

UPC 049961971332

Min Buy 1 EA



Dosatron® Injector

Non-electrical proportional injector provides the perfect solution for: fertilizers, insecticides, fungicides, algicides, acids, wetting agents, disinfectants, and spraying. This water activated injector includes: Set of legs, manual bypass, suction hose, weighted strainer, vacuum breaker and operating manual.



15in x 42in without Legs - 15in x 55in with Legs - 100gpm - Pipe Size: 2in NPT Thread

DOSATD20SVFII

UPC 049961971301

Min Buy 1 EA



Dosatron® Injector

Non-electrical proportional injector provides the perfect solution for: fertilizers, insecticides, fungicides, algicides, acids, wetting agents, disinfectants, spraying. This water activated injector includes: Mounting bracket, suction hose, weighted strainer and operating manual.



6.125in x 14in - 11gpm - Pipe Size: .75in NPT Thread

DOSATD25F1VFII

Min Buy 1 EA



Dosatron® Injector

Non-electrical proportional injector provides the perfect solution for: fertilizers, insecticides, fungicides, algicides, acids, wetting agents, disinfectants, and spraying. Includes: Mounting bracket, suction hose, weighted strainer and quick start guide. Bypass is optional.



8.5in X 25.25in - 40gpm

DOSATD40MZ2VFII

Min Buy 1 EA





Dilution SOLUTIONS™

Other

Dosatron® By-Pass

Replacement by-pass for D14M22 injector.



For Injector Model D14M22

DOSATMPDI196

Min Buy 1 EA



Dilution Solutions™ Li'l Bud-D

Portable fertilization system is perfect for spot treatments. Includes 5gal bucket with lid. Accommodates the 11 and 14gpm injectors. Injector and hook-up kit sold separately.



22in D x 19in W x 44 1/2 H. Tank Size: 5gal. Tire Size: 10in No-flat

DOSATHS15-5

Min Buy 1 EA



Dilution Solutions™ Li'l Bud-D Quick Hook-Up Kit

For use with the Li'l Bud-D portable fertilizer system. Fits 11gpm and 14gpm injectors. Includes: Filter, check valve, clamp, 5/8in hoses, elbows, a straight 5/8in barb to 3/4in NPT, Velcro strap and Teflon tape. Dosatron injector not included.



DOSATHSPK58LB

Min Buy 1 EA



Dilution Solutions™ Filter Kit for Dosatron® System

200 mesh (80 micron) filter kit includes a filter with a cleanout valve and hose couplings for quick hook-up.



.75in - .79gpm

DOSATAKF5AP11KIT-A

UPC 049961970908

Min Buy 1 EA

For Injector Model D45RE

DOSATAKF5AP20KIT

UPC 049961978140

Min Buy 1 EA



Dosatron® Plumbing Kit

Plumbing kit for the Dilution Solutions™ DosaCart. Dosatron® unit is sold separately.



For the Dilution Solutions™ DosaCart

DOSATHSPK58

Min Buy 1 EA





Components & Tips

Netafim™ 4-Way Flat Manifold Assembly

24in tubing flat mod assembly and standard stakes. Sold in packs of 25



24in - With Angle Arrow Dripper

NET40201-003600

Min Buy 1 EA



Netafim™ 4-Way Flat Manifold Assembly

24in tubing flat mod assembly and short stakes. Sold in packs of 25



4 x 24in - With Short Angle Arrow Dripper

NET40201-003800

Min Buy 1 EA



Netafim™ 4-Way Manifold Assembly

18in tubing and short stakes, dripper sold separately. Sold in packs of 25.



18in

NET40201-002600

Min Buy 1 EA



Netafim™ 4-Way Manifold Assembly

18in and 30in tubing and short stakes, dripper sold separately. Sold in packs of 25.



2 x 18in and 2 x 30in

NET40201-003200

UPC 049961975712

Min Buy 1 EA

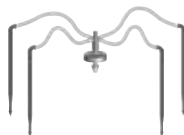

Netafim™ 4-Way Manifold Assembly

30in tubing and short stakes, dripper sold separately. Sold in packs of 25.



4 x 30in

NET40201-004400

Min Buy 1 EA

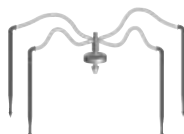

Netafim™ 4-Way Manifold Assembly

24in and 48in tubing and short stakes, dripper sold separately. Sold in packs of 25.



Sunview OW

NET014DM-2448F

Min Buy 1 EA

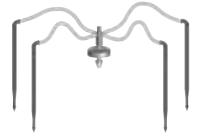

Netafim™ Angle Arrow Dripper Stake

Angle arrow stake.



Angle Arrow Dripper 6in

NET22000-001320

Min Buy 1 EA



Netafim™ Angle Barbed Stake

Angle barbed stake.



NET32000-001806

Min Buy 1 EA



Netafim™ Flat 4-Way Multi-Outlet Dripper Assemblies

Standard with super flex UV white PE tubing.



18in

NET40201-002550

Min Buy 1 EA



Netafim™ Arrow Dripper

Allows placement of drippers exactly where necessary. Allows maximum flexibility in greenhouse and nurseries (with soft PE micro-tubes). Unique flow channel down the length of the stake directs water into the container. Features pointed end for easy container insertion.



Arrow Dripper Straight

NET22000-001120

Min Buy 1 EA



Netafim™ Coolnet Pro Fogger Head Assembly

Humidifying or cooling. 4 nozzles with check valve purple pin.



8.1gph - 60psi (Opening Pressure 28psi)

NET63100-058397

Min Buy 1 EA





Components & Tips

Netafim™ Dripper Angle Barbed Stake Assembly

.5gph - Pressure Compensating with CNL Check Valve Feature; Standard with Super Flex UV White PE Tubing. Sold in packs of 25.



24in L

NET40201-020600

Min Buy 1 EA



36in L

NET40201-021000

Min Buy 1 EA

Netafim™ Dripper for 4 Way Assembly

The CNL feature is an internal check valve or non-draining mechanism that eliminates refill and drainage effects. Non-Pressure Compensating Drippers are designed with a barb inlet for easier installation. Features exclusive Turbonet flow path, an innovative concept that provides the dripper's with a very large water passage, allowing contaminants to pass easily through the dripper virtually eliminating clogging.



2gph/CNL

NET21020-001510

UPC 049961986237

Min Buy 1 EA



Netafim™ Dripper Spray Stake Assembly

Pressure compensating with CNL Check Valve Feature; Standard with Super Flex UV White PE tubing. For complete assembly order (1) dripper assembly and (1) PCNL spray stake. Sold in packs of 25.



3.2gph - 48in

NET40201-024700

Min Buy 1 EA



Netafim™ Dripper Stake Assemblies

The CNL feature is an internal check valve or non-draining mechanism that eliminates refill and drainage effects. Standard with Super Flex UV White PE Tubing.



.5 gph - 30in - Pressure Compensating - CNL - Angle Barbed Stake

NET40201-020700

Min Buy 1 EA



Netafim™ Electric Valves 24 VAC

Simple to operate and maintain. Robust flow control stem and manual override. Reliable even in harsh conditions. Stable solenoid. Tight sealing valve with fully supported diaphragm. Integral stainless steel EasyClean® filter.



.75in - 24V - Threaded

NET71640-007355

Min Buy 1 EA



1.5in - 24V - Threaded

NET71640-007425

Min Buy 1 EA

1in - 24V - Threaded

NET71640-007406

Min Buy 1 EA



Solenoid for Electric Valves

NET71640-007141

Min Buy 1 EA

Netafim™ Female Sprinkler Adaptor

Used for connection to rigid pipe with .5in threaded connections and Netafim sprinklers.



.5in Thread

NET63000-001210

Min Buy 1 EA



Netafim™ Aqua Pro Control Valve

1" Series 80 Globe Control Valve With Controller



NET71610-013969

Min Buy 1 EA



Netafim™ Grommet

Net grommet



Use with 1.5in or larger PVC

NET00115-000500

Min Buy 1 EA





Components & Tips

Netafim™ Insert Fittings

Dripline and polyethylene fittings.



16mm

NET32500-010720

Min Buy 1 EA



16mm Insert Tee

NET32500-011330

Min Buy 1 EA



16mm Insert Elbow

NET32500-012530

Min Buy 1 EA

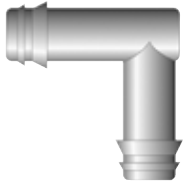
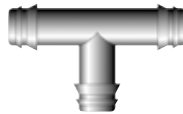

Netafim™ Hanging Assembly for Sprinklers, Mistrs or Foggers

For connection to polyethylene (PE) pipe. Sold in packs of 25.



12in L

NET63000-004070

Min Buy 1 EA

24in L

NET63000-005870

Min Buy 1 EA

30in L

NET63000-006460

Min Buy 1 EA

36in L

NET63000-007170

Min Buy 1 EA

48in L

NET63000-008361

Min Buy 1 EA



Netafim™ HF Vibro-Spray Sprinkler

1/2in female threaded connection.



1gpm / 30psi

NET60500-024470

Min Buy 1 EA



Netafim™ Insert Connector

Insert & Barb



5mm

NET32500-001125

Min Buy 1 EA



Netafim™ Inline Shut-Off Valve

.520 inch plastic shut off for standard 16mm irrigation tubing.



16mm

NET00005-008960

Min Buy 1 EA

.75in

NET00005-008990

UPC 049961986213

Min Buy 1 EA



Netafim™ Line End

Figure 8 line end.



.75in PE

NET78241-002500

Min Buy 1 EA

16mm PE

NET32500-013030

UPC 049961970632

Min Buy 1 EA



Netafim™ Manifolds

Ideal for field applications. To create additional configurations combine the Flat 2-Way or 4-Way Stackable manifold with a 4-Way manifold. The Flat 2-Way manifold is usually combined with the 1gph WPCJL Dripper - .5gph per plant.



4-Way Flat Manifold

NET32000-002570

Min Buy 1 EA



Netafim™ Manual Disc Filter

Grooves in the disc rings crisscross to form a network that traps debris between and on the outside of the discs.



.75in

NET70640-001200

UPC 049961975620

Min Buy 1 EA

1in

NET70641-001600

UPC 049961980273

Min Buy 1 EA



Netafim™ Misting Head

VibroNet mister with 9.2gph at 32psi. Blue nozzle. Sold in packs of 25.



Misting & Sprinkling Head - Blue Nozzle - 9.2gph at 32psi

NET64300-001010

Min Buy 25 EA





Components & Tips

Netafim™ Misting Head

VibroNet mister with 11.75gph at 32psi. Green nozzle. Sold in packs of 25.



Misting & Sprinkling Head - Green Nozzle - 11.75gph at 32psi

NET64300-005010

Min Buy 25 EA



Netafim™ NetBow™ Drip Ring

An innovative user friendly container irrigation multi outlet dripper arc with high clogging resistance and superb water distribution.



5in - .53GPH - 14.5PSI

NET77470-000142

Min Buy 1 EA



10in - 0.53GPH - 14.5 PSI

NET77470-000106

Min Buy 1 EA



Netafim™ PC Double Spray Stake

Pressure compensating spray stake.



Grey - 6.6gph

NET22500-002230

Min Buy 1 EA



Netafim™ PC Single Spray Stake

Pressure compensating spray stake.



Plum - 3.2gph

NET22500-002030

Min Buy 1 EA



Netafim™ Shut Off

Shut off cap for woodpecker dripper



NET32000-001435

Min Buy 1 EA



Netafim™ Pre-Assembled Dripper

Offers cost savings derived from minimizing run off often associated with traditional watering methods.



18in -.5gph WPCJ Pressure Compensating Dripper

NET40201-013900

Min Buy 1 EA

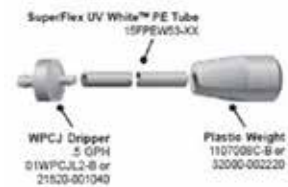

48in -.5gph WPCJ Pressure Compensating Dripper

NET40210-01300

Min Buy 1 EA

Netafim™ Pressure Compensating Spray Stakes

All units stop and start at the same time. Features one directional spray. The 8in spray stake fits firmly into the media and can be angled to adjust the spray pattern according to the pot size.



3.2gph Plum Dripper Assembly - 36in Line

NET40201-002020

Min Buy 1 EA



6.6gph Grey Dripper Assembly - 36in Line

NET40201-002320

Min Buy 1 EA



Netafim™ VibroNet Sprinkler

Sprinkler with leak prevention device.



Green- with Check Valve - 11.7gph - 32psi

NET64300-005110

Min Buy 1 EA



Netafim™ Slimline EZ Close™ Weight Assembly

One-hand, EZ close shut-off of individual baskets - prevents water and fertilizer spillage and waste. Snag-free slim design for easy retrieval from plants at harvest - no more lost weights. 94% flow uniformity from the first basket to the last in any system. Each pre-assembled SlimLine EZ Close™ Weight assemblies include: .5gph WPCJ Dripper with built-in check valve, Super Flex UV White™ PE tubing and weight. Sold in packs of 25.



Pre-Assembled - 18in L

NET40201-015402

Min Buy 1 EA





Components & Tips

Netafim™ SpinNet Sprinkler & Check Valve Head Assembly

SpinNet Sprinklers offer drip-less operation – the plants below are not damaged from water dripping of the sprinkler. Sprinklers hang below the supply pipe, preventing wetting of the pipe and dripping onto the plants below. SpinNet Sprinklers with Check Valve consist of a mist control, body and spinner. The mist control determines the flow rate and eliminates misting that distorts the sprinkler pattern. The spinner determines the radius which allows the sprinkler to handle bay width applications from 10ft to 38ft. Check valve provides instantaneous on-off and prevents line drainage and prevents the sprinkler line from draining onto the plants below after shut-down. It opens at 28 psi and closes at 13 psi. All sprinkler solutions are based on average sprinkler working pressure of 30psi and spacing between the sprinklers of three feet.



R-R-GY – (03551200070L-B) Red Mist Control, Red Body, Grey Spinner with Check Valve - 23.4gph

NET64200-001302

Min Buy 1 EA



Netafim™ SpinNet Sprinkler Head Assembly & Check Valve

SpinNet Sprinklers offer drip-less operation – the plants below are not damaged from water dripping off the sprinkler. Sprinklers hang below the supply pipe, preventing wetting of the pipe and dripping onto the plants below. SpinNet Sprinklers with Check Valve consist of a mist control, body and spinner. The mist control determines the flow rate and eliminates misting that distorts the sprinkler pattern. The spinner determines the radius which allows the sprinkler to handle bay width applications from 10ft to 38ft. Check valve provides instantaneous on-off and prevents line drainage and prevents the sprinkler line from draining onto the plants below after shut-down. It opens at 28psi and closes at 13psi. All sprinkler solutions are based on average sprinkler working pressure of 30psi and spacing between the sprinklers of three feet.



BR-BR-GN - (03551600090GL-B) Brown Mist Control, Brown Body, Green Spinner with Check Valve - 23.4gph

NET64200-014005

Min Buy 1 EA



R-R-BL - (0355120070BL-B) Red Mist Control, Red Body, Blue Spinner with Check Valve - 18.4GPH

NET64200-032030

Min Buy 1 EA



Netafim™ Sprinkler Head Assembly

SpinNet Sprinklers offer drip-less operation – the plants below are not damaged from water dripping off the sprinkler. Sprinklers hang below the supply pipe, preventing wetting of the pipe and dripping onto the plants below. SpinNet Sprinklers with Check Valve consist of a mist control, body and spinner. The mist control determines the flow rate and eliminates misting that distorts the sprinkler pattern. The spinner determines the radius which allows the sprinkler to handle bay width applications from 10ft to 38ft. Check valve provides instantaneous on-off and prevents line drainage and prevents the sprinkler line from draining onto the plants below after shut-down. It opens at 28psi and closes at 13psi. All sprinkler solutions are based on average sprinkler working pressure of 30psi and spacing between the sprinklers of three feet.



R-R-GN - (03551200070GL-B) Red Mist Control, Red Body, Green Spinner with Check Valve - 18.4GPH

NET64200-010805

Min Buy 1 EA



BR-BR-BL - (0355160090BL-B) Brown Mist, Brown Body, Blue Spinner with Check Valve - 23.4GPH

NET64200-033030

Min Buy 1 EA



BR-Y-GY - (03552000090GL-B) Brown Mist Control, Yellow Body, Grey Spinner with Check Valve - 23.4GPH

NET64200-001805

Min Buy 1 EA



Netafim™ Thinwall Dripline Fittings and Connectors

Space-it barb connector, grommet and shut-off valve.



.636in

NET00115-006251

Min Buy 1 EA



Netafim™ Retrofit Adapter

Connects Netafim head assemblies to other manufacturer's fitting.



Female x Female - Dan to Micronet

NET63000002515

Min Buy 1 EA





Components & Tips

Netafim™ Woodpecker Dripper

Designed with a barb inlet for easier installations. Features Netafim's exclusive Turbonet flow path, an innovative concept that provides the dripper's with a very large water passage, allowing contaminants to pass easily through the dripper virtually eliminating clogging. Color-coded for easy flow identification.



.5gph - Red
NET01WPS2-B
 Min Buy 1 EA

Netafim™ Woodpecker Pressure Compensating Junior Dripper Barbed Outlet

Pressure compensating dripper.



.5gph - Red
NET21520-001040
 Min Buy 1 EA



Netafim™ Woodpecker Pressure Compensating Junior Dripper

Green pressure compensating dripper.



2gph
NET21520-001740
 Min Buy 1 EA



Netafim™ Woodpecker Pressure Compensating Junior Dripper

Grey pressure compensating dripper.



1gph
NET21520-001410
 Min Buy 1 EA



Netafim™ Goof Plug

Dual goof plug



.43mm
NET32000-001010
 UPC 049961970380
 Min Buy 1 EA



Components & Tips

Netafim™ TWD Fittings With Blue Rings

Thinwall dripline fittings - TWD.



TWD Coupling
NET32500-016770
 Min Buy 1 EA



Netafim™ TWD Fittings With Blue Rings

Line end plug with ring.



TWD Line End
NET32500-016490
 Min Buy 1 EA



Tubing

Netafim™ Space-It Dripline

Drip system for watering potted plants. It's a thinwall drip line with pre-spaced drippers designed to be placed directly over the top of pots with the location of each dripper visibly marked on the tubing. Positioning of the pots (plants) is quick and easy - just place the pot under the mark on the drip line - saving up to 20% in installation labor costs.



18in Spacing - 8ml - .4gph - 9,000ft per Roll
NET16523-000104
 Min Buy 1 RL



20in Spacing - 8ml - .4gph - 9,000ft per Roll
NET16523-000105
 Min Buy 1 RL

Netafim™ 16mm Pre-Punched Tubing .520in diam

Black polyethylene pre-punch tubing.



12in Spacing - 1000ft roll
NET8452062012
 Min Buy 1 RL



36in Spacing - 1000ft roll
NET84520620-36
 Min Buy 1 EA

Netafim™ Oval Tubing

350ft length; 62lbs. Netafim Oval Tube is a durable and reliable round manifold which unfolds for easy installation and rolls up for relocation. Tubing is black in color with white stripes.



1.5in - 42psi
NETOT 1.50-42-350W
 Min Buy 1 RL





Netafim™ Super Flex UV White™ Polyethylene Micro-Tubing

Flexible tubing fully UV resistant. Made from the highest quality low density resins, the white tubing is opaque to prevent algae growth, withstand heat and harsh chemicals while producing cooler water temperatures.



5/32mm - White - 1,000ft per Roll

NET40001-002500

Min Buy 1 RL



Tubing

Netafim™ Black Polyethylene Tubing

Low density. To be used in irrigation systems.



.75in - .82in Diam - Black - 100ft per Roll

NET40510-000070

Min Buy 1 RL



.75in - .82in Diam - Black - 500ft per Roll

NET40510-000018

UPC 746108088394

Min Buy 1 RL

16mm - .52in Diam - Black - 100ft per Roll

NET40510-000024

UPC 049961978614

Min Buy 1 RL

16mm - .52in Diam - Black - 500ft per Roll

NET40510-000025

Min Buy 1 RL

1in - 1.06in Diam - Black - 100ft per Roll

NET40510-000085

Min Buy 1 RL

1in - 1.06in Diam - Black - 500ft per Roll

NET40510-000020

Min Buy 1 RL

1.67mm - Black - 3,000ft per Roll

NET40001-002000

UPC 049961981362

Min Buy 1 RL

Netafim™ Tubing

Made from the highest quality low density resins, the white tubing is opaque to prevent algae growth, withstand heat and harsh chemicals while producing cooler water temperatures.



16mm - .52in Diam - White - 500ft per Roll

NET40510-000100

Min Buy 1 RL



Netafim™ Pre-Cut Super Flex UV White™

Netafim Polyethylene Tubing is made from quality low density polyethylene resins. With Netafim's stringent quality controls, every coil undergoes a battery of tests and over 30 quality checks before leaving the factory. This means you'll receive the highest quality product with each and every coil. A soft, 5/32mm tubing with improved flexibility and all the advantages of PE tubing - UV resistant, completely opaque to prevent algae growth and able to withstand heat and harsh chemicals. The 5/32mm tubing is used with all dripper and spray stake assemblies.



White - 1.67mm - Pre-Cut 36in Lengths - Sold in Packs of 100 - 3mm Inside Diameter - 5mm Outside Diameter

NET40001-003200

Min Buy 1 EA





Components & Tips

Amiad® Filter with Valve

Plastic filter for irrigation system. Easy maintenance, corrosion resistance, excellent mechanical strength and low pressure loss. Can be used in a variety of systems.



.75in - 155 Mesh - 100 Micron - Yellow

AMIAD1-703-4151-8010

Min Buy 1 EA

1in - 120 Mesh - 130 Micron - Red

AMIAD1-1201-1151-1013

Min Buy 1 EA



Amiad® Mini Sigma Filter

Automatic self-cleaning filter for irrigation system, flushes at low pressures. Easy maintenance, corrosion-proof, excellent mechanical strength and low pressure loss. Can be used in a variety of systems.



2in Mini Sigma Angle or On-Line - 80-500 micron

AMIAD55000000002

Min Buy 1 EA

Amiad® Scanaway Filter

Semi-automatic filter eliminates the need for turning off the water and extracting the filter screen for rinsing. Provides low pressure loss with no interruption of the process water flow during cleaning. Fitted with a "Clogging Indicator".



2in - 155 Mesh - 100 micron - Yellow

AMIAD30002000025

Min Buy 1 EA



Water Treatment

CCG pH Up

pH Up is the most concentrated pH adjuster there is on the market. Perfect for commercial reservoirs. Maximum strength pH Up consists of a 75% concentrated potassium hydroxide solution that quickly raises pH levels with its gentle, but very strong formula.



1gal

CCG5128

UPC 653341165046

Min Buy 4 EA

32oz

CCG5032

UPC 653341165343

Min Buy 12 EA



Central Coast Garden Products pH Down

Central Coast Garden Products' pH Down Pure Concentrate is the most concentrated pH adjuster there is on the market. Perfect for commercial reservoirs. Our maximum strength pH Down consists of a 75% concentrated Phosphoric Acid solution that quickly lowers pH levels with its gentle, but very strong formula. pH levels outside recommended ranges can lead to nutrient lockout and nutrient deficiencies resulting in stunted growth and poor appearance. Control pH levels, minimize problems and maximize your plants' full potential with Central Coast Garden Products' pH Down solution.



1gal

CCG3128

UPC 653341165442

Min Buy 4 EA

32oz

CCG3032

UPC 653341165541

Min Buy 12 EA





Watering Tools & Supplies

Blumat Bottle Adapter Plant Watering Stake

Much better than the wine bottle versions because Blumats are so much easier to refill: just cut the bottom off plastic bottle and fill with your regular watering can. Better than the globe spikes because these disperse the water evenly, not just through a hole in the bottom. Just fit this adapter into almost any standard plastic bottle, fill the bottle with water and push into the soil near a plant. The porous cone will slowly start to distribute water throughout the day.



Regular - 200mil during 24hrs

SUSIG15480

UPC 900268302030

Min Buy 8 EA



Blumat Bottle Adapter Plant Watering Stake

Much better than the wine bottle versions because Blumats are so much easier to refill: just cut the bottom off plastic bottle and fill with your regular watering can. Better than the globe spikes because these disperse the water evenly, not just through a hole in the bottom. Just fit this adapter into almost any standard plastic bottle, fill the bottle with water and push into the soil near a plant. The porous cone will slowly start to distribute water throughout the day.



XL - 300mil during 24hrs

SUSIG15481

UPC 900268302220

Min Buy 5 EA



Blumat Classics Junior - Automatic Watering Stakes

Take a vacation and let your plants look after themselves. Blumat Plant Savers ensure a constant supply of water. They automatically supply just the right amount - never too much or not enough. Your plants will love it. They won't experience the drying out that stunts growth or the over-watering that squeezes the air out of the soil and keeps them from "breathing" properly.



3pk

SUSIG14605

UPC 900268301030

Min Buy 12 EA



Blumat Classics Junior Counter Display Box

This display box is great for stores. It's also the best way to buy these for people who already know how well they work and want to get more than just a few. Take a vacation and let your plants look after themselves. Blumat Plant Savers ensure a constant supply of water. They automatically supply just the right amount - never too much or not enough. Your plants will love it. They won't experience the drying out that stunts growth or the over-watering that squeezes the air out of the soil and keeps them from "breathing" properly.



25ct

SUSIG14603

UPC 900268301250

Min Buy 1 EA



Blumat Classics Junior XL - Automatic Watering Stakes

Take a vacation and let your plants look after themselves. Blumat Plant Savers ensure a constant supply of water. They automatically supply just the right amount - never too much or not enough. Your plants will love it. They won't experience the drying out that stunts growth or the over-watering that squeezes the air out of the soil and keeps them from "breathing" properly.



2pk

SUSIG15507

UPC 900268301052

Min Buy 5 EA



Blumat Plant Spray Mister

Probably the best mister - compact, beautiful and works like a charm. The famous Haws mister but not in the Haws gift box. People tend to lose their plastic bottle misters (which also tend to quickly break and stop working) because they are so ugly and we're always hiding them from view. This one looks so good that there is no problem keeping it in plain view.



Brass - Holds 10fl oz

SUSAG15224

UPC 501286829150

Min Buy 4 EA

Copper - Holds 10fl oz

SUSAG15907

UPC 712324631425

Min Buy 4 EA





Water Treatment

Cutting Edge Solutions® pH Down™

Precision buffering for pH adjustment. pH Down™ is an acidic liquid which lowers water and nutrient solution pH.



32oz Bottle
CESCE3601
 Min Buy 1 EA

1gal Bottle
CESCE3604
 Min Buy 4 EA



Cutting Edge Solutions® pH Up™

Precision buffering for pH adjustment. pH Up™ is an alkaline liquid which raises water and nutrient solution pH.



32oz Bottle
CESCE3701
 Min Buy 1 EA

1gal Bottle
CESCE3704
 Min Buy 4 EA



CELEBRATING
20 YEARS
 OF SUCCESS



- ENHANCE YIELD •
- ELEVATE TERPENES •
- AUTOMATE IRRIGATION •

WWW.CUTTINGEDGESOLUTIONS.COM



FLEXZILLA®

Watering Tools & Supplies

Flexzilla® Pro Retractable Water Hose Reel with Levelwind™ Technology

Featuring Levelwind™ – Flexzilla's unique winding system that automatically layers hose back and forth across the reel ensuring that the hose is coiled smoothly, easily...every time – and includes Flexzilla® water hose and lead-in hose.



ZillaGreen™ - .5in Diam x 70ft Hose
LEGL8340FZ
 UPC 092329083406
 Min Buy 1 EA



Flexzilla® SwivelGrip® Garden Hose

Flexzilla® makes it easier to work around your home and lawn. SwivelGrip® action eliminates twists that occur when uncoiling a hose. Conventional garden hoses can trap coils that tighten into kinks as you move across the yard. SwivelGrip releases these trapped coils because the hose rotates freely inside the grip. The large, comfortable gripping surface on both ends of the hose makes connections much easier to turn and tighten. SwivelGrip hoses are also drinking water safe.



.625in Diam x 10ft L
LEGHFZG510YWS
 UPC 092329510100
 Min Buy 10 EA



.625in Diam x 50ft L
LEGHFZG550YWS
 UPC 092329510506
 Min Buy 5 EA

.625in Diam x 100ft L
LEGHFZG5100YWS
 UPC 092329511008
 Min Buy 3 EA

DOSMATIC®

Other

Dosmatic™ MiniDos Injector

The MiniDos low-mid flow, fluid (water)-driven proportional injectors offer an ideal alternative to traditional, non-electric technology. These injectors are compact and offer the widest range of injection ratios.



2.5% - 12gpm

DOSM112602

Min Buy 1 EA



Dosmatic™ Advantage 30 Injector

The Advantage 30 operates without electricity to precisely inject liquid concentrates into a water supply line using fluid flow as the power source. Features: chemicals are thoroughly mixed before output, ratio easily adjustable and composite body construction.



2.5% - 30gpm

DOSMSPV0182

Min Buy 1 EA



Dosmatic™ SuperDos 45 Injector

The SuperDos mid-high flow, fluid (water)-driven proportional injectors offer an ideal alternative to traditional electric technology.



2.5% - 45gpm

DOSM113212

Min Buy 1 EA



Dosmatic™ SuperDos 20 Injector

The SuperDos mid-high flow, fluid (water)-driven proportional injectors offer an ideal alternative to traditional electric technology.



2.5% - 20gpm

DOSM113205

Min Buy 1 EA



Dosmatic™ SuperDos 30 Injector

The SuperDos mid-high flow, fluid (water)-driven proportional injectors offer an ideal alternative to traditional electric technology.



2.5% - 30gpm

DOSM113209

Min Buy 1 EA



Water Treatment

Earth Juice® Crystal pH Down

pH decrease adjuster. Eliminates the use of synthetic and messy liquid pH adjusters. Use to adjust the pH of fertilizers and plant micronutrients foliar solutions. Highly concentrated.



1.6lb

EXC100538621

UPC 727644001360

Min Buy 12 EA

7.8lb

EXC100538622

UPC 727644001377

Min Buy 4 EA



Earth Juice® Crystal pH Up

pH increase adjuster. Eliminates use of harsh synthetic and messy liquid pH adjusters. Use to adjust the pH of fertilizers and plant micronutrient foliar solutions. Highly concentrated.



2lb

EXC100538618

UPC 727644001339

Min Buy 12 EA

10lb

EXC100538619

UPC 727644001346

Min Buy 4 EA



DAKINE 420

HIGH YIELD SCIENCE

Water Treatment

DaKine 420 Dakine 420 pH Down

If your Ph is getting too high, the best strategy is to bail out and drop down. Ph Down is a very safe and buffered, 100% soluble product derived from urea phosphate. Dial in the 17-42-0 nutrient combo and watch your numbers drop.



1,000g
DAKPHDOWN1000
UPC 728028467123
Min Buy 4 EA

10,000g
DAKPHDOWN10KG
UPC 728028467130
Min Buy 1 EA

50kg
DAKPHDOWN50KG
UPC 728028467147
Min Buy 1 EA

250kg
DAKPHDOWN250KG
UPC 850030593160
Min Buy 1 EA



DaKine 420 Dakine 420 pH Up

Strap in and light the fuse, this Ph Up formula is rocket fuel to kick your plants in the acid! Derived from powdered potassium carbonate, this 100% soluble, safe booster puts you in the driver's seat as far toward planet alkaline as you need to go.



1,000g
DAKPHUP1000
UPC 728028467093
Min Buy 4 EA

10,000g
DAKPHUP10KG
UPC 728028467109
Min Buy 1 EA

50kg
DAKPHUP50KG
UPC 728028467116
Min Buy 1 EA

250kg
DAKPHUP250KG
UPC 850030593153
Min Buy 1 EA



Water Treatment

GreenGro™ Water Conditioner

GreenGro Premium Water Conditioner balances the conditions in water that will greatly improve your ability to grow healthier, more productive plants. Because many cities treat their tap water, it may include chlorine, chlorides, chloramines, and other sanitizing ingredients. Additionally, trace heavy metals and other toxic agents may be found. GreenGro Water Conditioner solves all of these common problems by eliminating or neutralizing them on contact.



8oz
GGBWC4008
UPC 857834003079
Min Buy 10 EA

32oz
GGBWC4032
UPC 857834003147
Min Buy 10 EA



Watering Tools & Supplies

Gardener Select® Deluxe Shower Head Watering Wand

The ultra-fine spray pattern is perfect for watering plugs and delicate young plants. Made with a sturdy metal wand. Control the water flow with the quarter-turn valve. The foam grip provides comfort and ease of use. Includes removable micro hole disc.



24in
GSARH24SWN
UPC 049121375048
Min Buy 6 EA



Water Treatment

Ecological Laboratories® Microbe-Lift® Super Dechlorinator Plus

Will remove and neutralize chlorine, destroy chloramines, detoxify heavy metals (e.g. copper), adds a multipart skin slime replacer, adds essential electrolytes and alkalinity (acid-neutralizing capacity) boosters.



16oz
ECLDECHL16
UPC 097121202192
Min Buy 12 EA

32oz
ECLDECHL32
UPC 097121202208
Min Buy 12 EA



Ecological Laboratories® MICROBE Life® HYDROPONICS Premium Dechlorinator Plus

A full-function water conditioner that will neutralize chlorine, destroy chloramines and detoxify heavy metals (i.e. copper). Formulated with R/O and UV sterilized water.



16oz
ECLPH21359
UPC 097121213594
Min Buy 12 EA

32oz
ECLPH21360
UPC 097121213600
Min Buy 12 EA



Ecological Laboratories® Microbe-Lift® Dechlorinator Plus

Microbe-Lift Dechlorinator Plus is the Ultimate in Water Conditioning. Microbe-Lift Dechlorinator Plus will instantly dechlorinate and detoxify your pond water.



1gal
ECLDECHL1GAL
UPC 097121202215
Min Buy 4 EA



Ecological Laboratories® MICROBE Life® HYDROPONICS Premium Dechlorinator Plus

A full-function water conditioner that will neutralize chlorine, destroy chloramines and detoxify heavy metals (i.e. copper). Adds essential electrolytes and alkalinity boosters (acid neutralizing). Formulated with R/O and UV sterilized water.



1gal
ECLPH21361
UPC 097121213617
Min Buy 4 EA

2.5gal
ECLPH21362
UPC 097121213624
Min Buy 2 EA



PACE 49 Inc.

Water Treatment

UpTake™ Soil Wetting Agent & Surfactant

UpTake™ is a biodegradable soil adjuvant and wetting agent designed for turf grass, trees, nursery stock, field crops, greenhouses and orchards. UpTake™ increases penetration of water through soil, resulting in improved root growth and plant quality.



5gal
PAC4919-0603T
Min Buy 1 PA



HYDRO LIFE®

WATER FILTRATION SYSTEMS

Water Treatment

C/85 Refill Filter

C/85 hose line garden filter in 6 pack PDQ box with out flex hose. Refill for 52700. easily attaches to any water hose or water spigot. Effectively reduces Chlorine and chloramines, chemicals, salts and heavy metals, sediment, rust flakes (iron) and organic matter.



Hose line garden refill filter

HYL52701

UPC 014717527019

Min Buy 6 EA



C/85 Twin Filter System

The Hydro Life Hydroponics Twin Filtration System is perfect for urban gardens, organic veggies and flowers. The two step filter system includes a micron pre-filter and Catalytic Carbon filter with KDF 85 media. The pre-filter is a sacrificial filter that removes heavy sediment from water, helping to extend the life of the KDF 85 filter. The KDF 85 filter has Catalytic Carbon filtration to provide you with safer, cleaner water from any potable source and KDF 85 to help prevent bacteria growth when the filter is not in use. Removing chlorine and other contaminants from your irrigation water promotes larger and faster root growth, which translates to larger and faster plant growth.



Garden water filtration

HYL52710

UPC 014717527101

Min Buy 1 EA



C/85 XL Hose Line Filter with Flex Hose

C/85 XL higher flow and higher capacity hose line garden filter with flex hose in retail box. Higher flow rate up to 10GPM. And higher capacity filter up to 30,000 gallons of use before replacing. Easy to use attached to any standard garden hose or water spigot. Effectively reduces Chlorine and chloramines, chemicals, salts and heavy metals, sediment, rust flakes (iron) and organic matter.



Garden - hydroponic water filter

HYL52702

Min Buy 2 EA



Hydro Life C/85 with flex hose

C/85 hose line garden water filter with flex hose in retail box. Easily attached to any water hose or water spigot. Effectively reduces Chlorine and chloramines, chemicals, salts and heavy metals, sediment, rust flakes (iron) and organic matter.



Garden - Hydroponic water filter

HYL52700

UPC 014717527002

Min Buy 3 EA



Hydro Life HydroPonic C-85 Filter

The Hydro Life Hydroponics C-85 XL Inline Hose Filter is perfect for urban gardens, organic vegetables, hydroponic gardens and more vibrant flowers. Containing catalytic carbon and KDF 85, this filter can reduce up to 98% of chloramines and heavy metals from your water source. KDF 85 bonds/traps heavy metals and can help prevent bacteria growth when the filter is not in use to extend the overall life of your hydroponic filter.



Display

HYL61114

Min Buy 1 DS

Hydro Life Hydroponic KDF 85 Cartridge

Replacement cartridge for C/85 Twin Filter System



HYL52712

UPC 014717527125

Min Buy 6 EA



Hydro Life Hydroponic Reverse Osmosis Replacement Cartridge

Replacement cartridge for Reverse Osmosis Filter System.



HYL52716

UPC 014717527163

Min Buy 4 EA



Water Treatment

Hydro Life Hydroponic Sediment Pre-Filter Cartridge

A spun polypropylene sediment filter designed for use in the first step of your hydroponic filtration set up. A cost-effective solution to help remove sediment before it reaches the premium carbon filter cartridge or RO membrane, preventing it from becoming clogged and ineffective. Filters out sediment and other large particles. Helps extend the life of your downstream filters. Saves money on filter replacement costs by extending their life. 6 GPM Flow Rate



HYL52711

UPC 014717527118

Min Buy 6 EA

Hydro Life Hydroponic Twin Reverse Osmosis Filter System

Growing with pure water and adding nutrients at the grower's discretion make growing more predictable. The Hydro Life Hydroponics RO 100 Filter System removes 99% of all contamination in water through reverse osmosis. This three step system includes a micron pre-filter, premium Catalytic Carbon filter with KDF 85 media and hydron membrane. This RO 100 system removes the same contaminants as the Twin system, but the addition of the hydron membrane, which rejects everything but water molecules, leaves a final product that has 99% reduction in parts per million contaminants in water. The RO 100 Water Filter System is easy to install and includes garden hose connector, mounting bracket, blue RO filtered water line, black wastewater line, white inlet line and filter wrench, all preinstalled and ready to go.



HYL52715

UPC 014717527156

Min Buy 1 EA

Watering Tools & Supplies

GARDENA® Twin-Tap Connector

Part of the Original GARDENA system. Twin tap connector - quick connection for easy on and off. Works with 5/8in and 1/2in garden hoses, sprinklers and spray nozzles. Includes two hose connectors (36917). For operating two watering accessories at the same time with two fully adjustable outlets.



GCL36938G

UPC 066283369388

Min Buy 12 EA



GARDENA® Classic Hose Connector with Control Valve

A connecting device that allows you to easily change hose end accessories. The water flow can be directly controlled and adjusted at the control valve and can be easily exchanged even with high water pressure.



Suitable for 5/8 & 3/4in Hoses

GCL36943

UPC 066283369432

Min Buy 10 EA



GARDENA® Water Smart Flow Meter

Digital counter keeps track of water usage. Easy to read LCD display.



GCL9188U

UPC 066283091883

Min Buy 4 EA



THE MUSCLE IS HERE

Legendary microbes for your heavy lifting needs



BLACKSMITH
BIOSCIENCE



www.blacksmithbio.com



EQUIPMENT

DRAMM

Sprayers

Dramm® Hydra™ 50 Sprayer

The Dramm Hydra Multi-spray Hydraulic Sprayer is a high volume hydraulic sprayer capable of performing a variety of tasks. The Hydra is perfect for the application of insecticides, fungicides, growth regulators, fertilizers, disinfectants and other chemicals. With a pump output of 4gpm, the Hydra offers enough volume to utilize a choice of guns and agitate the tank at the same time. The pump has a maximum operating pressure of 550psi with a fully adjustable regulator. This allows for a variety of droplet sizes and spray distances. The Hydra uses a close-coupled pump to eliminate belt or chain maintenance and is run by a sealed 1.5hp electric motor. The standard gun offers a choice of patterns with an output of 1.3gpm. Different nozzle tips are available for lower or higher flow rates. The Hydra comes standard with a 50 gallon tank on a maneuverable cart with rear casters for easy turning when full. The unit includes 150ft of hose on a variable drag reel. 250ft hose length available.



Electric Motor, Single Reel, 150ft 1/4in
Hose, 50gal Tank
DRMHYDRA50150
Min Buy 1 EA



Dramm® Hydra Sprayer

The Dramm Hydra Multi-spray Hydraulic Sprayer is a high volume hydraulic sprayer capable of performing a variety of tasks. The Hydra is perfect for the application of insecticides, fungicides, growth regulators, fertilizers, disinfectants and other chemic



50gal/150ft Hose - 500PSI - 120 Volt
DRMHYDRA50150CRF
Min Buy 1 EA

Dramm® Hydra™ 200 G Sprayer

The Hydra200G - 200 gallon hydraulic sprayer extends the Hydra line to larger spray capacities. Utilizing our durable and powerful triplex pump, the Hydra has capacity to utilize two hoses at a time when powered by a gasoline engine. Each reel can fit up to 250ft of hose. The 200G can also be mounted with a single, larger reel for up to 300ft capacity. The Remote Wind reel can be attached for automatic winding of the hose during spray application. Contact BFG for custom quote!



Gas Engine, 250ft Hose
DRMHYDRA200G250
Min Buy 1 EA



In an effort to service customers using high levels of oxidizers in their spray equipment that face testing for heavy metals, **Dramm conducted trials with their Hydra line of spray equipment** to determine if the brass components leached any materials into the water circulated and pressurized with the piston pump on the unit. Initial testing occurred with our existing, standard equipment that utilized a number of brass fittings and manifolds in both the bypass and spray pressure systems.

HYDRA-CRF

Dramm's new Corrosion Resistant Fittings (CRF) version of the Hydra eliminates the brass fittings replacing them with stainless or plated components. The pump still contains some brass components that are minorly wetted. The same testing procedure was employed as with the standard HYDRA sprayer using the new CRF version and found that no detectable levels of lead were present after recirculation with water and ZeroTol at a 1:50 ratio. The New HYDRA-CRF is available for use with corrosive oxidizer.

Dramm® Hydra™ SprayTrax®

Capitalizes on years of experience in chemical applicator design to make a powerful sprayer that is easy to use. Stainless inner sleeved, triplex piston pump coupled to a 5.5 HP Honda gasoline motor producing 7 gallons per minute. The SprayTrax offers enough volume to utilize a choice of guns or drenching equipment and agitate the tank simultaneously. The SprayTrax cart is designed for maximum maneuverability with tracking axles that both turn. The SprayTrax can turn 360 degrees within 7ft.



Gas Engine, Single Reel, 150ft Hose, 50gal
Tank
DRMHYDRAGST50150
Min Buy 1 EA



Dramm® MSO Heavy Duty Hydraulic Sprayer

Model MSO is a hydraulic sprayer with fully adjustable pressures, making it a highly flexible tool for the application of pesticides, fungicides, wetting agents, cleaning solutions and disinfectants. By simply twisting the spray gun knob you can adjust the pressure from a stream that throws up to 20 feet to an eight foot diameter mist. Pneumatic Turf tires are available on special order.



Electric Motor, 500psi, 1/4hp, .5gpm, 33ft
DRMMSO
Min Buy 1 EA

Electric Motor, 500psi, 1/4hp, .5gpm, 100ft
Discharge Hose, 20gal Tank,
DRMMS20100
UPC 049961977679
Min Buy 1 EA



DRAMM

Sprayers

Dramm® MSO Sprayer 33ft Package

Hydraulic sprayer with fully adjustable pressures, making it a highly flexible tool for the application of pesticides, fungicides, wetting agents, cleaning solutions and disinfectants. Includes: 33ft discharge hose, trigger gun, MSO Heavy Duty Sprayer and 20gal tank and cart.



DRMMS2033

Min Buy 1 EA



Dramm® MSO Heavy Duty Gas Sprayer

Model MSO is a hydraulic sprayer with fully adjustable pressures, making it a highly flexible tool for the application of pesticides, fungicides, wetting agents, cleaning solutions and disinfectants. By simply twisting the spray gun knob you can adjust the pressure from a stream that throws up to 20 feet to an eight foot diameter mist. Pneumatic Turf tires are available on special order.



Gas Two Cycle Engine, 350psi, 1/2hp,
1.8gpm, 66ft Discharge Hose, 20gal Tank

DRMMS20GAS66BF

Min Buy 1 EA



Dramm® Ferticart 3

Offers three separate seven gallon tanks, plumbed to allow easy switching between different solutions.



7gal

DRMFC3X7DT

Min Buy 1 EA



Dramm® Coldfogger™

The large tank holds enough spray solution to provide up to 70,000 sq ft of coverage in as little as 70 minutes. The powerful high pressure fog projects a plume of 30-60 micron diameter spray droplets 20 - 25ft from the hand held spray gun. The quality of spray is a tremendous improvement over conventional hydraulic sprayers that produce droplets that vary in size from 100 - 400 microns. Includes 150ft of High Pressure Hose.



3,000psi

DRMCFAR20150

Min Buy 1 EA



Dramm® Chemdose™

Portable solution for precise dosing of chemical solutions directly to the pot or root zone. Cart mounted with a 20gal tank, an 18 width and a rechargeable batter. Includes three different wand lengths.



20gal

DRMCD120

Min Buy 1 EA



Dramm® Large AutoFog™

Treats 30,000 sq ft. Treats 70,000 sq ft with additional fans. Fogger head separates from control and compressor carriage for portable use. 240 Volts 60HZ, single phase. Includes head and compressor.



220V

DRMLVH20ASS

Min Buy 1 EA

240V

DRMLVH20A

Min Buy 1 EA



Dramm® Mini AutoFog™

Treats up to 5,000 sq ft alone or up to 7,000 sq ft with HAF fans. Perfect for individual greenhouses, quonset huts and smaller areas. More than one can be used together for larger areas and separated for smaller areas.



120V

DRMMLVH10A

Min Buy 1 EA

120V

DRMMLVH10ASS

Min Buy 1 EA



Dramm® AutoFog™

Treats 12,000 sq ft. Treats 26,000 sq ft with additional fans. Fogger head separates from control and compressor carriage for portable use.



110V

DRMSLVH20A

Min Buy 1 EA

120V

DRMSLVH20ASS

Min Buy 1 EA



Similar to the Hydra the **AutoFogs** also offer a **Stainless Steel Package** for the application of **corrosive chemicals**.

Stainless Steel Nozzle for MLVH and SLVH Autofog

For the application of corrosive chemicals with the Autofog. Replaces the standard brass nozzle. Available for all Autofog sizes

DRAMM

Sprayers

Dramm® K-10 Portable PulsFOG®

Rapidly applies chemicals as a fog. The ultra-fine cloud of droplets penetrates deep into the plant canopy covering all surfaces, ensuring excellent control of greenhouse pests and diseases. For greenhouses. Fogs 10L in 45 minutes. Propels fog up to 65ft.



25hp / 10L
DRMK10
 Min Buy 1 EA



Dramm® K-22 Standard PulsFOG®

Rapidly applies chemicals as a fog. The ultra-fine cloud of droplets penetrates deep into the plant canopy covering all surfaces, ensuring excellent control of greenhouse pests and diseases. For greenhouses. Fogs 10L in 30 minutes. Propels fog up to 120ft.



50hp / 10L
DRMK22
 Min Buy 1 EA



Dramm® PulsFOG® Turbo Hybrid Coldfogger

The PulsFOG Turbo Hybrid is an electrically powered, pneumatic cold-fogger. Its high-performance turbine creates a powerful, warm flow of air that atomizes and propels the fog up to 75ft, depending on the nozzle and particle size. The output and droplet size of the Turbo Hybrid may be altered by changing the nozzle for a variety of applications and results. The Turbo Hybrid is perfect for the directed application of pesticides, fungicides and disinfectants, including corrosive chemicals. Because the unit is a cold fogger, the Turbo ULV is ideal for the application of bio-rational products. For best operation, the Turbo Hybrid requires the use of a carrier solution to help with particle atomization.



5L Capacity
DRMTULV110
 Min Buy 1 EA



Dramm® Chemdose™ 2

A portable, hose-end unit that connects to either an injector or hydraulic sprayer below 100 psi. This eliminates problems with hose length and power. Tank not included.



DRMCD2
 Min Buy 1 EA



Sprayers

Dramm® Back Pack Sprayer with Lithium Ion Battery

The Dramm BP-4 Back Pack Sprayer is a rechargeable, battery powered, high-pressure sprayer that fits comfortably on your back. Operating at a maximum of 150 psi, the BP-4 atomizes spray solutions for excellent coverage. The battery operated pump ensures even flow rates. The 4 gallon capacity is just the right size. Perfect for spot treatments or concentrated applications, but small enough to still be comfortable. Package includes a quick change battery and a quick charger. Operating time on one battery is 45 min.



150psi
DRMBP4LI
 Min Buy 1 EA



Dramm® Foaming Sprayer

Foam improves disinfection by increasing contact time. Air is pumped by hand into the chamber, pressurizing the spray solution. Some of that compressed air mixes with the spray solution in the nozzle to create an air-rich foam. The aerated foam slowly degrades over time, allowing for more contact time. The Foam 8L comes with three different mixing valves to allow for different air/solution ratios and different qualities of foam. Five liter tank will treat up to 500sq ft. Relief valve auto opens at 60PSI.



8lt Comression Foamer
DRMFOAM8L
 Min Buy 1 EA



Controllers

Dramm® ii ri Bluetooth Smart Irrigation Controller

Irrigation controller with Bluetooth connectivity, the ii ri Smart Controller can operate one solenoid valve without wiring. Use your smartphone to create watering schedules you can easily change according to your needs. CR123 battery operated, works with different valves.



DRMIIRISVB075
 Min Buy 1 EA

DRMIIRISVB100
 Min Buy 1 EA



Dramm Controller

The Dramm AME Variable Power-Station is designed to provide precise control in a variety of applications. The analog Power-Station can be used for controlling variable-speed single-phase fans, electrical heating, bulb or tube lights, cooling systems or other electrical devices.



PS20
DRMPS20
 Min Buy 1 EA

DRAMM

Controllers

Dramm® Single Stage Thermostat

The Dramm Microfan mechanical thermostats are designed with rough environments in mind. These high quality thermostats are perfect for any situation where harsh conditions may damage less durable equipment. Protected in sealed PVC housings, these thermostats offer stainless steel coiled sensors and accuracy to 1_ C. The SPDT (Single Pole Double Throw) switch contact (one set of contacts open on temperature rise as the other set closes) is a no load contact and offers superior accuracy.



DRMT41

Min Buy 1 EA



Dramm® Two Stage Thermostat

The Dramm Microfan mechanical thermostats are designed with rough environments in mind. These high quality thermostats are perfect for any situation where harsh conditions may damage less durable equipment. Protected in sealed PVC housings, these thermostats offer stainless steel coiled sensors and accuracy to 1_ C. The SPDT (Single Pole Double Throw) switch contact (one set of contacts open on temperature rise as the other set closes) is a no load contact and offers superior accuracy.



DRMT42

Min Buy 1 EA



Ventilation

Dramm® AME Horizontal Air Flow System

The Dramm AME Horizontal Air Flow (HAF) Fans offer efficiency, flexibility, and simplicity. Utilizing an aerodynamic design and a high-efficiency motor, the AME fan is equipped to maximize the air flow potential of any situation. When combined with speed controllers, the AME Fans offer unmatched flexibility in air flow as plants grow and mature. Because of their shrouded, aerodynamic design and high-efficiency motor, Air Movement Efficiency (AME) fans cover greater distances with better, more even air speeds. The AME Fan design provides leverage for air movement. The result is not only increased forward propulsion but a pull from behind the fan as well.



350mm

DRM350

Min Buy 1 EA

400mm

DRM400

Min Buy 1 EA



Propagation

PlantBest™ Heated Seed Starting Greenhouse Kit - 72 Cells

Designed for gardeners that wish to start plants early or don't have sufficient window light. Heating mat provides a more even distribution of heat and warmth to seedlings for enhanced germination. Kit includes: carrying tray, insulation base, greenhouse dome, 72 cell insert and a specially designed heating mat for faster controlled growth.



PPR3453

UPC 770932005809

Min Buy 6 EA



PlantBest™ Propagation Seedling Heat Mat

Place under a growing tray to create a warm environment for seedling growth. Speeds germination and encourages stronger root growth. Warms root zone 10 - 20 degrees above room temperature to increase success rates of seedlings, clones and cuttings. Durable, waterproof construction. Instructions and helpful hints for plant health printed on mat.



10in x 20in

PPR3462

UPC 770932001474

Min Buy 6 EA

20in x 20in

PPR3463

UPC 770932003218

Min Buy 16 EA

20in x 48in

PPR3464

UPC 770932003225

Min Buy 6 EA





Greenhouse Ventilation

Schaefer® Versa-Kool® H.A.F. Barrel Fan

Increase safety and productivity with Versa-Kool circulation fans. The patented guard design allows for greater air movement at very low noise levels. Improve air quality and working conditions by strategically placing Versa-Kool circulation fans using option available for wall or ceiling mounts. The airflow ranges from gentle to powerful and the fans have the variable speed capability which allows you to select a perfect airflow pattern.

- Available in 8in to 24in diameters
- Extremely rugged guards and housings for long life
- Guard spacing and engineered blades result in greater air movement at lower noise levels
- Depth of front guard makes fan extremely safe, but not OSHA compliant if mounted below seven feet.
- Guards are powder coated over steel for corrosion resistance.
- Heavy-duty totally enclosed, maintenance free North American motors.
- Two-year limited warranty.



12in Diam / 1.3/.65 Amps @
115/230 Volts 60hz

SVEVK12 Min. Buy 1ea



20in Diam / 3.8/1.9 Amps @
115/230 Volts 60hz

SVEVK20 Min. Buy 1ea

Schaefer® Versa-Kool® Deep Guard Circulation Fans HAF Barrel Fan

Reduce heat stress and improve air quality with Schaefer's uniquely designed circulation fans. Unrivaled in the market, these fans are engineered to produce greater air movement and superior cooling no matter the application. You don't hear them. You don't see them. You only feel them! Also known as Horizontal Air Flow (HAF) fans, these fans move air in a coherent horizontal pattern creating a gentle 'racetrack' air flow pattern needed in greenhouses to maximize heat distribution and humidity control by mixing the air, from ceiling to floor. Deep guard design for unmatched performance, low noise levels and safety without sacrificing airflow. Matched high quality motors and blades for maximum efficiency. Powder coated steel guards for increased durability and corrosion resistance. Powder coated steel mounting bracket and power cord included. Wide variety of mounting options available for flexible and easy installation. Two year warranty. Made in the USA.



8in Diam | 1550 Max RPM, <1000 CFM Range, 0.6 Nameplate Amps, 3
Wings, 1/100 Hp, 8lb, Single Speed, 60Hz, 115 Volts

SVEVK8
Min Buy 1 EA



Schaefer® Shade Pole Inflation Blower

Shaded pole inflation blowers have forward curved wheels and energy efficient, open drip proof motors. These blowers are frequently used for inflating air between two layers of greenhouse polyethylene to provide better insulation.

Large Inflation



148CFM - For Greenhouses Larger than 30x100
SVEB148 Min. Buy 1ea

Small Inflation



60CFM - For Greenhouses Less than 30x100
SVEB60 Min. Buy 1ea



148CFM - For Greenhouses Larger than 30x100
SVEB148-E Min. Buy 1ea



60CFM - For Greenhouses Less than 30x100
SVEB60-E Min. Buy 1ea





Greenhouse Ventilation

Schaefer® Aluminum Shutter

Allow airflow in a single direction and are used as building air inlets to feed exhaust fans, or on exhaust fans to prevent air entry when the fan is not operating. Aluminum shutters are built tough for long life in the most demanding environments, all at an affordable price. Constructed of heavy-duty brushed aluminum for corrosion resistance and greater durability. Interlocking louvers for maximum weather protection and lightweight for high efficiency and easy installation. Tie bar to eliminate shutter flapping.



60.5in W x 61in H

SVEWS-600

Min. Buy 1ea



Schaefer® Large Shutter Motor

For use with Schaefer shutters over 48 inch.



SVESHUTTERMOTOR-LG

Min. Buy 1ea



Schaefer® Fiberglass Exhaust Fans

Schaefer's narrow profile, fiberglass housing exhaust fans are designed to exhaust a lot of air for a long time. All fans ship fully assembled and have self-adjusting belt tensioners and heavy-duty aluminum shutters installed.

Features:

- Available in 36in, 48in and 52in sizes
- Heavy-duty, totally enclosed, maintenance free and energy efficient motors
- Long life pillow block bearings
- Large radius fiberglass venturi for maximum airflow, long life and good looks
- Galvanized or stainless blades for high performance and long life
- Efficient and reliable spring belt tensioning system
- Two-year limited warranty; 15-year housing warranty



Fiberglass Exhaust Fans

Schaefer® Direct-Drive Exhaust Fans Direct-Drive Shutter Style and Flush-Mount Exhaust Fans

Schaefer's high quality, long life, exhaust fans are a cost-effective way to exhaust air and moisture from most greenhouse facilities. Designed for low to medium volume exhaust airflow and suited for a broad range of facilities. Use PFM flush-mount exhaust fans for larger exhaust airflow requirements and to enable mounting the fan flush with the interior wall and exhausting through thicker walls.

Features:

- Available in 9in, 12in, 16in, 20in and 24in sizes
- Heavy-duty, totally enclosed, maintenance free and energy efficient motors
- PFM flush-mount style fans have polypropylene blades, rugged polyethylene housings and PVC or aluminum shutters for long life
- Two-year limited warranty; 25-year polyethylene housing warranty



Direct-drive flush-mount style variable speed* exhaust fan



Schaefer® Wet Wall Evaporative Cooling System

Ideal for cooling greenhouses, warehouses, and other large facilities. Schaefer's Wet Wall Evaporative Cooling Systems, in conjunction with Schaefer exhaust fans, provide up to 30°F of cooling for large volume buildings, from the evaporation of water from wet wall pads (evaporative media).

- Custom lengths and heights available.
- Up to 5-year pad life with proper pad maintenance.
- Choice of 1 Hp and ¾ Hp Gould™ pumps; 110V or 220V.
- Single- or multi-stage automatic controls available.
- Easy to install, operate and maintain.
- Water that does not evaporate is recycled through the pads; no wasted water.

Wet Wall Pads/ Evaporative Media

Used in Schaefer Wet Wall Cooling Systems and wet wall systems from other manufacturers, wet wall pads are fluted cellulose pads designed for maximum airflow, maximum evaporation, structural strength and long life.

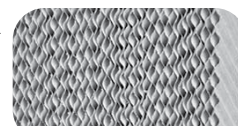

Schaefer® Galvanized Slantwall Exhaust Fan

First choice of growers and other building owners looking for very low cost, high volume exhaust fans that flush-mount from inside the building and shed water and snow, once installed. Designed for high airflow and high efficiency and available in many sizes and configurations to meet application requirements. Fans ship fully assembled with aluminum inlet shutters, self-adjusting belt tensioner (on belt-drive models) and galvanized outlet guard. Cord not included.



48in Diam / 8.4/4.2 Amps @ 115/230 Volts
60/50hz / Phase 1 / 5 Wings

SVE48551

Min. Buy 1ea



Schaefer® Eventherm® Single Phase Thermostat

Automatic controls to control fans and heaters and optimize thermal comfort.



4.5in W x 6 3/8in L x 3in H / 16 Amps @ 120/240
Volts 60/50hz / Phase 1

SVET335TH420

Min. Buy 1ea





SYMBOL OF QUALITY

ACME ENGINEERING & MANUFACTURING CORP

Ventilation

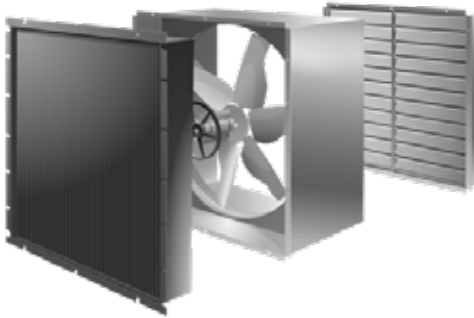

DCWB fan with light deprivation

The DCWBLT fan is designed with a light trap that fits into the housing to optimize the floor space in your greenhouse.



ACME Ventilation Motorized Shutter Motor & Spring

Shutter motor and spring for single and double panel shutter. Includes motor and spring.



Model #697470C

ACME697470C

Min Buy 1 EA



DELTA
SPRAYERS

Sprayers

Delta® Orbital Sprayer

Finally, a trigger sprayer that sprays in any position, including upside-down, sideways and upright. Adjust the pattern from fine mist to narrow stream. Industrial quality sprayer, made with recycled resin.



32oz

DLTFG32ORB112

UPC 042854032981

Min Buy 12 EA



Delta® Sprayer Plant Care Fine Mist Bottle

Delivers a better-than-aerosol spray quality that sets brands apart. It's a next generation, trigger-based, dispensing technology that eschews conventional propellant gases and pressurized containers. Its very fine mist combined with continuous spray functionality covers large areas quickly, evenly and in all directions from first to last drop. Superior ergonomics and 360° dispensing make it a delight to use. A standout feature is the low noise performance – a necessary requirement in some instances and a preferred feature for a wide range of applications.



10oz

DLTFG300MLFLORA112

UPC 042854300301

Min Buy 12 EA

24oz

DLTFG700MLFLORA112

UPC 042854700019

Min Buy 12 EA



Delta® Plant Care Pressure Sprayer

Continuous spraying after quick priming. Features a metal plunger rod and lever-loc for big spraying job convenience with a fully adjustable spray pattern. The bottle is made of specifically thick, virgin resin for strength and durability across a wide range of chemicals. Trigger sprayer is BPA free.



48oz

DLTFG48PC16

UPC 042854648700

Min Buy 6 EA



Delta® Spraymaster

The sprayer contains improved chemically resistant components, and we've added a padded end cap so that the sprayer rests even more comfortably in your hand. Delta's Spraymaster continues to offer high output performance in a powerful package of great design and heavy duty chemical resistant material construction.



32oz

DLTFG32SM112

UPC 042854932007

Min Buy 12 EA





Controllers

SmartBee Controllers™ 8 Channel 24V Dry Contact Controller

The SmartBee 24V Dry Contact Controller, allows you to step down your high-voltage relays to operate low-voltage appliances giving you a variety of use options that may be suitable to your established electrical configuration. The eight-relay dry contact controller is ideal for opening low-voltage solenoids serving multi-zoned irrigation systems within a single microclimate. The Hive communicates with the DCC8 over your network to turn relays ON or OFF and uses sensor data to compare conditions to set points, and turn the required electrical appliances ON or OFF controlling your appliances to your desired settings. A perfect solution for greenhouses, the SmartBee 24V Dry Contact Controller is great for actuating blackout appliances and louvers that aid light deprivation applications. If you're running different crop varieties in one room, a common practice is to irrigate in zones thus maximizing the efficiency of each of the crops individual feeding needs. The 24V Dry Contact Controller has the ability to utilize the SmartBee App's irrigation schedules in the same way you would normally schedule irrigations in the system. You may be currently plugging several solenoids onto a control device such as a Smart Strip 4 (SS4). Now you can wire those same zones into the 24V Dry Contact Controller and have the same control while freeing up some controllable outlets you currently use for irrigation.



SBT100136

UPC 013964989779

Min Buy 1 EA



SmartBee Controllers™ Environmental Base System

The SmartBee Controllers Environmental Base System is the perfect automation solution as you begin to build your Networked Garden™. Utilizing an industrial-grade wireless communication protocol, The Hive™ Gateway is your central hub for processing the incoming environmental data from your LTH Sensor, as well as the operating status of appliances plugged into your Stinger Smart Power Strip 4 or our new 24V Dry Contact Controller. With your existing WiFi signal, you can then monitor and control your garden, set up alerts for when conditions go outside their set points, and initiate corrective actions for optimal conditions...all this across multiple garden areas and all from your web-enabled smartphone, tablet, or computer! Grow your success! As your easy to set-up SmartBee Controllers Environmental Base System helps deliver greater and more consistent yields, scale up with add-on sensors and controllers including additional LTH, LTH PRO & LTH+CO2 sensors, our Water Content Sensors, and any of our programmable Smart Power Plugs. The SmartBee Controllers Environmental Base System provides a complete solution for all of your lighting, irrigation, and environmental systems, for total control of your garden's needs. Made for growers by growers, SmartBee Controllers delivers knowledge and efficiency, with ease and simplicity in mind.



DCC8

SBT10011002

Min Buy 1 EA

SS4

SBT10011001

UPC 091037952202

Min Buy 1 EA

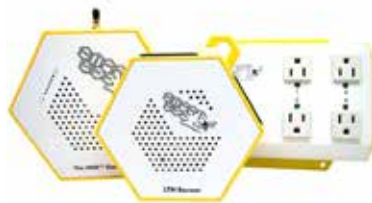

SmartBee Controllers™ Environmental Premier System

The SmartBee Controllers Environmental Premier System is the perfect automation solution as you begin to build your Networked Garden™. Utilizing an industrial-grade wireless communication protocol, The Hive™ Gateway is your central hub for processing the incoming environmental data from your LTH Pro Sensor, as well as the operating status of appliances plugged into your Stinger Smart Power Strip 4 or our new 24V Dry Contact Controller. With your existing WiFi signal, you can then monitor and control your garden, set up alerts for when conditions go outside their set points, and initiate corrective actions for optimal conditions...all this across multiple garden areas and all from your web-enabled smartphone, tablet, or computer! Grow your success! As your easy to set-up SmartBee Controllers Environmental Premier System helps deliver greater and more consistent yields, scale up with add-on sensors and controllers including additional LTH & LTH PRO sensors, our Water Content Sensors, and any of our programmable Stinger Smart Power Plugs. The SmartBee Controllers Environmental Premier System provides a complete solution for all of your lighting, irrigation, and environmental systems, for total control of your garden's needs. Made for growers by growers, SmartBee Controllers delivers knowledge and efficiency, with ease and simplicity in mind.



DCC8

SBT10010902

Min Buy 1 EA

SS4

SBT10010901

UPC 091037952196

Min Buy 1 EA



SmartBee Controllers™ Extension Cable for WCS Probe

Water Content Sensor Probe 10 Foot extension cable.



10ft

SBT100114

Min Buy 1 EA





Controllers

Smartbee Controllers™ Irrigation Base System

Introducing a complete system for wirelessly managing and maintaining your garden's healthy root zone with the SmartBee Controllers Irrigation Base System. The Hive™ Gateway is your main logic controller integrating our Water Content Sensor and additional five-pack of probes to monitor water content and root zone temperature, as well as the Stinger Smart Power Strip 4 or our new 24V Dry Contact Controller, which ties in irrigation pumps for a complete watering system. With your internet connection, you have complete command and control through your web-enabled wireless device of exactly how and when to water your garden, thus increasing efficiency and maximizing yields!*



DCC8

SBT10011902

Min Buy 1 EA

SS4

SBT10011901

UPC 091037952288

Min Buy 1 EA



Smartbee Controllers™ LTH Pro Sensor

The LTH Pro Sensor provides monitoring and control for light, temperature, humidity, VPD, and CO2 with the added feature of a PAR sensor input. The LTH Pro can also provide readings for PAR, PPFD (Photosynthetic Photon Flux Density) and DLI (Daily Light Integral) when paired with the Apogee Par Sensor (sold separately). Apogee Instruments Quantum Sensors provide accurate and cost-effective measurement of photosynthetically active radiation (PAR) from all light sources used to grow plants.



SBT100102A

UPC 013964989724

Min Buy 1 EA



Smartbee Controllers™ LTH Sensor

The SmartBee LTH sensor is designed for constant monitoring of your Light, Temperature, and Humidity levels. As the main drivers of plant growth, efficient and consistent monitoring and control of these factors are crucial to the quality of your garden. Ensuring your garden is operating within ideal conditions is why SmartBee Controllers created a modular system of scalable sensors and control software that give remote access and allow threshold adjustments 24/7, or what we call the SmartBee advantage.



SBT100101

UPC 091037952110

Min Buy 1 EA



Smartbee Controllers™ Range Extender Through Wall Kit

Extend the use of your Range Extender, through a wall... This kit includes everything you need: 1 - Power Divider/Combiner 2 - Extension Cables (2.4GHz) 1 - Antenna Brackets and mounting hardware included.



SBT100135

Min Buy 1 EA



Smartbee Controllers™ Range Extender With Splitter

External antenna with cable for use with new Range Extender



SBT100001

UPC 013964989717

Min Buy 1 EA



Smartbee Controllers™ RootGuard

The SmartBee RootGuard is used to keep the opening in medium clear and to protect the root system of the plant. This allows the grower to maintain the same insertion point for the SmartBee Handheld Water Content Meter Probe and consistent readings.



5pk

SBT100113

UPC 091037952226

Min Buy 1 EA



Smartbee Controllers™ Stinger Contractor

Use with either SS1 or SS4 for 120VAC equipment that requires high startup current



SBT100141

Min Buy 1 EA

Smartbee Controllers™ The Hive Gateway

The Hive Gateway manages the incoming sensor data within your network, serving as the main logic controller that integrates all your grow room's systems. Incoming data from the SmartBee wireless sensors is logged and processed through our custom rules engine for optimum control across all of the systems within your garden, and takes the guess work out of what your plants need to thrive. Purchasing The Hive™ Gateway as a stand alone product is not recommended. Therefore we recommend purchasing our Base and Premier systems which include an LTH or LTH Pro as well as our Stinger Smart Power Strip 4.



SBT100100

UPC 091037952103

Min Buy 1 EA





Controllers

Smartbee Controllers™ Through Wall Kit

External antenna with cable for use with new Range Extender



SBT100002

UPC 013964989762

Min Buy 1 EA

Smartbee Controllers™ Water Content Probe

Take advantage of your Water Content Sensor's full capabilities by adding five more permanent placement probes for a bigger picture of temperature and volumetric water content within your medium. Multi-point monitoring is the key to delivering your plant's exact water needs and adding more probes to your SmartBee Water Content Sensor will only increase efficiency. Log aggregate data from multiple test sites for optimum water content, temperature readings, and safeguard your root zone from pests and pathogens for a more finely-tuned garden.



5pk

SBT100111

UPC 091037952295

Min Buy 1 EA



Smartbee Controllers™ Water Content Sensor

Our SmartBee Water Content Sensor has been specifically designed to deliver the benefits of timed feedings by monitoring the volumetric water content of your medium. Through multi-point monitoring, knowing how much water your plants use is the key to delivering their exact water needs. The SmartBee Water Content Sensor allows you to log and aggregate data from multiple test sites for analysis, creates more decisive plant management based on dry-down times and root zone temperature, and with that maximizes the efficiency of your irrigation system.



SBT100103

UPC 091037952134

Min Buy 1 EA

SBT100132

UPC 013964989748

Min Buy 1 EA



Smartbee Controllers™ USB to 2.5mm x 5.0mm



58in

SBT62004401

Min Buy 1 EA

Smartbee Controllers™ Ultimate Starter System

The SmartBee Controllers Ultimate Starter System is the best way for you to begin to build your Networked Garden™. The system provides a complete solution for all your environmental, irrigation, and lighting needs, allowing you to monitor and control your grow with ease and simplicity in mind. Utilizing an industrial-grade wireless communication protocol, The Hive™ Gateway is your central hub for processing the incoming environmental data and monitoring the operating status of your LTH PRO and Water Content Sensor. Your LTH PRO sensor captures light, temperature, humidity and CO2 data while your Water Content Sensor and Probes monitor water content and root zone temperature. When combined with a Stinger Smart Power Strip 4 or our new 24V Dry Contact Controller, you can control your water pumps to optimize your grow room irrigation. With your existing WiFi signal, you can set up alerts for when conditions go outside their set points, and initiate corrective actions for optimal conditions... all this across multiple garden areas and all from your web-enabled smartphone, tablet, or computer!



DCC8

SBT10013402

Min Buy 1 EA

SS4

SBT10013401

UPC 013964989755

Min Buy 1 EA



Smartbee Controllers™ Water Content Sensor Probe

Take advantage of your Water Content Sensor Module's full capabilities by adding more permanent placement probes for a bigger picture of temperature and volumetric water content within your medium. Multi-point monitoring is the key to delivering your plant's exact water needs and adding more probes to your SmartBee Water Content Sensor Module will only increase efficiency. Log aggregate data from multiple test sites for optimum water content, temperature readings, and safeguard your root zone from pests and pathogens for a more finely-tuned garden.



SBT100104

UPC 091037952141

Min Buy 1 EA



Smartbee Controllers™ USB 2.0 Type A Male to Mini B



72in

SBT620022

Min Buy 1 EA

Smartbee Controllers™ USB Power Brick 5V 2A



SBT730005

Min Buy 1 EA



Controllers

Smartbee Controllers™ Stinger Smart Power Strip 1 20A

Stinger Smart Power Strip 1 allows you to plug third-party devices that require 20 amps activating humidifiers, irrigation pumps, or other grow room appliances. The Stinger Smart Power Strip 1 monitors real-time power consumption and extends the range of your wireless sensor network, while active digital circuit breaker technology ensures devices are consistently working and notifying you when they aren't. Remotely set thresholds and the Hive™ gateway will activate appliances as needed to keep your garden's systems operating at peak performance.



SBT100139

UPC 091037952158

Min Buy 1 EA



Smartbee Controllers™ Stinger Smart Power Strip 4

Stinger Smart Power Strip 4 allows you to plug third-party devices into its four independently controlled and monitored outlets, wirelessly activating humidifiers, irrigation pumps, or other grow room appliances up to 15 total amps. The Stinger Smart Power Strip 4 monitors real-time power consumption and extends the range of your wireless sensor network, while active digital circuit breaker technology ensures devices are consistently working and notifying you when they aren't. Remotely set thresholds and the Hive™ gateway will activate appliances as needed to keep your garden's systems operating at peak performance.



SBT100140

UPC 091037952165

Min Buy 1 EA



Conservation Systems

FOGCO Systems

FOGCO products are becoming standard equipment for all greenhouse applications. FOGCO has become an industry leader in humidification, cooling, by developing innovative products to meet environmental needs.

Fog systems are proven to positively impact growing operations by regulating the temperature, humidity, and moisture content within the greenhouse. Fog systems are ideal for addressing and correcting the problems associated with high temperatures and/or low humidity levels. This promotes increased health and productivity within the greenhouse by eliminating "plant water stress, one of the most significant factors in the growth of all plants. Plants lose their moisture through evaporation from the leaves. They also gather carbon needed for growth in the form of carbon dioxide through the leaves. By controlling the plants' pores through the use of a properly designed fog system, the results are stronger and healthier plants with optimum growth potential. Fog systems can also be used to introduce fertilizers by injecting nutrients directly into the atmosphere. The moisture and the nutrients are absorbed by the leaves of the plant. Fogco also provides odor mitigation systems for operations regulated by odor compliance.

Features:

- Revolution Fan system provides 360 degree fog distribution.
- Ensures proper humidity levels
- Reduces demand for moisture
- Maintains favorable conditions
- Creates in-house propagation stock
- Reduces need for shading/whitewashing
- Reduces irrigation/water consumption



Contact your BFG Sales Rep

for pricing and customized solutions
for your operation.



Controllers

Bartlett Instrument Natural Ventilation Controller

Easy, affordable, touchscreen model featuring DIF, DAY and NITE stages for better crop management. Two heat and time proportional outputs. Proportional outputs open and close in five steps with manual override. Can control one or two separate zones. Optional remote app control with Headgrower.



BARTIRWL11X2
Min Buy 1 EA



Bartlett Instrument Temperature Control

Low-cost touchscreen greenhouse temperature control that is easy to operate, install and manage. Optional remote app control with Headgrower. Provides energy cost savings and data graphs. Features include: two zone controllers; DIF, DAY and NITE settings; four cool and two HAF relay outputs; two heat outputs, automatic or manual settings; timer and alarm output and vent stage for dehumidification.



BARTIGHK12X2
Min Buy 1 EA



PPE

BioMat Boot Sanitation Pad

A durable foot pad that controls plant pathogens at entryways. When used with BioSafe Systems' sanitizing solutions, like SaniDate® 5.0. One BioMat holds 2.5 gallons of disinfecting solution to clean the soles of shoes/boots, keeping contamination out of your facility.



BSFN09574
Min Buy 1 EA



Propagation

Bond® Reusable Garden "T" Marker

White plastic markers used to identifying house plants, flowers and vegetatables. Durable and easy to write on.



10pk
BON1182
UPC 034613011825
Min Buy 144 EA



BioTherm®

Elements...Enhanced.

BioTherm Climate Technologies - Air

BioTherm has proven systems designed to optimize the air inside your facility and ENHANCE your growing conditions so that even crops not normally grown in your region can flourish. They can take the temperature and humidity down just a touch, or they can close down the access to outside air and bring those factors way down. It is all in the design, and BioTherm's experienced team knows how to engineer and deliver systems made specifically for RUGGED cultivation environments using special air handlers or standalone dehumidifiers made of stainless steel.

COMPLETE CLIMATE ENHANCEMENT BY BIOTHERM

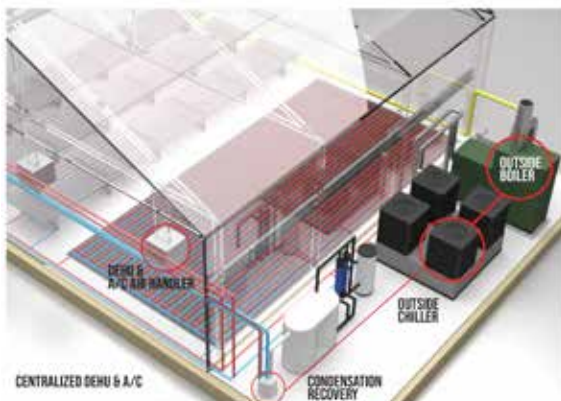

TOOB™ Dissolved Oxygen Infuser
The BioTherm TOOB™ is a revolutionary, efficient method of increasing the dissolved oxygen (DO) content of irrigation water, significantly improving plant health and productivity. Available in 2' and 4' sizes to address varying GPM rates..



Roll'N Grow™
Roll'N Grow™ is the perfect way to apply Root Zone Heating (RZH) to growing beds or benches! Like a carpet, your growing surfaces can now be covered with growth-enhancing gentle heat in a fraction of the time it used to take..



Fin Pipe – DuoFin™ & StarFin™
BioTherm DuoFin™ is the lowest heat output finned pipe, commonly used for under bench, perimeter, and in-crop heating. BioTherm StarFin™ is a high heat output finned pipe commonly used for bench, perimeter, top, and gutter heating.



Air Conditioning
BioTherm has a variety of greenhouse cooling technologies. Once chilled, water can be distributed with many space-saving options, including custom air handling units and the BioTherm Fin Pipe collection.



CO2 Enrichment
To help your plants grow and thrive, increasing CO2 levels within your greenhouse or indoor environment is essential. BioTherm's innovative systems utilize condensing boilers to achieve elevated CO2 levels and even distribution throughout your space.

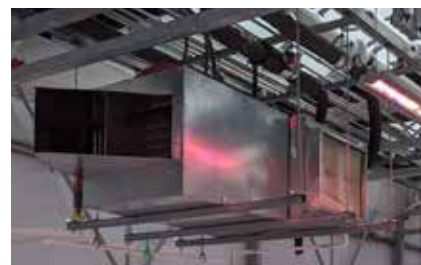

Dehumidification
BioTherm's lineup of high performance, energy-efficient, free-standing dehumidifiers are designed to control damaging moisture and humidity in industrial buildings and greenhouses. Sizes range from 1-ton to 25-ton units.

Raypak®

A Rheem® Company

XVERS™

FIRE-TUBE BOILER

FEATURING OUR NEW

HO₂T™

O₂ TRIM SYSTEM

The HO₂T O₂ Trim System available in the XVers boiler works by continuously monitoring and self adjusting to maintain optimal performance.

It features built-in automatic system protection that extends the life of your XVers by maintaining the optimum fuel to air ratio.

BioTherm

Contact us for all of your heating needs.
1-800-GET-HEAT
www.biothermsolutions.com



ENGINEERED TO PERFORM

BUILT TO LAST



Adaptable controls to support easy set up.



Maximum efficiency with maximum venting options.



Easy to move. Easy to fit. Easy to get it right.



Learn more at Biothermsolutions.com

BioTherm is the exclusive Raypak provider to the horticulture industry



Sprayers

Chapin® Specialty Mosquito Sprayer

Designed to create a fine fogging mist. The lightweight, 1-gallon poly tank has an ergonomic handle, funnel-mouth opening, poly shut-off with lock-on feature for continuous spraying, a fogging nozzle, SureSpray anti-clog filter and reinforced hose.



1gal Capacity

CHM2014

UPC 023883020149

Min Buy 1 EA



Chapin® Multi Purpose Hand Sprayer

Hand sprayer for herbicides, pesticides, fertilizers and general cleaning. Nitrile seals. Adjustable plastic cone nozzle. SureSpray Anti-clog filter. Polyethylene tanks which are non-corrosive, yet lightweight and durable.



48oz Capacity

CHM1002

UPC 023883010027

Min Buy 6 EA



Chapin® ProSeries Backpack Sprayer

Sprayer with deluxe features for the landscape and turf professional. Three stage filtration - strainer basket, filter in piston cylinder and filter in shut-off. 4in wide opening with strainer/filter basket. Padded shoulder straps to accommodate a full backpack comfortably for hours. Equipped with piston pumps and fluoropolymer elastomer seals in necessary key areas. Fluoropolymer elastomer is a brand of synthetic rubber and used in O-rings and other molded or extruded goods. Shut-off with padded cushion grip, built-in filter, fluoropolymer elastomer seals. Wand clips onto base rail to store the extension wand when not in use. 3pc nozzle pack includes a fan, cone and adjustable brass.



4gal Capacity

CHM61800

UPC 023883618001

Min Buy 1 EA



Chapin® SureSpray™ Lawn & Garden Sprayer

Multi-purpose sprayer for herbicides, pesticides, fertilizers and general cleaning. Features SureSpray anti-clog filter, translucent tank and a funnel top for easy filling. Poly ergo handle is designed for fatigue-free pumping. Polyethylene tank is non-corrosive to most fertilizers, herbicides and pesticides, yet is lightweight and durable. Cup included.



1gal Capacity

CHM20010

UPC 023883200107

Min Buy 1 EA





Did you know...?

BFG has a mobile app to make ordering easier!

Available for download on the app store and Google play



Propagation

DP Industries® Plastic T-Sign - Straight Top

Molded plastic T-Stakes provide signs for multiple use. Larger writing surface and reader friendly. To clean wipe with a wet paper towel or clean with alcohol based sanitizer.



White - Top: 3-1/4in W x 2-1/4in H with 13in H Leg / 100pk

DPITL13W

UPC 092291009305

Min Buy 1 CS



DP Industries® Economy Vinyl Wrap-Around Tag

Designed to easily wrap around tree or shrub branches. Best suited for use on larger plants and shrubs.



White - 5/8in W x 7in H / 1000 per Roll

DPITT758M

UPC 092291010400

Min Buy 1 RL



DP Industries® Thermal Transfer Vinyl Wrap-Around Tag

Thermal transfer printer compatible, vinyl material, best for use on larger plants and shrubs. Can be marked with garden pens.



White - 1in W x 9in H / 1000 per Roll

DPIWRAP91W

Min Buy 1 RL



Green.tek

Ventilation

Green-Tek® HAF Fan

Great performance, energy efficiency and an air pattern that is designed for heat de-stratification. The OSHA approved guard means the fan can be mounted at any height. Our totally enclosed air over motor can be used in the harshest greenhouse environments. GT HAF Fans are easy to install and will give years of trouble free service. The ideal spacing is every 50'. Comes with a 9ft cord.



20in, 1/10HP, with 9ft Cord

GRTKHAF20110C

Min Buy 1 EA



Green-Tek® High Performance HAF Fan

Great performance, energy efficiency and an air pattern that is designed for heat de-stratification. The OSHA approved guard means the fan can be mounted at any height. Our totally enclosed air over motor can be used in the harshest greenhouse environments. GT HAF Fans are easy to install and will give years of trouble free service. The ideal spacing is every 50'. Comes with a 9ft cord.



12in, with 9ft Cord

GRTKHVB12110C

Min Buy 1 EA



GrowerSelect®

Other

Grower Select® All-Purpose Transport Cart

The workhorse of the Grower Select cart line. The All-Purpose Transport Cart features all steel construction with a hot-dip galvanized finish, a welded wire base and three expanded metal mesh shelves. Connect multiple All-Purpose Transport Carts together using the heavy-duty drawbar and post system.



3 Shelves, 5in Rigid Casters, 59in L x 22in W x 82.5in H, 77lbs.

GSGS2259

UPC 049961203181

Min Buy 1 EA



Ground Cover

Grower Select® Deluxe Ground Cover

Premium 22 x 11 fine weave with tucked and woven edges. Resists tearing, puncturing and weed penetration. It is approved for most government weed control applications. Ideal for greenhouses, outdoor displays and as a weed barrier for plantings without topical coverings where a weed-free environment is a must. Striped every 12in to aid in plant alignment and is UV stabilized to last even in direct sunlight.



3ft x 300ft - 3.2oz

GSSBLT3300D

UPC 042579822645

Min Buy 1 RL

10ft x 300ft - 3.2oz

GSSBLT10300D

Min Buy 1 RL

4ft x 300ft - 3.2oz

GSSBLT4300D

UPC 042579822652

Min Buy 1 RL

12ft x 300ft - 3.2oz

GSSBLT12300D

UPC 042579822683

Min Buy 1 RL

6ft x 300ft - 3.2oz

GSSBLT6300D

Min Buy 1 RL

15.5ft x 300ft - 3.2oz

GSSBLT155300D

Min Buy 1 RL



Grower Select® Garden Staple - 8 Gauge

Used to secure polypropylene ground cover.



8in x 1in

WIREP29-0028B

Min Buy 1 BX

Heating & Cooling

Grower Select® Convection Tubing

4 mil UV-inhibited clear polyethylene tubing is engineered for uniform distribution and proper mixing of air to produce the best aerodynamic effect in the greenhouse. All of our convection tube is made from a UV stabilized greenhouse film.



18in x 1500ft

WA22-9080

Min Buy 1 RL

30in x 1500ft Unpunched

WA22-9090A

Min Buy 1 RL

24in x 1500ft Unpunched

WA22-9084A

Min Buy 1 RL



Tents

Gardman® 4 Tier Mini Greenhouse

Ideal for limited spaces. Shelving included. Also includes wall fixing rings and guy ropes.



2ft 3in L x 1ft 6in W x 5ft 3in H

WSPR687

UPC 745487006878

Min Buy 1 EA





Controllers

GrowFlux Dimmer

The GrowFlux Dimmer is constructed from tough, UV resistant ASA resin and sealed connectors, and stands up to impact, water, dirt, and sunlight.



0-10V Output 2 Channel
GROGFXDIM10VP1P2CNAR

UPC 860003018149

Min Buy 1 EA



GrowFlux Access Point

The GrowFlux Access Point is designed to work with a broad range of commercial and consumer Ethernet networks without special networking requirements.



Commercial Use Ip66

GROGFXAPCNA

UPC 860003018163

Min Buy 1 EA

North America

GROGFXAPNA

UPC 860003018101

Min Buy 1 EA



GrowFlux Cable

GrowFlux cables are IP67 rated and UV resistant for greenhouse use



2 Channel Bare Leads 0-10V

GROGFXDIM4CBL2M

UPC 860003018125

Min Buy 1 EA



Sealed Ip67 3 Meter Bare Leads

GROGFXATMDC2.53M

UPC 860003018156

Min Buy 1 EA



Sprayers

Hudson® Fog® Electric Atomizer Sprayer

Includes large commercial coiled hose for directing ULV chemical mist. Lightweight poly tank. Carrying strap. Operates on 110V AC power. Outputs 22-46 microns particle size - average droplet is 20 micron. Adjustable output of 1.5 to 14gal per hour. Shoots 13.5ft. For portable use.



2gal Capacity

HUD99598

UPC 690247995988

Min Buy 1 EA



Ventilation

J&D Mfg Destratification Fan

The JD360 is an effective destratification fan that mixes the heavy, cool, dense air that is sunk to ground level with the warm, light, thin air that lingers towards the top of your facility. This provides a comfortable and uniform healthy environment from the top of the peaks to the ground of your house. It's the perfect vertical, low-air-speed circulator and it's paired with J&D's impressive IP66 rated Gold Star Motor that is covered by a 3-year warranty. It's easy to install and maintenance free. Save money on your labor and your heating bill with the JD360. You'll like the price and the pallet quantity discount!



18in

JDMJD360

Min Buy 1 EA





H.E. Anderson
COMPANY
 2100 Anderson Drive P.O. Box 1006
 Muskogee, OK 74402-1006
 918-687-4426 FAX 918-682-3342

Fertilizer Injectors



J+ Advanced

H.E. Anderson J+Advanced Series Ratio:Feeder® Injection Systems

J+Advanced Ratio:Feeder® Injector Systems can inject almost any liquid chemical into a water line at a set ratio. Most common uses include fertilizer injection, acid injection for pH stabilization, chlorination, and sanitization.

All J+ Advanced Injectors can be configured to pump multiple chemicals or solutions at different ratios. Systems can be configured to work with flows ranging from 1/4 gallon per minute to 10,000 gallons per minute. Common injection rates range from 1:100 to 1:10,000. Injectors require at least 30 psi to operate with a maximum of 125psi or 100psi depending on which blend tank is utilized. Controllers can be powered using 120VAC or 12VDC.

J+Advanced injectors can be purchased as complete assembled units which fit most common applications or as individual components sized especially for your specific application.

- J+ Advanced CONTROLLER - Connects to the water meter and pilot valve/manifold. It measures the water flow using the water meter then turns the pilot valve on and off to stroke the pump heads at the proper rate to maintain the set ratio.

- WATER METER - Used by J controller to measure water flow. Many different models are available which can measure flows from 1/4 GPM up to 10,000 GPM.

- MANIFOLD/PILOT VALVE - Pump Heads are mounted to the manifold. The Pilot Valve, which is controlled by the J Controller, provides water pressure to the pump heads to make them pump.

- PUMP HEADS - Pump Heads are what actually pump the chemicals. Many different models and sizes are available to handle almost any liquid and feed ratio.

- BLEND TANK - Ensures the chemical injected into the water line is blended uniformly ensuring even distribution and allowing for accurate measurements to be made.

H.E. Anderson® J+Advanced Controller

Connects to the water meter and pilot valve/manifold. It measures the water flow using the water meter then turns the pilot valve on and off to stroke the pump heads at the proper rate to maintain the set ratio. Includes latest features, new backlit display and full keypad.



120VAC
HEAN15008

Min. Buy 1ea



DB Series

DB Wall Mount Series



DD Series

H.E. Anderson D Series Ratio:Feeder® Injector Systems

The DB & DD Series offer an inexpensive way inject almost any liquid into a water line at an adjustable ratio. Built with the same quality and pride as the J Plus, these pumps will inject one chemical up to a 1:100 ratio with models rated for 20 or 50 GPM. These models feature an adjustable feed ratio which makes fine tuning the injection ratio as easy as twisting a knob. Injectors can be turned down to 1/10th of their maximum feed ratio.

- Industry leading quality - legendary dependability helps save time on maintenance
- Easy installation and operation
- Positive Displacement - extremely accurate injection helps save money on chemicals
- Diaphragm Operation - No sliding seals, accuracy does not degrade over time
- Volume proportioning - constant chemical levels regardless of flow rates
- Adjustable feed rate - change the feed rate while unit is operating and without recalibrating
- Filter not required
- Extremely low pressure loss
- Low power consumption
- On/Off and Pulse Button

BFG Item#	Model	Water Flow Range	Maximum Feed Rate	Typical Use
HEANDB100	DB100	1/4 to 20 GPM	1:100 or 1%	Fertilizer
HEANDB1000	DB1000	1/4 to 20 GPM	1:1000 or 0.1%	pH Adjustment/Sanitizer
HEANDB100W	DB100W	1/4 to 20 GPM	1:100	Fertilizer
HEANDB1000W	DB1000W	1/4 to 20 GPM	1:1000	pH Adjustment/Sanitizer
HEANDD100	DD100	3/4 to 50 GPM	1:100	Fertilizer
HEANDD1000	DD1000	3/4 to 50 GPM	1:1000	pH Adjustment/Sanitizer



H.E. Anderson
COMPANY
 2100 Anderson Drive P.O. Box 1006
 Muskogee, OK 74402-1006
 918-687-4426 FAX 918-682-3342

Other

H.E. Anderson® J+Advanced Controller

Connects to the water meter and pilot valve/manifold. It measures the water flow using the water meter then turns the pilot valve on and off to stroke the pump heads at the proper rate to maintain the set ratio. Includes latest features, new backlit display and full keypad.



120VAC
HEAN15008
 Min Buy 1 EA

H.E. Anderson® A3 Teflon® Diaphragm Kit

A3 Pumper Diaphragm Kit Includes: 1 ea 16510 A3 CS w/ Teflon Diaphragm, 1 ea 18036 A3 WS Diaphragm, and a spare parts kit.



Diaphragm Kit A3 Teflon
HEAN17032
 Min Buy 1 EA

H.E. Anderson® Diaphragm Kit #4 Standard

Diaphragm kit #4



HEAN8939
 Min Buy 1 EA

H.E. Anderson® Diaphragm A3/T4 CS With Teflon Face

Diaphragm A3/T4 with teflon face.



HEAN16510
 Min Buy 1 EA

H.E. Anderson® Hosebarb With O-Ring

Hosebarb with o-ring



.5in
HEAN11741
 Min Buy 1 EA

H.E. Anderson® Kit For IPF

Kit for IPF



.5in
HEAN5404
 Min Buy 1 EA

H.E. Anderson® P2, H2 Standard Diaphragm Kit

Pumper Diaphragm Kit Includes: 1 ea 01066 #2 CS Diaphragm, 1 ea 01058 WS Diaphragm, and a spare parts kit.



Diaphragm Kit #2
HEAN8913
 Min Buy 1 EA

H.E. Anderson® Seal Kit Soft

Seal kit



For Type A
HEAN19043
 Min Buy 1 EA

H.E. Anderson® Type AS Pilot Valve Repair Kit

Pilot valve Repair Kit for 1/2in Type AS Pilot Valve.



1/2in, Type AS
HEAN19065
 Min Buy 1 EA

H.E. Anderson® Injector Tubing

Acid and Sanitizer Injector black poly tubing.



3/8 OD 1/4 ID, Sold by the ft
HEAN6892
 Min Buy 1 FT

H.E. Anderson® IPF Universal Assembly

IPF universal assembly



.5in
HEAN4094
 Min Buy 1 EA



Sprayers

Jacto Battery Backpack Sprayer

The Jacto PJB16 is the most innovative sprayer in its class. It features a long-life lithium-ion battery, digital display with soft touch buttons, 5 pressure settings, pace meter, battery level indicator, onboard diagnostics, auto shut off and lockable pressure setting. The Jacto PJB16 allows the user to select 5 different pressure settings. This makes the PJB16 sprayer capable of spraying herbicides, using low pressures to reduce drift and insecticides and fungicides normally applied with higher pressures for finer droplets and improved coverage. The PJB16 diaphragm pump produces 0.61gpm which is almost 60% higher than that of the competitors. The pump is protected by a suction filter to reduce the possibility of pump damage and clogging caused by impurities in the solution. The pump uses an internal pump micro pressure switch that turns the pump on when a pressure drop is seen and turns the pump off when the spray is stopped. The Jacto PJ16 sprayer is the only battery-powered sprayer that uses a Venturi, in tank, agitator to keep the chemical in solution. Ideal for use with whettable powders and other agrichemicals. The agitator lever is easily accessed even with the sprayer on your back.



4gal

JAC1272393

UPC 790943694268

Min Buy 1 EA



Jacto Backpack Sprayer HD-400

The 4-gallon (16-liter) HD400 has an internal mechanical agitator that does an excellent job of keeping powdered chemicals such as kaolin clay organic insecticides in suspension, as well as liquid chemical additives. The HD400 was independently tested for more than 1,500 continuous hours of operation with no breakdowns and the Jacto HD400 is easily converted for either right-hand or left-hand operation. Plus it only takes 6 handle pumps to achieve 45 psi, reducing operator fatigue.



4gal - Blue

JAC1210802

UPC 789666087521

Min Buy 1 EA

4gal - White

JAC1210803

UPC 789666087510

Min Buy 1 EA



Jacto PJB-8C Backpack Sprayer

The PJB combines technology with ease of use, in a comfortable lightweight design and will be the battery backpack sprayer of choice for herbicide applications. The 4 gallon PJB-16 is perfect for day to day use by everyone from the busy farmer or rancher, to the landscaper and market gardener or a homeowner with a larger acreage. The PJB-8C is the 2 gallon little brother and designed as a shoulder carry and is perfect for around the home use and garden.



2gal

JAC1230663

UPC 789666081193

Min Buy 1 EA



Other

Johnson Controller with Photo Sensor & Plug



JOHN-SA-01-00213

Min Buy 1 EA



Johnson Natural Gas CO2 Generator

A Johnson CO2 Generator automatically provides ideal carbon dioxide level when plants need it most, year round to maximize plant growth-efficiently & economically.



JOHN-EA-04-00001

Min Buy 1 EA



Johnson Transformer

Handles Up To 3 CO2 Units



120V/24V - 40VA

JOHN-05-05-00003

Min Buy 1 EA



Johnson Propane CO2 Generator

A Johnson CO2 Generator automatically provides ideal carbon dioxide level when plants need it most, year round to maximize plant growth-efficiently & economically.



JOHN-EA-04-00002

Min Buy 1 EA



Other Equipment



B-Line Flat and Pot Filler (Model 5343)

The B-Line is the most popular Kase Flat Filler, supporting the container sizes used by most greenhouses and nurseries. It is ideal for peat moss-based soils, is easy to operate, quiet and easily maintained.

With its generous 1.5-yard hopper, the B-Line offers a production rate up to 1,200 flats per hour, and it handles containers up to 18in wide x 12in tall. Feed your B-Line with a Kase 3561 Gobbler or 3538 Small Bale Buster.

Additional Filler Models include the high production N-Line, large capacity Super-B, and Minor-B for plug trays and smaller containers.



Gobbler (Model 3561)

The Gobbler is designed to process large 135 cu. ft. compressed bales (as well as smaller bales) into a fluffed and moistened potting soil, with a production rate up to 75 cubic yards per hour. The hydraulic lift gate platform is easily loaded via forklift or pallet jack. Basic start/stop controls or automated sensors allow the Gobbler to integrate with other processing equipment, such as a Kase Filler or 4300 Series Soil Conveyor. The Optional TopHopper dispenses an amendment of your choice directly into soil as it is processed through the Gobbler.



Modular Belt Conveyors (4100 Series)

If you are looking for versatility and portability without sacrificing durability, the Kase Modular Conveyor's simple design allows these conveyors to be easily networked to cover extended distances without sacrificing power. Conveyors are available with 10" and 15" wide belts and variable speed or reversing controls. Optional adjustable height stands are available to suit your production line.

Soil Mixers (3400 Series)

Kase offers four sizes of Batch Mixers to meet your needs for rapid, complete and uniform soil mixing. The 3/4 yard unit has a center discharge, while all other Kase Mixers have an end discharge. Each Mixer includes a spray apparatus for moistening soil and a safety grate with splash guard shielding the top of the unit. The 2 and 4 yard models incorporate a bolted replaceable bottom barrel, available in heavy duty abrasive resistant material.



Kase Water Tunnel

Watering Tunnels are used to water plant material that is planted in flats, pots, hanging baskets or other containers. Watering tables have smaller Drip Nozzles placed over the conveying unit to moisten plug trays. Watering Tunnels have water Spray Nozzles. They are self-contained using an open mesh Polyethylene conveying belt to move the product thru the machine at a variable speed rate, which is selected by the operator. The adjustable speed feature will help control the amount of water that is dispensed on your plant material. Different size nozzles are available also to control the amount of water flow. These units have water drip pans to catch all of the excess water into a drain at one end of the unit, which may be plumbed into an existing drain. The collection pans are longer than the spray area to catch the excess spray and have a area to place the plant material on the unit and an area to take the plant material away. Features: Stainless steel enclosure, Quad spray heads variety of nozzle size available, High impact poly chain and sprockets, Electric operated solenoid valve, Brass Ball Valve, Stainless slide racks Optional electronic control of water spray Variable drive speed Water Volume: 4gpm to 16gpm Belt Width: 12in, Maximum Flat Width: 16, Adjustable Height of Conveyor: 24in to 36in.



KASE2211 Min. Buy 1ea

Kase Horticulture

Other Equipment

Kase Production Lines

With over thirty years of experience designing and manufacturing Horticulture equipment, Kase provides custom solutions like the large pot Filling Lines and Mix Line shown below. Visit kaseworks.com to see the full line of Kase Horticulture equipment.





Contact your BFG Sales Rep
for pricing and customized solutions
for your operation.

Watering Booms and Systems



Single Rail Boom

Cherry Creek's Single Rail Boom is a cost-effective automatic system, designed with simplicity and efficiency in mind and ideally suited for smaller bays with simple watering requirements. Its rugged, compact housing is built to move up and down a greenhouse on one rail. It's spray bar is turned on or off by a single solenoid, and the boom waters the full width of the bay.

Double Rail Boom

Cherry Creek's Double Rail Boom offers the versatility of independent watering of the right, left, or both sides of the greenhouse, along with walk-through for walkways. With the stability of two running rails, boom sway is eliminated. Combined with the New TIC, the Double Rail Boom handles the most complicated application requirements, assuring precise rates of water and chemicals. Save significantly on both water and labor costs. Booms are nearly fully assembled and simple to install.

Walking (Navigator) / Tower Booms

Cherry Creek's Tower Boom is designed to be a workhorse for all of your irrigation, maintenance and crop inspection needs. It is almost completely pre-assembled at the factory, and is supported by rails mounted off the gutter posts on both sides of the bay that span the width of the greenhouse.

- Rugged construction
- Precise application of water and chemicals
- Water savings and reduction in labor
- Adaptable for conveyors and scaffolding
- Pre-assembled for easy installation
- Transportation system for equipment & humans.

ECHO Hanging Basket System – Water By Weight

The ECHO System allows for accurate measurements of water to each basket. Additionally, fertilizer applications can be consistently controlled, resulting in faster production times, higher yields, and more crop turns per season.

The NEW WBW (Water By Weight) Controller has the following features:

- 10" Touch Screen with Wifi capability for cell phones & iPads
- Water By Time Mode / Water By Weight Mode, 7 Day Schedule with Repeat Cycle every "X" hrs., 16 Schedules.
- WBW mode has a dry weight and wet weight setting for optimal root growth.

NEW TIC (Touch Irrigation Controller)

Boom automation allows for controlled application rates of water and chemicals, which reduces overspray and results in long-term savings. Automatic irrigation will also significantly reduce labor costs.

The new TIC is available on the Double Rail Booms, Walking (Navigator) Booms and Tower Booms. The TIC has the following enhancements:

- 16 Crops with their own 8 Areas that can Water, Mist and/or SSW all within the same Crop, 4 Schedules with 7 days of the week options. (ssw = step, stop, water).
- Auto Mode / Manual Mode with Queue position over-ride
- Touch Screen with Grower Friendly Menus
- Wifi capability for cell phone/iPad & remote access.

The gentle movement of the plants as they go through the watering mode allows them to experience various lighting exposures and air movement over the surface, which promotes healthier growth. The ECHO leaves the factory fully assembled, making installation fast and simple.

Touch Irrigation Controller TIC



Water By Weight Controller (WBW)





Other

Luster Leaf® Rapiclip® Plastic "T" Label

Label plants with these easy to use "T" Labels.



6.25in - 10pk

LUS820

UPC 035307008206

Min Buy 12 EA

13in - 5pk

LUS817

UPC 035307008176

Min Buy 12 EA



Luster Leaf® Rapiclip® Plastic Plant Labels

Label your plants with these easy to use white plastic labels.



6in - 50pk

LUS840

UPC 035307008404

Min Buy 12 EA

4in - 50pk

LUS827

UPC 035307008275

Min Buy 12 EA



Tents

Megaphoton Grow Tent

Creates the best possible growing environment for your plants. Maximises the quality and yield of your harvest. Helps closely control the growing environment. Light proof, durable, strong, safe.



3ft W x 3ft L x 6ft H

MEGPGGT002

UPC 069741632600

Min Buy 1 EA

4ft W x 4ft L x 6ft H

MEGPGGT003

UPC 069741632600

Min Buy 1 EA

5ft W x 5ft L x 6.5ft H

MEGPGGT004

UPC 069741632600

Min Buy 1 EA

8ft W x 4ft L x 6.5ft H

MEGPGGT005

UPC 069741632600

Min Buy 1 EA

8ft W x 8ft L x 6.5ft H

MEGPGGT006

UPC 069741632600

Min Buy 1 EA



Controllers

Megaphoton MPH Master Controller

Suitable for all kinds of Megaphoton fixtures with controller ports. Auto-dim at set temperature and auto-shutdown at set temperature, with a sunrise and sunset period. Controller is protected against short-circuits, and as no need for a switchboard.



50-100pcs

MEGLZTKZQ01

Min Buy 1 EA



Other

Megaphoton Rope Ratchets



Black - 8ft

MEGDJS01

Min Buy 1 EA





Heating & Cooling

Modine High Efficiency Gas Heater

At 93-97% thermal efficiency for all model sizes, Modine's Effinity93® condensing unit heater features the highest efficiency available in North America for commercial and industrial, as well as residentially certified (sizes 110 and smaller) gas-fired unit heaters. This industry leading efficiency is a result of the coupling of our Conservicore® secondary heat exchanger technology with our robust tubular primary heat exchanger design. The Conservicore® technology features a secondary recuperative heat exchanger fabricated from AL29-4C® stainless steel. Designed with aluminized steel heat exchanger/burner, direct spark ignition, 115V/60Hz/1 phase power and natural gas, single stage.



260,000 Btu/hr Input - Natural Gas
MODINPTC260AS-0111
Min Buy 1 EA

260,000 Btu/hr Input - Natural Gas
MODINPTC260SS-0111
Min Buy 1 EA

310,000 Btu/hr Input
MODINPTC310AS-0111
Min Buy 1 EA

310,000 Btu/hr Input - Propane Gas
MODINPTC310AS-0121
Min Buy 1 EA



Modine LP Heater

This power vented propeller heater is inexpensive to install, easy to use and offers excellent in-service economy. Features include: thermal efficiency of 83%, power exhaust that can be rotated 180 degrees, 100% shut-off, intermittent pilot-ignition system with continuous retry and a safety pressure switch to assure safe venting conditions. Designed with aluminized steel heat exchanger/burner, 115V/60Hz/1 phase power and 115V/24V IPI, 1 stg, propane gas.



250,000 Btu/hr Input
MODINPDP250AE0185
UPC 046629440216
Min Buy 1 EA



Modine Tubular Natural Gas Heater

This power vented propeller heater is inexpensive to install, easy to use and offers excellent in-service economy. Features include: stainless steel tubular heat exchanger, thermal efficiency of 82%, power exhaust that can be rotated 180 degrees, 100% shut-off, direct spark ignition system with continuous retry and a safety pressure switch to assure safe venting conditions. Designed with 115V/60Hz/1 phase power and natural gas, single stage.



200,000 Btu/hr Input
MODINPTP200SS-0111
Min Buy 1 EA

250,000 Btu/hr Input
MODINPTP250SS-0111
Min Buy 1 EA

250,000 Btu/hr Input
MODINPTP250SS-0121
Min Buy 1 EA

300,000 Btu/hr Input
MODINPTP300SS-0111
Min Buy 1 EA

400,000 Btu/hr Input
MODINPTP400SS-0111
Min Buy 1 EA



Modine Natural Gas Heater

This power vented propeller heater is inexpensive to install, easy to use and offers excellent in-service economy. Features include: thermal efficiency of 83%, power exhaust that can be rotated 180 degrees, 100% shut-off, intermittent pilot-ignition system with continuous retry and a safety pressure switch to assure safe venting conditions. Designed with aluminized steel heat exchanger/burner, 115V/60Hz/1 phase power and 115V/24V IPI, 1 stg, natural gas.



150,000 Btu/hr Input
MODINPDP150AE0130
Min Buy 1 EA

250,000 Btu/hr Input
MODINPDP250AE0130
UPC 046629437155
Min Buy 1 EA

300,000 Btu/hr Input
MODINPDP300AE0130
Min Buy 1 EA



ona

Odor Mitigation

ONA® Spray Card

This small and portable ONA® spray card easily fits into pockets or purses. Take it with you to use anytime you suddenly need to eliminate bad odors.



Apple Crumble - 0.4oz OCMOLI15MCAC

UPC 624493111977
Min Buy 20 EA



ONA® Spray

Use anywhere unwanted odors are present. Simply spray into the air as needed! Ideal for eliminating smoke, pet and garbage odors.



Spray - Pro - 8oz OCMOLI250MCPRO

UPC 624493111441
Min Buy 12 EA

Apple Crumble - 8oz OCMOLI250MCAC

UPC 624493111472
Min Buy 12 EA

Fresh Linen - 8oz OCMOLI250MCFL

UPC 624493111427
Min Buy 12 EA



ONA® Liquid

Can be added to commercial misting systems, humidifiers or simply sprayed freely into the air to neutralize airborne odors on contact. Can also be used on fabrics or hard surfaces.



Fresh Linen - 31oz OCMOLI01LJGFL

UPC 624493112028
Min Buy 9 EA

Fresh Linen - 3.27L OCMOLI04LJGFL

UPC 624493113025
Min Buy 4 EA

Fresh Linen - 5gal OCMOLI20LJGFL

UPC 624493114022
Min Buy 1 EA



ONA® Gel

Our most versatile odor neutralizer provides sustained odor control in any situation. ONA® Gel evaporates neutralizer into the air to eliminate odors on a continuous basis. For larger areas, use with an ONA® fan such as the ONA® Breeze Fan and the ONA® Cyclone Fan.



Apple Crumble - 25.8oz OCMOGL01LJGAC

UPC 624493122072
Min Buy 6 EA

Apple Crumble - 8.5lb OCMOGL04LPLAC

UPC 624493123178
Min Buy 4 EA

Apple Crumble - 44lb OCMOGL20LPLAC

UPC 624493124076
Min Buy 1 EA

Fresh Linen - 25.8oz OCMOGL01LJGFL

UPC 624493122027
Min Buy 6 EA

Fresh Linen - 44lb OCMOGL20LPLFL

UPC 624493124021
Min Buy 1 EA

Pro - 25.8oz

OCMOGL01LJGPRO
UPC 624493122041
Min Buy 6 EA

Pro - 8.5lb

OCMOGL04LPLPRO
UPC 624493123147
Min Buy 4 EA

Pro - 44lb

OCMOGL20LPLPRO
UPC 624493124045
Min Buy 1 EA

Fresh Linen - 8.5lb

OCMOGL04LPLFL
UPC 624493123123
Min Buy 4 EA



ONA® Block

The ONA® Block odor eliminator is a powerful, cost-effective way to neutralize continuous odors in small spaces, such as cupboards, closets, litter boxes, gym bags, cars, RVs and boats.



Block - Pro - 6 oz. OCMOBK150DWPRO

UPC 624493141349
Min Buy 48 EA

Apple Crumble - 6oz OCMOBK150DWAC

UPC 624493141370
Min Buy 48 EA

Fresh Linen - 6oz OCMOBK150DWFL

UPC 624493141325
Min Buy 48 EA



ona

Odor Mitigation

ONA® Cyclone Fan

A cost-effective high-quality ONA® Gel Distribution System. This portable fan runs quietly and has 5 fan speed options to help you destroy the worst odor problems more cost effectively. The ONA® Cyclone fits onto the ONA® 44 lb (5 gallon) Gel pail – sold separately. Use in rooms up to 5000 sq ft. 12V power adapter included.



OCMOCY

UPC 624493168001

Min Buy 1 EA



ONA® Mist Dispenser

Use with ONA® Mist for timed and measured odor control in rooms and areas where odors are persistent and annoying. Settings include day/night/24hr with 7.5/15/30-minute intervals.



OCMOMD

UPC 624493166908

Min Buy 1 EA



ONA® Breeze Fan

When dealing with intense odors, you can open multiple gel pails or use the Breeze Fan on a single pail. The Breeze Fan increases the amount of neutralizer in the air so you can eliminate those strong odors more effectively. Fits on ONA® 25.8oz Gel Jar or the 8.5lb Gel Pail – sold separately. Use in room up to 1,500 sq ft. 12V power adapter included.



Work Up to 1,500sq ft

OCMOBR2

UPC 624493167004

Min Buy 1 EA



ONA® Mist

Neutralize odors in your office, warehouse, home, garage, bathroom or storage areas. Use with the ONA® Mist Dispenser to eliminate odors on a continuous basis.



Apple Crumble - 6oz

OCMOMT190GCAC

UPC 624493111373

Min Buy 12 EA

Pro - 6oz

OCMOMT190GCPRO

UPC 624493111342

Min Buy 12 EA



Trusted for
EXCELLENCE
in Odor Control

NEUTRALIZE
ODORS
NATURALLY

ona

www.onaonline.com



Racks & Carts / Curtain System

Food Grade Drying Trays

- 18in W x 25.5in L x 1.38in H
- Made of food grade Polypropylene (PP)
- Safe working temperature of 200° F max, 40° F min
- NSF approved
- FDA food contract approved
- For use in GMP facilities
- Perforated for excellent airflow and drying capabilities
- Cold, heat, stain and chemical resistant
- Easily sanitized
- Fits the DRYMAX drying system
- Can be barcoded for inventory control and asset management
- Sold in packages of 10
- Made in Canada



Modular Drying Rack

- Dimensions: 32in W x 62in L x 72in H
- Stainless steel
- Three (3) horizontal hanging bars are height adjustable
- 27 hanging rods
- Base tray removable to clean, and capture product
- 5" castors designed for use in food facilities
- Easy to clean and sanitize
- Posts are stainless steel



Propagation Cart

- Dimensions: 22in W x 53in L x 71in H
- Accommodates standard size
- Durable and sturdy all steel construction
- Specially painted with white FDA and NSF approved coating
- Easy to move and clean
- 5" castors NSF approved
- Includes white plastic trays
- Various growing levels provided: 3 and 4 level options



Light Deprivation Curtain Systems

The benefits of a VRE curtain system include:

- The precise and consistent control of your Daily Light Interval
- Our patented blackout seal provides the best closure in the greenhouse business
- Our installation and design ensures the fabric lasts as stated
- We bring over 40 years of expertise to each system we design, manufacture and install
- We can do retrofits, new builds, service and repair
- Light deprivation zones can be custom designed
- Custom designed light traps ensure excellent ventilation and temperature control
- Can be fully integrated into your control systems

Culture Shift

- Dimensions: 27 11/16in W x 51 21/32in L x 73 27/32in H
- Enables the effective use of fluid tissue culture
- Enhances the transfer of nutrients, thereby increasing the rate of plant growth and multiplication
- Tissue Culture is the next evolution in propagation



DryMax60 System

- Dimensions: 28in W x 61in L x 80in H
- Durable and sturdy all steel construction
- Stainless steel Grade 304
- Recommended for EU-GMP and GMP compliant facilities
- Also suitable for food and medical production facilities
- Easy to move, clean and sanitize
- Removable base for product capture and easy cleaning
- Fits 60 VRE Food Grade Plastic Drying Trays (sold separately)
- Space between trays is 3" high
- Comes standard with 5" Colson castors - designed specifically for food facilities



Contact your BFG Sales Rep

for pricing and customized solutions
for your operation.

Pro-Grow Supply Co.

Propagation

Pro-Grow Supply Propagation Mat

Place flats directly on this heavy rubber mat and get even bottom heat for starting seeds and cuttings. Instructions for use in each carton with mat. Thermostat sold separately.



22in x 60in / Cord 6ft / 200Watts @ 120Volts
/ 5 Flat Capacity / Shipping Weight 13lb

PGSPM-9A

Min Buy 1 EA



Pro-Grow Supply Gro-Control Thermostat

Heavy duty construction thermostat for control of up to 2 propagation mats.



Cord 6ft with series tap plug /
120V-720W-A8 Res, 1/6HP Ind

PGSGC-1

Min Buy 1 EA



Pro-Grow Supply Gro-Control Thermostat

Heavy duty construction with pilot light. Thermostat for control of up to 4 propagation mats.



Cord 6ft with grounding plug /
120V-1500W-12.5A Res, 1/6HP Ind

PGSGC-4

Min Buy 1 EA



ProKure®

Odor Mitigation

ProKure® D

ProKure D slow-release gas is the perfect solution for improving air quality and for on-going control of odors caused by mustiness, perspiration and more. 30-days of ClO₂ protection. Improves air quality. Suitable for use with plants in the room.



10gm Packet

CLRE010C12

Min Buy 12 EA

50gm Packet

CLRE050C12

Min Buy 12 EA



ProKure® G

ProKure G fast release gas is EPA-registered to clean the air you breathe and remove foul odors. Kills mold and mildew, odor-causing bacteria, and chemical odors. Used in agricultural facilities, greenhouses, commercial buildings, residential properties and more. For use in un-occupied, confined spaces.



10gm Packet

CLRF010C12

Min Buy 12 EA

25gm Packet

CLRF025C12

Min Buy 12 EA

25gm Packet

CLRF025CNC20

Min Buy 20 EA



Other

Twist II Clean® Filter

Just a gentle 1/4 twist of the handle begins the patented reverse flushing action, and the Twist II Clean backwashes itself from inside-out. Just a few seconds later, all debris is forcefully cleaned off the filter element and flushed from the bottom port



1in

LAK132067

Min Buy 1 EA





R3
RELIABLE
REDISTRIBUTION
RESOURCE.

PPE

R3 Safety™ Ansell Canner & Handler Glove

Ideal glove for safety and dexterity in the food processing industry. Made with natural rubber latex with a pinked cuff style and pebble embossed grip design. Glove features excellent dexterity, tensile strength and elasticity. The 20mil thickness provides good chemical, snag, puncture and abrasion resistance. Complies with FDA food handling requirements.



Size 10

R3220197035

Min Buy 1 DZ

R3 Safety™ Best® Nitrile Disposable Gloves

Powder free disposable glove that features a 4mil thickness, rolled cuff for easy donning, blue textured finish and industry standard 9.5in length.



Medium, 100pk

CCP97008-MED

UPC 038054382179

Min Buy 1 BX

Extra Large, 100pk

CCP97008-XLARGE

UPC 038054382193

Min Buy 1 BX

R3 Safety™ Disposable Particulate N95 Respirator 14110444

Strong and rigid outer shell. Form-fitted mask. Molded nose bridge. Electrostatic non-woven polypropylene polyester fibers. Dual welded head straps. Latex free woven suspension straps. Lightweight construction. Soft inner lining for extended comfort. Hypo-allergenic.



20/bx

R3341557865

Min Buy 1 BX



R3 Safety™ Moldex® Replacement Organic Vapors Filter Cartridge for Mask Respirator

100% PVC-Free® charcoal filter cartridge that can be used with both 7000 and 9000 series respirators. NOISH approved.



d

R322271001

Min Buy 1 PR

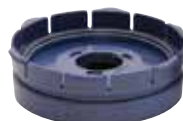

R3 Safety™ Moldex® 9000 Series Full Face Mask Respirator

Mask boasts an extra-wide viewing lens, with an over-molded flange design. At less than 13 ounces, the respirator is ultra-lightweight and has a convenient ratchet fastening strap system and a stand-away head harness that make putting the mask on and taking it off quick and easy. The strap tabs are securely molded directly to the flange for rugged use. It is completely free of metal parts, making it ideal for mines, refineries and other work environments where metal may be hazardous. Filters are sold separately.



Medium

R3222290021

Min Buy 1 EA

Large

R3222290031

Min Buy 1 EA



R3 Safety™ Moldex® 7000 Series Reusable Half Mask Respirator

Light weight design plus extra-wide sealing area provides all-day comfort. Mask drops down for convenient storage around the neck or locks down for custom fit. Adjustable head cradle and curved neck buckles for extra comfort. Low profile, compact design allows a wide field of vision, fits well under welding helmets and with safety glasses. NIOSH approved. Filters sold separately.



Medium

R3222270021

Min Buy 1 EA



R3 Safety™ DuPont™ Tyvek Jumpsuit With Hood

Offers a comfort fit design based on extensive wearer input to provide our most comfortable garment design that: enables a greater range of movement while stretching and bending.



3XL

R331710489

Min Buy 1 EA



R3 Safety™ DuPont™ Tyvek® White Coverall

Attached hood, elastic wrists and ankles all provide an effective barrier against hazardous drip particles and light non-hazardous liquid splash. Comfort fit design offers greater range of movement. Includes serged seams and a nylon zipper.



White - Medium

BMC31710485

UPC 888120014141

Min Buy 1 EA

White - Large

BMC31710484

UPC 888120014158

Min Buy 1 EA

White - Extra Large

BMC31710487

UPC 888120014165

Min Buy 1 EA





R3
RELIABLE
REDISTRIBUTION
RESOURCE.

PPE

R3® Safety™ Chemical Resistant Glove

Versatile chemical protection that performs across a diverse range of applications. High performance nitrile compound provides an outstanding combination of chemical resistance and strength. Offers superior snag, puncture and abrasion protection over rubber or neoprene gloves. Features straight cuff and sandpatch grip. Suitable for heavy-duty cleaning applications. High levels of flexibility, comfort and dexterity. Won't swell, weaken or degrade, and does not promote contact dermatitis. Complies with FDA food handling requirements.



XL - Box of 12
R33715510
Min Buy 1 BG



PPE

Bellingham® Nitrile TOUCH® Glove

Breathable 13-gauge seamless nylon knit liner. Abrasion and puncture resistant nitrile coating molds to the hand and fits like a second skin. Excellent dexterity. Six assorted colors; pink, orange, yellow, green, blue and purple.



Assorted Colors: Pink, Orange, Yellow,
Green, Blue & Purple - Large
AGLNT3700ACL
UPC 639751137231
Min Buy 12 EA



SUNBLASTER HORTICULTURAL LIGHTING

Propagation

SunBlaster™ Light Timer

It is a 24 hour mechanical timer. With twice the number of control pins of a standard mechanical timer, this timer gives you 15 minute precision. Non-removable timer pin design keeps pins safe and secure. Grounded outlet allows a wider variety of appliances to be used. Includes override switch.



24 Hour Analog Timer - Single Outlet
SBL1400599
UPC 628836145995
Min Buy 6 EA



Propagation

SunBlaster™ Heat Sheet

Warms the root area up to 20 degrees Fahrenheit (11 Celsius) over the ambient air temperature to improve germination and increase the success of seedlings and cuttings. Complete instructions printed right on the mat. Works with all 1020 trays.



10in x 20in - 17 Watts, 120 V
SBL1400517
UPC 628836145179
Min Buy 1 EA



SunBlaster™ NanoDome Mini Greenhouse Kit

A mini greenhouse makes propagation easy. This custom kit includes everything you need to start flower or vegetable seedlings, propagate fresh cuttings, or grow fresh herbs right in your kitchen all year long. Kit includes SunBlaster Nanodome, 18in T5HO 6400K light, SunBlaster Nanotech T5 Reflector and a double thick 1020 tray. Seed and soil not included.



SBL1600205
UPC 628836162053
Min Buy 1 EA



Other

SunBlaster™ Hang-Its Adjustable Hangers

A fully adjustable ratchet. Adjust the height of your grow lights in seconds, providing you the ultimate control over the distance between your plants and grow lights to any desired height above the plant.



2pk
SBL0900287
UPC 628836092879
Min Buy 6 EA



SOLO®

Sprayers

Solo® NOVA 424 Backpack Sprayer

Rugged SOLO® backpack sprayers are flexible and ergonomically designed for virtually any spraying task both large and small. Built for comfort. Built for convenience. Built to last. SOLO's ergonomic design contours to your back for greater comfort. A low number of wearing parts and sturdy technology ensure a long service life and minimum maintenance. The simple and effective design of the new Solo® Nova 424 Backpack Sprayer results in a reliable and comfortable product. The sprayer fulfills the basic requirements of demanding use around the home and on the farm. Large 4.75in tank opening. The large filter basket is easily removed. Durable shut-off valve for comfortable transport and easy maneuvering. Stable tank base ensures that the sprayer will not tip over when filling. Pump lever can be repositioned vertically to save space. 28in unbreakable wand and shut-off valve assembly provides excellent reach. The wand can be stored neatly in a wand holder, protected from dirt or damage by a special opening integrated in the tank base. Speed Tip Nozzle: multi-pattern spray. Sprays with 3 different settings with a turn of the dial: jet stream, flat spray and full cone mist. Durable shut-off valve with lock-on / lock-off feature reduces operator fatigue. 48in nylon-reinforced high-pressure hose for extended reach. Internal pump system incorporates an effective mixing system. While pumping, the liquid in the tank is constantly agitated.



4gal
SOL424NOVA
 UPC 720343004243
 Min Buy 1 EA



Solo® 425 Backpack Sprayer

Since its introduction to the US market in 1964, Solo's popular 425 backpack sprayer has been the standard by which all backpack sprayers are measured... and for good reason! High-density polyethylene tank with ultra-violet inhibitors allows for unmatched durability and ultra-violet protection. Large 4.25in opening for easy filling and cleaning. Shut-off valve and wand with an overall length of 28in for hard-to-reach places. 4ft high-pressure hose. Padded shoulder straps for greater comfort. Chemically resistant Viton® seals ensure long life and durability. With its connecting rod-activated piston pump, the 425 is capable of producing a wide pressure range of up to 90 psi, and is capable of performing virtually every spraying task. Easily and effectively handles disinfectants, fertilizers, herbicides, pesticides, and formulations for tree, shrub and plant protection and wood and concrete finishing and treatments.



4gal
SOL425
 UPC 720343425000
 Min Buy 1 EA



Solo® 441 Backpack Sprayer

Ideal for a variety of medium-to-large spraying jobs at home and on the farm, including general spraying, weed control, and gardening. Achieve optimal spraying coverage minus tiresome pumping with the 441's robust lithium-ion battery. Speed Tip Nozzle: multi-spray pattern. Sprays with 3 different settings with a turn of the dial: jet stream, flat spray and full cone mist. 4 gallon, UV-resistant HDPE tank with large 4.75" opening. The large filter basket is easily removed. 11V diaphragm pump, 37.5 PSI. 11V Lithium-ion Battery. Up to 4 hours running time. 2-hour charging time. Integrated carry handle for easy transport and maneuvering. Adjustable padded straps. 20 inch unbreakable wand provides excellent reach. The wand can be stored neatly in a wand holder, protected from dirt or damage by a special opening integrated in the tank base. Commercial shut-off valve with lock-on / lock-off feature reduces operator fatigue. 48" nylon reinforced high-pressure hose for extended reach. Stable tank base ensures that the sprayer will not tip over when filling.



4gal
SOL441
 UPC 720343424003
 Min Buy 1 EA



Solo® Handheld Pressure Sprayer

Chemical resistant Viton® seals in key locations withstand harsh chemicals for long service and durability. Commercial quality shut-off valve with lock-on/lock-off feature reduces operator fatigue. Funnel top for easy fill and large secondary opening for easy clean-up. Four-nozzle assortment: adjustable, flat fan, jet stream and hollow cone. TeeJet® compatible. Unique storage compartment for extra nozzles. Adjustable webbed nylon carry strap makes carrying easy.



2gal
SOL4302G
 UPC 720343432008
 Min Buy 1 EA



Solo® One-Hand Sprayer

This unique, one hand sprayer incorporates all the easy pump, easy fill, easy clean-up characteristics found on Solo sprayers. Features locking trigger for reduced user fatigue.



1L
SOL415
 UPC 720343415001
 Min Buy 12 EA



Solo® One-Hand Sprayer

One hand sprayer incorporates all the easy pump, easy fill, easy clean-up characteristics found on Solo sprayers. Features a unique fully adjustable nozzle, a drip/drift guard and a hinged, multidirectional wand assembly and a locking trigger for reduced user fatigue. With durable components and Viton® seals, repair and maintenance is easier than ever.



1L
SOL418
 UPC 720343418101
 Min Buy 1 EA
 2L
SOL420
 UPC 720343418200
 Min Buy 1 EA



Link4 CORPORATION

Controllers

Link4 iPonic Indoor Controller Line

The iPonic Indoor controller line is ideal for smaller indoor growing applications. Single or dual zones utilizing 8 outputs allows you to control most needs for indoor growing. The iPonic series of controllers is compatible with the Link4 Cloud, which will allow you to monitor, control, graph, report and receive alarm notifications.

Link4 iGrow 1800 Advanced Indoor or Greenhouse Controller

The iGrow 1800 offers the finest in greenhouse and indoor growing experience. Used for larger and more complex grow situations, the iGrow 1800, you can increase productivity while reducing energy use and operating costs. The iGrow 1800 series offers 24VAC intelligent controlled outputs that can be expanded up to 144 outputs for fans, heaters, vents, irrigation, supplemental light and DLI, shade curtains (blackout curtains), and more. Combine the iGrow 1800 with the iDoser to automate dosing and fertigation.

- Advanced control, affordable price
- 24VAC intelligent controlled outputs expandable up to 144 outputs
- Advanced irrigation (VDP or Soil Moisture Content)
- Advanced lighting control (DLI)
- Auxiliary controls are flexible and user defined to control conditions to fit your unique growing requirements
- UL Listed for safety and easy permits
- Runs off Linkconn software or with the new 1800 Cloud for remote accessibility



Link4 iGrow 800 Greenhouse Controller

Get real-time energy use and track run-time on greenhouse heating and cooling equipment with this easy-to-use controller system.



L4990080002

Min Buy 1 EA



Link4 iPonic Commercial Indoor Controller

The iPonic commercial series of is similar to the standard single and dual zone iPonic controllers except that the equipment is wired through included contactors rather than 120-volt outlets. This will provide you greater flexibility than the standard line of iPonics.



Single Zone

L4995360008

Min Buy 1 EA

Dual Zone

L4995360208

Min Buy 1 EA



Link4 iPonic 614 Indoor Controller - Single Zone

The iPonic 614 is a single-zone controller that includes 8 120-volt outlets of which 6 are fully-programmable. They are available for a combination of devices such as central air conditioning, heaters or any device with a remote thermostat connection. Controller includes a single Digital Integrated Sensor Module (DISM) that measures temperature, humidity, CO2 and lighting.



L4995110000

Min Buy 1 EA



Link4 iPonic Indoor Controller - Dual Zones

The iPonic 624 allows you to share the 8 120-volt outlets into 2 zones eliminating multiple controllers for multiple functions. The iPonic 624 comes with two Digital Integrated Sensor Modules (DISM) controlling CO2, light timer, irrigation, temperature, humidity, recycle timers, vent fans, high temperature shut-off, central air conditioning and heating – even add your own custom devices.



Dual Zone 624

L4995112400

Min Buy 1 EA

Link4 Weather Station

Measures light, wind speed, wind direction, outside temperature, and rain.



For iGrow 100 Series Model

L4990000503

Min Buy 1 EA

Link4

CORPORATION

Controllers

Link4 Indoor Digital Temperature & Humidity Sensor

Indoor digital temperature and humidity sensor.



For iGrow 100 Series Model

L4990025000

Min Buy 1 EA

Link4 iPonic Alert Hydroponic Alarm

A cloud-based monitoring and alarm system. With simple plug-and-play functionality, any grower can learn what is going on in their grow room – from any Internet connected device. The iPonic Alert is ideal for the cultivator that is satisfied with their current controls, but wants the extra assurance of push notifications sent to their smart phone in the event anything should go wrong.



Single Zone

L4990070100

Min Buy 1 EA

Dual Zone

L4990070102

Min Buy 1 EA

SENSAPHONE®

Controllers

Sensaphone® Monitoring System

Offers small-business owners, vacation property owners, and other property managers an easy and inexpensive way to monitor a remote facility. When the system is connected to a standard telephone line, users can record custom "Alert Condition" notifications and receive alarm messages in their own voice. This system can set off a local alarm if a phone line is cut and control a thermostat to adjust site temperature between two set points. Nonvolatile memory retains system settings in the event of power loss. The status of each monitored condition is readily obtained at the unit's installation site or remotely by telephone. Up to four external sensors monitor temperature, humidity, water and more. No monthly fees.



Temperature-sensing range

20 to 150 degrees F.

SENSPFGD-0400

UPC 049961970298

Min Buy 1 EA



SIEBRING

Sprayers

Siebring Mfg Mist 'R Drencher Sprayer

Quick connect for draining or washing polyethylene tank (lid included). Ball bearing mounted hose reel for 250ft playout and rewind. Includes 3 piece nozzle for high or low misting, 1 drenching water breaker screen nozzle, 1 18in wand and 1 12in wand, 1 12in curved (hook) extension for hanging baskets, back flush connector for easy cleaning, 0 degree to 15 degree pressure nozzle and 100ft wire braid hose. Has hose reel and high pressure gun. Constant agitation suspends wettable powders. Many options, including stainless.



Electric or Gas / 800psi / 3gpm Flow /
10in "No Flat" Tires

SMKMD83BW

Min Buy 1 EA



Siebring Mfg Kruser Sprayer

Features bottom tank drain and sump in tank for maximum usage. Includes a mist nozzle assembly, an 18in wand and 100ft 1/4in wire braid hose. Has hose reel and high pressure gun. Constant agitation suspends wettable powders. Many options, including stainless.



Electric / 750psi / 1.5gpm Flow / 25ft
Electrical Cord / 10in "No Flat" Tires /
25gal Poly Tank

SMKKS750-125

Min Buy 1 EA



Gas / 750psi / 1.5gpm Flow / 10in "No Flat" Tires /
25gal Poly Tank / 4hp Gas Engine

SMKKS-750-100

Min Buy 1 EA





Controls

Cultivation of vegetables

The cultivation of fruiting vegetables requires maximum flexibility to enable growers to control the greenhouse climate and water dosage in their own way. Priva offers every possible option for this.

- Growing the best climate
- Easy to use
- Balance your growth
- More Insight



Cut flowers

The flower is the most sensitive plant organ, so as a cut flower grower you need a great deal of care during cultivation. We understand that the greatest challenge for growers of cut flowers is to keep the climate conditions as constant as possible. Advanced control, affordable price

- Optimum quality
- Minimum consumption of energy



Soft fruit

When growing soft fruit, precision growing is crucial. You want to maintain a consistent year-round supply of fresh fruit, while reducing the cost of production. To guarantee success and create continuity, it is important to provide the ideal growing conditions for your crop.

- The best possible growing conditions
- A more sustainable business
- Efficient water and fertilizer dosing
- Improved labor and production efficiency



Potted plants: create the best conditions for crop planning

The wide variety of crops present a challenge. In the case of green plants, for instance, different species are often placed together. Each with their own climate requirements. We know planning is crucial for you as a potted plant grower to reach the optimum size and quality of your crop.

- Maximum reuse of water
- Global service work
- The perfect crop planning
- Control climate water dosage and light





Controllers

System Access

An Argus Server PC is used to access control system information and adjust control settings. This can be any standard PC running the Microsoft Windows operating system. The Argus Server PC also performs housekeeping duties such as storing long-term archival data and backup copies of all control and system configuration settings in the controllers. The Server PC provides password-protected access to the control system enabling authorized users on other PCs to connect to the system via wired or wireless Ethernet networks and the Internet.

Controllers

Argus Titan II controllers are the powerhouses at the heart of the Argus system. We custom program each one to manage your specific applications. They are fast, rugged, highly configurable, and can run more applications than most controllers in their class. They can also be easily networked together for seamless control of any sized facility.

- Separated I/O
- Dedicated Control
- Seamless Integration

I/O (Input/Output)

Argus Controllers use slaved I/O Modules for high-resolution data acquisition from connected sensors and precision equipment control. We also provide UL listed interfacing equipment as needed for switching line voltage motor loads.

- I/O Modules
- Sensors
- Equipment Control
- Line Voltage Interfacing

Multi-Feed Nutrient Injection

Argus Multi-Feed injectors including the Multi-Feed RM are designed and manufactured exclusively by Argus and feature some of the most advanced capabilities of any nutrient control equipment including full single-element dosing options. The injectors are capable of 'on-the-fly' delivery of multiple stock concentrates regardless of the system flow rate. With a Multi-Feed injector, you can use the same dosing equipment to deliver dozens of different recipes. You can also modify the feed concentration and chemistry to suit the current conditions. Fully integrated with the comprehensive irrigation and fertigation capabilities of the Argus Titan system, Multi-Feed injection systems enable you to simply 'dial-in' a precision feeding program for every crop.



Software

Titan 900 Software

The Titan 900 software offers an enhanced user experience with innovative visual controls and value added features (such as intuitive visual controls, enhanced graphs, API, and smart reporting). The refreshed user interface uses color and layout strategies that can be customized to suit individuals' need for style and information. Our software is designed to de-clutter the interface, optimize visualization of your facility's data, and focus your attention on what is important to you.

Argus Live

With a live view of your operation, you can monitor, analyze, and run your facility in real time, giving you full control whether you're at your desk or on the move. It is a safe, secure, and powerful enhancement to one of the most advanced environmental control systems on the market.

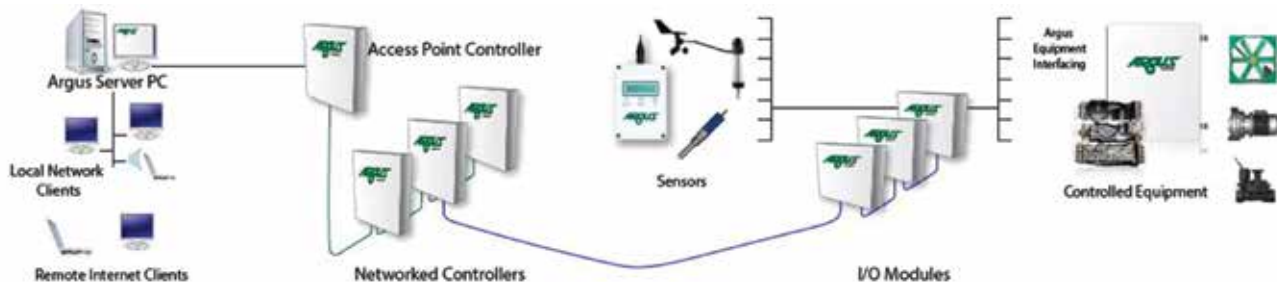

Other Equipment

WADS VC -2000/ILS 1-3/8in O.D. Shaft

Wadsworth's most powerful drive unit. It meets the challenge of long vent runs and heavy vents. With its quiet running, low current, high output motor, the VC-2000 keeps your utility bills low. It can lift 325 feet of 4 foot polycarbonate roof ridge vent with aluminum frame on rack and pinion.



1.2 RPM

WADSM1190 Min. Buy 1ea



3.2RPM

WADSM1550 Min. Buy 1ea



Wadsworth Driveshaft Coupling

Coupling to join two lengths of drive shaft.



1 3/8in

WADSF0909 Min. Buy 1ea

Wadsworth Seed®

A sophisticated new touchscreen climate control so intuitive it makes managing multiple zones a snap. Our most capable control to date.

- Highly intuitive – the easiest control you'll ever operate!
- Newest most responsive touchscreen technology
- Extensive information at a glance
 - Equipment Status lists current conditions
 - Why Code displays explanation for equipment status
- Easy navigation
- Modular design allows for easy expansion
- Remote access
- Precision control of your crop
- View equipment settings, overrides, lockout and setpoints from a single screen
- Manages fertigation using the H.E. Anderson J+ system



Wadsworth Seed® 16

Seed 16 is identical to Wadsworth's popular Seed control, but made for small-scale needs.

- Functionality and intuitive graphic interface
- Design accommodates beginners and experts
- 16-outputs, enough to support standard greenhouse cooling, heating, HAF fans, pad pump, plus lighting and irrigation
- Configured to suit grower needs, multiple zones, single zone; your choice
- Flexible electrical panel built for custom equipment
- 16-inputs – enough to support temperature and humidity sensors, an exterior weather station and multipl other sensors, like soil moisture and CO2
- Advanced sensing options include dissolved oxygen (DO), tank electrical connectivity (EC), tank pH an differential pressure (Sensors require inputs)
- Expandable

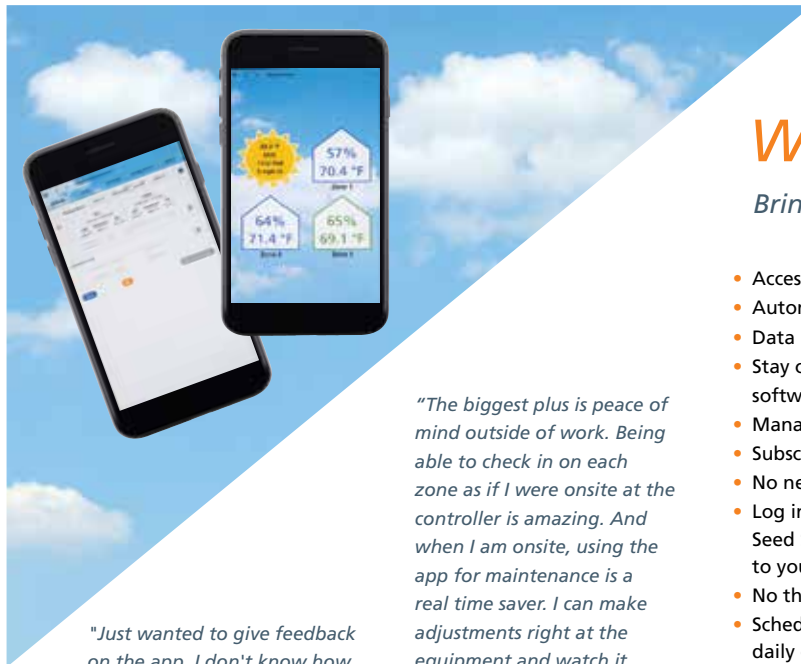

Wadsworth.Cloud

Bring the power of Seed control home

- Access the app on your iPhone, Android or computer
- Automatically saves your settings daily or weekly
- Data is backed up to the Cloud
- Stay current with auto notifications for the latest software updates
- Manage multiple sites – great for consultants
- Subscription based
- No need to remote in to an onsite computer
- Log in off-site to access your Seed controls via Seed Sphere for quick and easy changes to your settings
- No third-party software required
- Scheduled snapshots, available daily or weekly as backup
- Same secure environment as on your control

"Just wanted to give feedback on the app. I don't know how I was operating without it. It's made my life so much easier, and it's clear that it will be even more valuable as we continue to ramp up."

— Jonathan Nelson
Greenleaf Gardens, LLC, Ohio

"The biggest plus is peace of mind outside of work. Being able to check in on each zone as if I were onsite at the controller is amazing. And when I am onsite, using the app for maintenance is a real time saver. I can make adjustments right at the equipment and watch it respond. I love the identical interface on all devices, the controller, the computer and the app are all the same. There's no learning curve."

— Danny Janes
Collective Elevation, Montana

Gardener Select



bird baths - garden stakes - planters - watering cans - gazing globes - and more

SHARP PRICE POINTS
QUALITY IS EXCELLENT AND
PRODUCTS ARE EXCLUSIVE

For More Information
Contact your BFG Sales Consultant or visit www.bfgsupply.com today!



HARVEST &
Storage

HarvestMore®

Trimmers & Cleaners

Harvest More® Trim Bin Complete Set

The Trim Bin trim tray by Harvest-More features an ergonomic design that makes trim work more enjoyable. The two part system allows for versatility and efficient use of space. Like all products in the Harvest More line, the HM trim tray is made with quality materials and ingenuity. It's long lasting, durable and portable. Turn any couch or table into a comfortable work station!



Black
HMP001
 UPC 713757640237
 Min Buy 1 EA



Harvest More® Trim Bin Filter

The Trim Bin Filter features a sorting screen at its base that allows you to quickly separate unwanted sizes and materials into the attached collection bag.



20in x 16in x 8in
HMP002
 UPC 713757649735
 Min Buy 5 EA



Harvest More® Trim Bin Bottom Only

The Bottom Bin is an excellent option for wet work. It features the same durable construction and ergonomic support.



Black
HMP003
 UPC 860003200124
 Min Buy 1 EA



Harvest More® Scissor Scrubber

Say good-bye to gross gummy blades, sticky rags and sloshy jars — the Scissor Scrubber gets the job done without a big fuss and NO MESS!



Green
HMP006
 UPC 713757639934
 Min Buy 5 EA



Harvest More® Bag Holder

Trim Bin Bag Holder clips to the edge of Trim Bin to hold bags open and ready for use while you work. The Bag Holder clips easily to all models of Trim Bin and makes trimming even more efficient! Trim Bin Bag Holder supports trim-phase sorting and classification for botanicals and helps to keep your space organized.



Green & White
HMP007
 UPC 713757649636
 Min Buy 1 EA



Harvest More® Replacement Screen

Collect pollen while using Trim Bin with our innovative screens.



150 micron
HMP004
 UPC 713757640039
 Min Buy 50 EA

220 micron
HMP005
 UPC 713757640336
 Min Buy 50 EA





Bags & Jars

INTEGRA™ Dry Bucket

Each bag absorbs 158% of its weight in moisture and will not absorb below 50% humidity. In addition, they will reduce unwanted odors, and mold.



200g
DESSNDBUCKET
Min Buy 30 EA

INTEGRA™ StripHang

Strip to control moisture in any areas where excess moisture is a problem. The convenient attached hook allows for simple hanging in cabinets, pantries and more.



1000g
DESCDPBOOST
UPC 008023590005
Min Buy 6 EA

Kerr® Humidity Control Jar with Integra Boost

Kerr® Jars have become a staple for anyone's stash. Now the Kerr® air-tight glass jars have partnered with Integra to create the perfect Humidity Control Jars. The classic mason jar now includes a Pack Holder for your Boost. This way your dried herbs are stored in a maintained humidity level.



DESKERR04A62KIT
Min Buy 4 EA



Kerr® Humidity Control Replacement Kit

Kerr® Humidity Control Replacement Kit are now available for your wide mouth mason jars. This kit comes with Integra Boost humidity control packs and the holders to go with them. Protect your product by maintaining the perfect relative humidity level of 62%.



DESKERR04A62REPL
Min Buy 6 EA

INTEGRA BOOST® 55% RH 2-Way Humidity Control

Our 2-way humidity control technology expertly adapts to the air around it absorbing or adding moisture as needed to maintain ideal relative humidity (RH) in any enclosed environment.



1g
DESB01A55J
Min Buy 3500 EA

2g
DESB02A55J
Min Buy 2000 EA

4g
DESB67A55A
UPC 802359000508
Min Buy 100 EA

4g
DESB04A55B
UPC 108023590004
Min Buy 600 EA

4g
DESB04A55F
UPC 802359000645
Min Buy 200 EA

4g
DESB04A55J
UPC 802359000812
Min Buy 1000 EA

8g
DESB08A55B
UPC 108023590004
Min Buy 300 EA

8g
DESB08A55F
UPC 802359000604
Min Buy 576 EA

67g
DESB67A55C
UPC 802359000567
Min Buy 12 EA



INTEGRA BOOST® 62% RH 2-Way Humidity Control

Our 2-way humidity control technology expertly adapts to the air around it absorbing or adding moisture as needed to maintain ideal relative humidity (RH) in any enclosed environment.



1g
DESB01A62J
Min Buy 3500 EA

2g
DESB02A62J
Min Buy 2000 EA

4g
DESB67A62A
UPC 802359000515
Min Buy 100 EA

4g
DESB04A62F
UPC 802359000652
Min Buy 200 EA

4g
DESB04A62B
UPC 108023590004
Min Buy 600 EA

4g
DESB04A62FCA
UPC 802359001413
Min Buy 800 EA

4g
DESB04A62J
UPC 802359000829
Min Buy 1000 EA

8g
DESB08A62B
UPC 108023590002
Min Buy 300 EA

8g
DESB08A69B
UPC 008023590009
Min Buy 300 EA

8g
DESB08A62F
UPC 802359000611
Min Buy 576 EA

67g
DESB67A62C
UPC 802359000317
Min Buy 12 EA





Bags & Jars

INTEGRA™ Humidity Packs

Our patented technology will either release or absorb moisture, maintaining relative humidity in a contained environment.



37mm, 55%
DESB37M55J
Min Buy 3500 EA

45mm, 62%
DESB45M62J
Min Buy 3500 EA



37mm, 62%
DESB37M62J
Min Buy 3500 EA

51mm, 55%
DESB51M55J
Min Buy 3500 EA

45mm, 55%
DESB45M55J
Min Buy 3500 EA

51mm, 62%
DESB51M62J
Min Buy 3500 EA

INTEGRA™ Humidity Individual Pack

Our patented technology will either release or absorb moisture, maintaining relative humidity in a contained environment.



8g, 72%
DESB08A72B
UPC 008023590009
Min Buy 300 EA

67g, 69%
DESB67A69A
UPC 008023590009
Min Buy 100 EA

67g, 55%
DESB67A55D
UPC 802359000577
Min Buy 192 EA

67g, 72%
DESB67A72A
UPC 008023590009
Min Buy 100 EA

67g, 62%
DESB67A62D
UPC 802359000553
Min Buy 192 EA

INTEGRA™ Humidity Indicators Card Pack

Use our humidity indicator cards to determine the humidity levels (or relative humidity, "RH") in a contained environment. Each pack contains 10 humidity-indicator cards, and each card will read RH from 10%-60%. Simply place a single card in the area to be read and wait for the indicator dots to turn bright blue in order to determine the humidity levels in that area.



10pk
DES04IB14C29
UPC 802359000560
Min Buy 360 EA



GROVE BAGS

Bags & Jars

Grove Bags TerpLoc™ UV Pouch

TerpLoc™ creates the optimal microclimate for storing cannabis by regulating the relative humidity in the packaging while protecting your product from exterior elements that would degrade its quality. TerpLoc™ is designed to provide peace of mind.



Holds 1gr
GRBTU7224001G1000
UPC 680193722400
Min Buy 1 CS

Holds 1oz
GRBTU7223631O1000W
UPC 680193722363
Min Buy 1 CS

Holds .125oz
GRBTU72239418O1000
UPC 680193722394
Min Buy 1 CS

Holds .25 Lb
GRBPO722127250
UPC 680193722127
Min Buy 1 CS

Holds .25oz
GRBTU72238714O1000
UPC 680193722387
Min Buy 1 CS

Holds .5lbs
GRBTU93459112P200
UPC 680665934591
Min Buy 1 CS

Holds .5oz
GRBTU72237012O1000
UPC 680193722370
Min Buy 1 CS

Grove Bags TerpLoc™ Ultraclear Pouch

TerpLoc™ creates the optimal microclimate for storing cannabis by regulating the relative humidity in the packaging while protecting your product from exterior elements that would degrade its quality. TerpLoc™ is designed to provide peace of mind.



Holds 1gr
GRBTC7223321G1000
UPC 680193722332
Min Buy 1 CS

Holds .5lbs
GRBTC72232512P200
UPC 680193722325
Min Buy 1 CS

Holds .125oz
GRBTC93457718O1000
UPC 680665934577
Min Buy 1 CS

Holds 2lbs
GRBTC934836250
UPC 680665934836
Min Buy 1 CS

Holds .25oz
GRBTC72235614O1000
UPC 680193722356
Min Buy 1 CS

Holds 5lbs
GRBTC934751100
UPC 680665934751
Min Buy 1 CS

Holds .5oz
GRBTC72234912O1000
UPC 680193722349
Min Buy 1 CS

Holds 10lbs
GRBTC934805100
UPC 680665934805
Min Buy 1 CS

Holds 1oz
GRBTC9346071O1000
UPC 680665934607
Min Buy 1 CS





Bags & Jars

Grove Bags Fresh Frozen Clear No UV Bag

Fresh Frozen Pouches are made from our specialty instant quick freeze film. Our unbranded Fresh Frozen bags come in two sizes: a 450 gram capacity pouch for small batch runs and a 2,000+ gram capacity commercial pouch for larger runs. Both sizes come with a white area in the bottom right of the bag to write on so you can keep track of weight and strain.



14in x 14in

GRBIQ934560250

UPC 680665934560

Min Buy 1 CS

20in x 24in

GRBIQ934584100

UPC 680665934584

Min Buy 1 CS



Grove Bags Wicket Bag

Grove Bags Wicket Bags are perfect for all of your bulk storage needs. They are made from our patented TerpLoc™ film with added UV protection, and come in two sizes. Both sizes come with 100 bags preloaded on a wicket to help streamline your process and improve efficiency. The small size can line a 5-gallon bucket and the large size fits into a 27-gallon tote when full. Never use a terpene-destroying turkey bag again!



Small - 18in x 22in

GRBWI722103500

UPC 680193722103

Min Buy 1 CS

Large - 24in x 40in

GRBWI722110200

UPC 680665934966

Min Buy 1 CS



Grove Bags SuperSac

TerpLoc™ creates the optimal microclimate for storing cannabis by regulating the relative humidity in the packaging while protecting your product from exterior elements that would degrade its quality. TerpLoc™ is designed to provide peace of mind.



36in x 36in x 72in

GRBSS934928X

UPC 680665934928

Min Buy 1 CS



Grove Bags Plst Preroll Doob Tube

Child resistant pre-roll tubes are an easy, convenient, and safe solution for packaging pre-rolls. Made from recyclable medical-grade BPA-free polypropylene plastic and feature a positive seal for enhanced freshness. The odor-tight seal significantly decreases odor to ensure secure storage and privacy.



White 116mm 1000pc

GRBPPCRWHITE1000

UPC 680665934973

Min Buy 1 CS

Grove Bags Preroll Unprinted

A product line is the evolution in packaging the cannabis industry has been waiting for. Designed around the plant's physiological properties, it utilizes a blend of several film elements to create the optimal cannabis climate inside every package.



0.5g 84mm 900pc

GRBPRCONESNOBRAND84

UPC 680665934959

Min Buy 1 CS

0.8g 98mm 800pc

GRBPRCONESNOBRAND98

UPC 680665934942

Min Buy 1 CS

1.2g 109mm 800pc

GRBPRCONESNOBRAND109

UPC 680665934935

Min Buy 1 CS

Grove Bags Liner

Grove Bags liners utilize the benefits of our Terploc™ film with increased industrial strength and puncture resistance for both 27-gallon totes and 55-gallon drums, making them the perfect option for storing & transporting large quantities of flower or trim.



27gal

GRBLI72215850

UPC 680193722158

Min Buy 1 CS

55gal

GRBLI72217250

UPC 680193722172

Min Buy 1 CS



FISKARS®

Trimmers & Cleaners

Fiskars® Big Grip Knife

A multi-purpose garden knife designed to weed, plant, split, transplant and more. Corrosion resistant blade has precision ground edge for cutting through sod and roots, and a serrated edge for sawing through thick growth. Oversized grip provides comfort and control.



FIS3707901008

UPC 046561170790

Min Buy 4 EA



Fiskars® PowerGear™ Bypass Pruner

Gives you up to 3.2x more power on every cut; powers through tough stems and branches better than traditional pruners. Makes cutting dramatically easier than it is with other tools. Fully hardened steel blade stays sharp, even through heavy use.



0.75in Cutting Capacity

FIS3910411001

UPC 046561291044

Min Buy 6 EA



Fiskars® Micro Tip Pruning Snips

Precision blades cut all the way to the tip for clean, healthy cuts in tight spaces. Fully hardened, precision-ground stainless steel blades stay sharp. Awarded Arthritis Foundation's Ease of Use commendation. Easy action spring for ease of use. Soft grip touchpoints for comfort. Lifetime warranty.



FIS3992401003

UPC 046561006549

Min Buy 6 EA



Fiskars® Micro-Tip® Pruning Shears

Shape and trim plants and flowers to encourage healthy growth with the precision blades on Fiskars® Micro-Tip® Pruning Shears. Perfect for reaching into tight spaces for intricate snips, these pointed blades cut all the way to the tip for clean, precise, healthy cuts and feature fully hardened, stainless steel blades with a precision-ground edge for long-lasting sharpness - even through heavy use. Extra-large handle loops leave plenty of space for gardeners with larger hands or those wearing gloves, while Softgrip® touchpoints enhance comfort and control. An included blade cover protects the blades when not in use.



3.75in W x 7in L x .75in H

FIS3992301001

UPC 046561006525

Min Buy 6 EA



Fiskars® Non-stick Micro-Tip® Pruning Snips

Fiskars® Non-stick Micro-Tip® Pruning Snips feature precise blades that cut all the way to the tip for clean, healthy cuts on plants in tight spaces. Non-stick blade coating helps reduce jamming, while fully hardened, precision-ground, stainless steel blades stay sharp through heavy use. Awarded the Arthritis Foundation's Ease of Use? Commendation for a design that's ideal for those with arthritis or limited hand strength. Easy Action™ spring-action design gently opens blades after each cut to help reduce fatigue, while Softgrip® touchpoints enhance comfort & control. Full lifetime warranty.



FIS3992411001

UPC 046561006594

Min Buy 6 EA

2pk

FIS3992411002

UPC 046561006600

Min Buy 6 EA



Fiskars® Power-Lever® Extendable Bypass Lopper

Ideal for cutting thick branches. Power-Lever® technology multiplies leverage to give you up to two times more cutting power than traditional single-pivot loppers. Extendable handles make cutting high branches or cutting at awkward angles easy. Fully hardened, precision-ground steel blade stays sharp, even through heavy use. Low-friction coating helps the blade glide through wood, prevents the blade from gumming up with sap and debris and helps the blade resist rust. Softgrip® touchpoints enhance comfort and control. Steel construction provides lasting durability.



25in - 37in L / 1.75in Cutting Capacity

FIS3916811009

UPC 046561191689

Min Buy 6 EA



Fiskars® Pro Bypass Pruner

Fully hardened, precision-ground steel blade stays sharp, even through heavy use. Low-friction coating helps blade glide through wood, prevents the blades from gumming up with sap and debris and helps the blades resist rust. Self-cleaning sap groove keeps the blade from sticking for easy operation. All-steel design provides excellent durability for lasting value. Non-slip grips. Easy-open lock protects the blade during transport and storage.



FIS3910911013

UPC 046561191092

Min Buy 1 EA



Trimmers & Cleaners

Aurora Innovations Sap Off Soap

A unique and powerful hand and tool cleaning soap. Made from gentle mineral oil and citrus extracts Sap Off Soap works quickly to cut resins, oils, sap and even inks or certain stains from surfaces such as skin, tools, containers and countertops.



4oz

AURAIOS4

UPC 609728632113

Min Buy 12 EA

8oz

AURAIOS8

UPC 609728632120

Min Buy 12 EA

16oz

AURAIOS16

UPC 609728632137

Min Buy 12 EA

1gal

AURAIOS1GAL

UPC 609728632144

Min Buy 4 EA



Gardener Select

Trimmers & Cleaners

Gardener Select® Bypass Pruner

Upper Blade: High carbon SK-5 steel, Non-Stick PTFE coated blade
Lower Blade: Middle carbon 50C steel, Black finished Aluminum handle with PVC grips



8.5in

GSAJH729

UPC 049121374836

Min Buy 6 EA



Gardener Select® Multi Function Scissors

Blades: Stainless Steel 420J2 PP/fiberglass
Plastic handles with Soft TPR grips



8in

GSAJH8231

UPC 049121374898

Min Buy 6 EA



Gardener Select® Precision Curved Blade Pruner

Upper Blade: High carbon SK-5 steel, Black finished, curved blade
Lower Blade: High carbon SK-5 steel, Black finished, curved blade ABS Plastic handle with Soft TPR Grips



7.5in

GSAJH803AT

UPC 049121374881

Min Buy 6 EA



Trimmers & Cleaners

TNB Naturals Trimming Shears

TNB Trimming Shears have been designed for maximum comfort and ease of use; the spring loaded action makes for effortless trimming of your plants and flowers. TNB Trimming Shears are a high-quality product featuring surgical stainless steel blades and soft rubber grips that cushion the hand.



Curved Blade

TNB007

UPC 019962590511

Min Buy 12 EA



TNB Naturals Trimming Shears

TNB Trimming Shears have been designed for maximum comfort and ease of use; the spring loaded action makes for effortless trimming of your plants and flowers. TNB Trimming Shears are a high-quality product featuring surgical stainless steel blades and soft rubber grips that cushion the hand.



Straight Blade

TNB006

UPC 083832074715

Min Buy 12 EA





Introducing

POT POPPER

ORGANIC INSECT CONTROL

CONTROLS FUNGUS GNATS



- Treats fungus gnats, root aphids, and more.
- Patented biodegradable pouch, just pop, drop and water.
- Infused with nematodes that will remain in your plants soil until insect larvae has been controlled.
- More advantageous for potted plants, gardens and commercial scale operations.
- Proven to increase plant root & shoot yield while also controlling pest populations.



Scan to Learn More About Pot Popper



Office: 905-686-9909
Fax 905 686-0357

sales@environmentalfactor.com
www.environmentalfactor.com



The image shows the interior of a large greenhouse. The ceiling is a complex metal truss structure with translucent panels. The floor is covered with rows of plants. On the left, there are rows of reddish-purple plants. On the right, there are rows of green plants. A central white diamond shape is overlaid on the image, containing the word "COVERINGS" in black capital letters. The diamond is surrounded by a thick, semi-transparent gold border.

COVERINGS



Infra Red Film & Clear Film

Dura-Film® Super4™

Dura-Film® Super 4™ offers the best value in a 6-mil, 4-year greenhouse film with the following improved properties over AT's older generations of greenhouse coverings. Superior strength and toughness. Higher light transmission. Guaranteed longer life – 4 years. Folds up to 210% stronger. Tear strength up to 164% higher. Puncture force up to 12% higher. Advanced UV up to 33% longer life.

SUPER4™
Greenhouse Film

16ft X 100ft

AT6750070

Min Buy 1 RL



24ft X 100ft

AT6750063

UPC 683706500632

Min Buy 1 RL



24ft X 150ft

AT6750085

UPC 683706500854

Min Buy 1 RL



28ft X 100ft

AT6750038

UPC 683706500380

Min Buy 1 RL



32ft X 100ft

AT6750042

UPC 683706500427

Min Buy 1 RL



40ft X 150ft

AT6750039

UPC 683706500397

Min Buy 1 RL



42ft X 100ft

AT6750084

UPC 683706500847

Min Buy 1 RL



48ft X 100ft

AT6750043

UPC 683706500434

Min Buy 1 RL



48ft X 150ft

AT6750045

UPC 683706500458

Min Buy 1 RL



48ft X 150ft

AT6750045

UPC 683706500458

Min Buy 1 RL



50ft X 100ft

AT6751236

Min Buy 1 RL



Dura-Film® Thermax

Every grower strives to produce the best crop they can while keeping production costs to a minimum. Dura-Film Thermax greenhouse poly combines all of these extras into one package. Superior drip control, energy savings, and bee compatibility are all packaged together to provide growers with one film at one cost. Dura-Film® Thermax is available in a selection of stock sizes and is available during certain "runs or campaigns" at predetermined widths without minimums. All other widths are considered custom product.



24ft x 100ft

AT8963765

UPC 683706682123

Min Buy 1 RL

THERMAX™
Anti-condensate Film

32ft x 100ft

AT8963766

UPC 683706682130

Min Buy 1 RL

36ft x 100ft

AT8963892

Min Buy 1 RL

40ft x 100ft

AT8963767

UPC 683706682147

Min Buy 1 RL

42ft x 100ft

AT8963888

Min Buy 1 RL

48ft x 100ft

AT8963858

Min Buy 1 RL



Green.tek

Poly Carbonate

Green-Tek® Thinwall Clear ThermaGlas®

Thermaglas multi-wall polycarbonate sheets offer high light transmission, maximum impact resistance, and superior insulation. This combination yields a strong, energy efficient, and lightweight sheet that is optimum for greenhouse applications. ThermaGlas Plus products feature built-in condensation control so durable and effective it's warranted for 10 years. The result is higher light transmission and reduced moisture-related disease. ThermaGlas 8mm triple-wall polycarbonate offers excellent light transmission, while providing up to 60% more energy efficiency than glass, and 25% more efficiency than 8mm twin-wall acrylic.



8mm - 71.25in x 9ft

GRTKTWIN-71.259

UPC 049961978478

Min Buy 1 PC



8mm Clear / 72.25in x 10ft

GRTKTWIN-71.2510

UPC 049961978409

Min Buy 1 PC



8mm - 71.25in x 11ft

GRTKTWIN-71.2511

UPC 049961981454

Min Buy 1 PC



8mm - 71.25in x 13ft

GRTKTWIN-71.2513

UPC 049961976498

Min Buy 1 PC



8mm - 71.25in x 14ft

GRTKTWIN-71.2514

UPC 049961978379

Min Buy 1 PC



8mm - 71.25in x 20ft

GRTKTWIN-71.2520

UPC 049961980525

Min Buy 1 PC



Green-Tek® ThermaGlas® Twin-Wall

ThermaGlas® Multi-wall Polycarbonate Sheet is designed and engineered specifically for commercial greenhouse use. The multiwall design and light weight of the sheet enables a reduction in the cost of the supporting structure. Shatterproof polycarbonate coupled with integrated UV resistant co-extruded layer yields long service periods.

Available in white/black/white. 0% Light Transmission - 100% Opaque. Green-tek light deprivation multi wall polycarbonate sheets are a popular choice for specialty greenhouse side and end walls, retail garden spaces, roofing applications, cold storage, hood houses, clean rooms, service buildings, walkways, partitions and more.

8mm - Black & White - 71.25in x 9ft

GRTKTWIN71259BW

Min Buy 1 PC



8mm - Black & White - 71.25in x 11ft

GRTKTWIN712511BW

Min Buy 1 PC



8mm - Black & White - 71.25in x 13ft

GRTKTWIN712513BW

Min Buy 1 PC



8mm - Black & White - 71.25in x 14ft

GRTKTWIN712514BW

Min Buy 1 PC



8mm - Black & White - 71.25in x 15ft

GRTKTWIN-71.2515WBW

Min Buy 1 PC



8mm - Black & White - 71.25in x 20ft

GRTKTWIN712520BW

Min Buy 1 PC



8mm - Clear - 71.25in x 15ft

GRTKTWIN-71.2515

Min Buy 1 PC



8mm - Clear - 71.25in x 16ft

GRTKTWIN-71.2516

UPC 049961977198

Min Buy 1 PC



8mm - Clear - 71.25in x 22ft

GRTKTWIN-71.2522

UPC 049961981423

Min Buy 1 PC



Green.tek



Shade Coverings

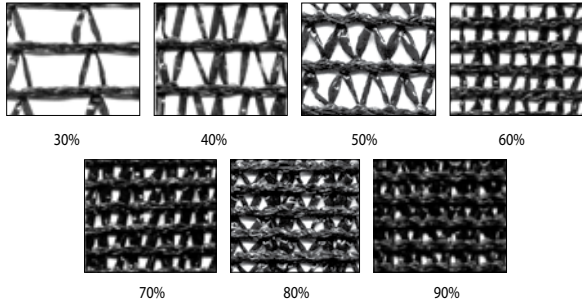

Green-Tek® Shade Rite - Black Shade Cloth

Shade Rite knitted shade cloth from Green-Tek offers open lockstitch design for better ventilation and a reduction in wind speed and heat buildup in structures. Shade Rite is available cut-to-size with no minimums.

- Crop protection for UV and heat sensitive plants
- Better ventilation and water permeable
- Lightweight and easy to install
- U.V. protection: U.V. resistant, high density polyethylene
- Chemical resistant: resists most horticultural chemicals, sprays and detergents
- Tough lockstitch knitted construction. Resists rips, tears and fraying. Shade levels remain constant during product life
- Cost effective: No edge taping and minimal sewing required thanks to knitted lockstitch
- Wide widths available up to 34 feet

Green-Tek® Shade Rite - Knitted Black Shade Cloth

30% Black by the Square Foot

GRTK30% BLACK 
Min Buy 1 SF

40% Black by the Square Foot

GRTK40% BLACK 
Min Buy 1 SF

50% Black - Order by the Square Foot

GRTK50% BLACK 
Min Buy 1 SF

60% Black by the Square Foot

GRTK60% BLACK 
Min Buy 1 SF

70% Black by the Square Foot

GRTK70% BLACK 
Min Buy 1 SF

80% Black by the Square Foot

GRTK80% BLACK 
Min Buy 1 SF

90% Black by the Square Foot

GRTK90% BLACK 
Min Buy 1 SF

Green-Tek® Shade Rite - Knitted Black Shade Cloth Extras

Grommets

Brass Grommets

GRTK29-0064 
Min Buy 1 EA

Plastic Grommets

GRTKPLASTIC GROMMET 
Min Buy 1 EA

Seam Charges

Seaming Charge

GRTKE10300 
Min Buy 1 FT

Taping Charge

GRTKE10320 
Min Buy 1 FT



Green-Tek® Shade Rite - Woven Black Shade Cloth

30% Black by the Square Foot

GRTK30PCTWSBLK 
Min Buy 1 SF

47% Black by the Square Foot

GRTK47PCTWSBLK 
Min Buy 1 SF

55% Black

GRTK55PCTWSBLK 
Min Buy 1 SF

63% Black by the Square Foot

GRTK63PCTWSBLK 
Min Buy 1 SF

73% Black by the Square Foot

GRTK73PCTWSBLK 
Min Buy 1 SF

80% Black by the Square Foot

GRTK80PCTWSBLK 
Min Buy 1 SF

95% Black by the Square Foot

GRTK95PCTWSBLK 
Min Buy 1 SF

Green.tek

Shade Coverings



30% 50% 60% 70%

Green-Tek® Aluminet™ “Cool Shade” Shade Cloth

Aluminet is a high quality reflective metalized HDPE knitted screen used as a greenhouse thermal screen and as an alternative to black shade cloth. It's specially treated to prevent oxidation, and: Protects against frost radiation damages Repels pests and thrips Moderates day/night temperatures Prevents condensation build-up on screens and dripping on plants. Easy to install due to light weight and high elasticity.

30% - Order by the Square Foot

GRTK30% ALUMINET

Min Buy 1 SF



50% by the Square Foot

GRTK50% ALUMINET

Min Buy 1 SF



60% by the Square Foot

GRTK60% ALUMINET

Min Buy 1 SF



70% by the Square Foot

GRTK70% ALUMINET

Min Buy 1 SF



Green-Tek® Aluminum Tape

In addition to a wide range of custom converting solutions, including cut to size, custom taping, and grommet installation, Green-Tek offers a complete range of plastic fasteners and connectors that are suitable for poly, energy curtains, nets, screens and shade cloth. The connectors are easy and quick to install and are designed for different applications. Produced from top quality plastic with UV protection, each type of connector is designed to be used for a specific type of netting and is specific to the manner in which the netting covers the structure.

Green-Tek® Aluminum Foil Tape



1in x 150ft

GRTK26-0823

Min Buy 1 RL



Green-Tek® Aluminum Vent Tape



2in x 150ft

GRTKE03690

Min Buy 1 RL



Shade Coverings

Green-Tek® No-Thrip Insect Screen

The most exclusive screen available, with a hole size of only 150 microns. Tough monofilament construction can be fabricated in any size.



Mesh 75 Sold by the Square Foot

GRTKNO THRIP

Min Buy 1 SF



B&W Film

Green-Tek® Black & White Film

GT Black-White Poly is a highly reflective and opaque 6-mil black-white film that can be used for either bench/ground cover or as a reflective blackout curtain for photoperiod control. GT Black-White Poly is UV-stabilized to ensure durability, and is guaranteed to withstand 12 months or 1 year of UV exposure under normal circumstances. Brilliant white layer ensures maximum light reflectivity to aid in vegetable crop production. 100% film opacity ratings provide maximum control when used as a blackout curtain for your crops. Reflects heat and cools better than shade cloth. Designed specifically to withstand the wear and tear of either foot traffic or retractable curtain systems, so that crop management control is not reduced in these higher-stress applications. High strength at folds means higher resistance to development of punctures and tears. In any film, weaknesses can occur where the polymer strands are bent at a fold. Increased fold strength minimizes performance issues at these key areas.

6mil, 16ft x 100ft

GT4BW616100

Min Buy 1 RL



6mil, 24ft x 100ft

GT4BW624100

Min Buy 1 RL



6mil, 32ft x 100ft

GT4BW632100

Min Buy 1 RL



6mil, 40ft x 100ft

GT4BW640100

Min Buy 1 RL



6mil, 42ft x 100ft

GT4BW642100

Min Buy 1 RL



6mil, 48ft x 100ft

GT4BW648100

Min Buy 1 RL





Shade Coverings

DeWitt® Woven Shade Cloth

DeWitt's® woven polypropylene shade cloth protects plants from direct sun and helps reduce water evaporation.

Polypropylene shade cloth is ideal for greenhouses, outdoor display areas, or for use as a weed barrier for a variety of applications. Available in a wide range of shade percentages, DeWitt's® woven shade cloth resists tearing, puncturing, and weed penetration. UV stabilized to hold up under the most extreme solar conditions.

- **Shade Percentages:** 30%, 47%, 55%, 63%, 73% and 80%
- **Construction:** Sewn, Double-Stitched 100% Black Polypropylene
- **Applications:** Greenhouse, Shade Structure, Nursery, Fish Ponds, Tarpaulin/Product, Containment, Windbreak, Nursery Stock Transport Covers

DeWitt also offers
Knitted Shade Cloth

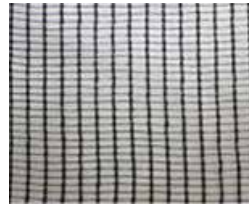

30%



55%



73%



DeWitt shade cloth is available
seamed, taped, and grommetted.

Additional charges
apply for orders
under 1,000sf.

Please check with
your BFG sales rep.

Item #	Description	Standard Widths*	U/M	Barcode
DEWWS30	30% Black	10ft, 12ft	Square foot	
DEWWS47	47% Black	6ft, 10ft, 12ft, 15ft	Square foot	
DEWWS55	55% Black	6ft, 10ft, 12ft, 15ft	Square foot	
DEWWS73	73% Black	4ft, 6ft, 7.5ft, 10ft, 12ft, 15ft	Square foot	
DEWWS80	80% Black	6ft, 10ft, 12ft, 15ft	Square foot	

Ground Cover

DeWitt® Ground Cover

White Ground Cover is a 3.2 oz., UV-stabilized, white woven polypropylene fabric. It is a strong, heavy fabric, which allows it to be more resistant to tearing, puncturing and weed penetration. White Ground Cover can also be used as an alternative to a frost blanket. When applied on top of plantings, it protects against light frost and cold temperatures by holding heat in during the day and by blocking wind at night. White Ground Cover is permeable, allowing water and nutrients to pass through. It is excellent when used in rose growing operations.



Bulk White - 12ft x 300ft

DEWWGC12

UPC 042579813919

Min Buy 1 EA



Bulk White - 3ft x 300ft

DEWWGC3

UPC 042579813896

Min Buy 1 EA



Bulk White - 15ft x 300ft

DEWWGC15

UPC 042579813926

Min Buy 1 EA



Bulk White - 6ft x 300ft

DEWWGC6

UPC 042579813902

Min Buy 1 EA



Coverings Accessories

Grower Select® Spring Lock Spring

Also referred to as wiggle wire, zippers, or zigzag wire. Works with aluminum spring lock base (GSS14498, Sold Separately) to lock single sheet of poly film down on the greenhouse.



6ft 6in - Sold by Bundle of 20

GSE09560

UPC 049961986114

Min Buy 1 BD



Coverings Accessories

Ken-Bar® Inflation Kit

Inflation pressure between layers of double poly adds insulation without blocking sunlight and reduces condensation between the layers of poly. 148cfm.



Single Stack

KB26D02

Min Buy 1 EA

Double Stack

KB26D03

Min Buy 1 EA



Shade Coverings

Mardenkro® ReduSol® Shading Coating

ReduSol has been specifically developed for applications where the coat of whitewash applied to the greenhouse must last for a whole season. It provides an attractive white, even shading coat which can be easily removed using ReduClean at the end of the season. ReduSol is exceptionally resistant to the effects of frost and rain, and is UV stabilized. ReduSol's shading effect can be adjusted according to need. A lighter shading effect can be provided in the spring, for example, than in the summer.



20kg Pail

MARDREDUSOL

Min Buy 1 EA



Mardenkro® ReduHeat® Shading Coating

ReduHeat sets itself apart from other, more traditional shading agents due to its different ratio between light transmission and heat reflection. It is a coating that contains a special pigment which has the ability to transmit growth light (PAR) while increasing the reflection of heat radiation (NIR). Another major advantage of ReduHeat is the adjustable shading effect. It gives you more control over the climate inside your greenhouse. Removeable with ReduClean.



15kg Pail

MARD29-1069

Min Buy 1 EA



ReduSystems® ReduFuse

ReduFuse is a coating that diffuses the light when it enters the greenhouse. Diffused light penetrates deeper into the crop and can improve production and quality.



15kg

MARD REDUFUSE

Min Buy 1 EA



Mardenkro® ReduClean® Shade Remover

ReduClean® removes all Mardenkro® shading coatings from glass, polycarbonate, and plastic film. It must be diluted with clean water before use in a ratio of 1 part ReduClean® to 7 parts water. Add ReduClean® to the water while stirring and Apply ReduClean® evenly to a dry greenhouse surface and allow it to soak in for at least 15 minutes before brushing. Or apply ReduClean when a considerable amount of rain is expected within one week.



20L Pail - HAZARDOUS

MARDREDCLEAN

Min Buy 1 EA



OBSCURA 10070 FR WB+B

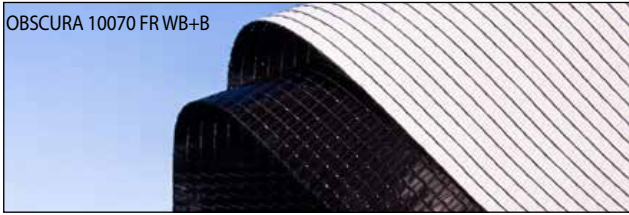

OBSCURA 10075 FB A+BW

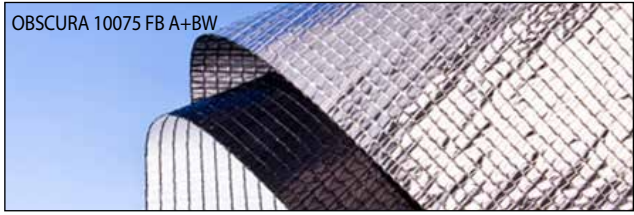

Obscura - Product Family for Light Restriction or Total Balckout

Obscura Screens

The double layered Obscura screen has been giving plants a good night's rest for over 20 years. It does this by providing total blackout from daylight – up to 99.9 percent. And in the last ten years, single layer Obscura has been preventing supplemental lighting from escaping greenhouses at night. This lets neighbors get a good night's sleep and complies with industry legislation.

In both cases, the unique knitted structure provides good moisture managing properties.

Twice as versatile

The double layer also allows more options as the top and bottom of the screen can have different surfaces. Aluminium on the top, for example, provides the greatest energy saving at night, whereas white provides better cooling in sunny weather. White is also useful as a bottom layer for intensifying light inside the greenhouse, whereas black is better for absorbing and restricting interior light.

Where and when you can expect to find Obscura

For short-day plants, such as chrysanthemum, Obscura is ideal for delivering flowers in bloom – on time – for important market dates. Obscura is also popular where supplemental lighting is needed and night time light emission is a problem. This has now proven to be a good investment, as the intensified lighting increases productivity.

- Total control over day length for most sensitive plants.
- Effective cooling when a reflective upper surface is chosen.
- High energy savings, especially if one layer is aluminum.
- Light Emission control that satisfies neighbors and legislation.
- Increased productivity when used with supplemental lighting.
- More uniformity from supplemental lighting in the growing area.
- Good moisture management.

please call
FOR PRICING



LUITEN
GREENHOUSE TECH
SHADING SPECIALISTS
We Put Our Energy Into Saving Yours

Shading systems

We specialize in all kind of shading systems. Utilizing our professional, able and experienced staff to completes each project to the highest standard of satisfaction. Each project must be handled with the highest degree of skill and flexibility during production and installation from start to finish.

1100 Foster Ave. Kalamazoo, MI 49048
arie@luitenshading.com www.luitenshading.com



LUITEN
GREENHOUSE TECH
SHADING SPECIALISTS
We Put Our Energy Into Saving Yours

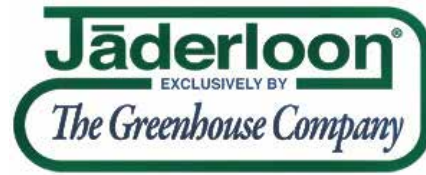

Shade Coverings

Kool Ray® Liquid Shade

Kool Ray is specifically designed to effectively lower the inside greenhouse temperatures during the peak growing season while allowing the growth wavelengths of light to pass through on their way to your plants. Dilution Ratios: KOOL RAY is a super concentrated formula designed to be diluted with water. Standard dilution rate is 1 part KOOL RAY to 8 parts water. Ratios can be adjusted according to the grower's particular needs. Coverage: Coverage will vary according to application, applicator, and dilution ratio. Spray will normally provide the best coverage of approximately 175 square feet per gallon after dilution.



1gal
C09-1316 1G
UPC 751983125333
Min Buy 1 GL

5gal
C09162105
UPC 751983125937
Min Buy 1 5GL

55gal (Special Order)
C09-1316 55G
Min Buy 1 DR



Coverings Accessories

Jaderloon® Inflation Blower Mounting Bracket

Inflation blower bracket with deflector. Blower sold separately.



For 60CFM Blower
JA4PN0030
Min Buy 1 EA



For 148CFM Blowers
JA4PN0035
Min Buy 1 EA

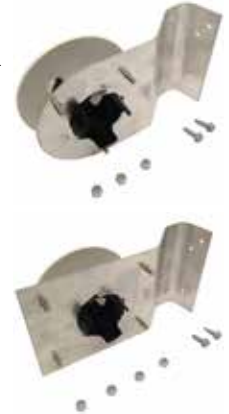

Jaderloon® Jumper Hose

Jumper kits are designed to pass pressure from one section of double poly to an adjoining section. Ideal for inflating sides and endwalls.



36in
JA4PN0024
Min Buy 1 EA



Valley Industrial Product

Coverings Accessories

VIP® Poly Tape - NO Backing

Poly patch tape without backing, used to repair tears in poly film.



2in x 108ft
VIP1460-2X108
Min Buy 1 RL

4in x 108ft
VIP1502X
Min Buy 1 RL

6in x 108ft
VIP1460 6X108
Min Buy 1 RL

VIP® Poly Tape with Backing

Poly patch tape with backing, used to repair tears in poly film.



2in x 48ft
VIP1560L2X48
UPC 049961971059
Min Buy 1 RL

4in x 48ft
VIP1560L4X48
UPC 049961971233
Min Buy 1 RL

6in x 48ft
VIP1560L6X48
UPC 049961971066
Min Buy 1 RL

10in x 48ft
VIP1560L10X48
Min Buy 1 RL



Coverings Accessories

Schaefer® Shade Pole Inflation Blower

Shaded pole inflation blowers have forward curved wheels and energy efficient, open drip proof motors. These blowers are frequently used for inflating air between two layers of greenhouse polyethylene to provide better insulation.



148CFM - For Greenhouses Larger than 30x100

SVEB148

UPC 737623684309

Min Buy 1 EA



60CFM - For Greenhouses Less than 30x100

SVEB60

UPC 737623020602

Min Buy 1 EA



Schaefer® Shade Pole Economy Inflation Blower



148CFM - For Greenhouses Larger than 30x100

SVEB148-E

Min Buy 1 EA



60CFM - For Greenhouses Less than 30x100

SVEB60-E

Min Buy 1 EA



The background of the image shows the interior of a large greenhouse. In the foreground, there are rows of green leafy plants growing in a structured system. The background features a complex metal framework of beams and supports, with a translucent covering that allows light to filter through. The overall scene is bright and organized, representing a modern agricultural facility.

GREENHOUSE *Systems*

Controlled Environment Agriculture and Hydroponics

Controlled-environment agriculture (CEA) is a technology-based approach toward food production utilizing greenhouses structures or a building/grow room to provide protection and maintain optimal growing conditions throughout the development of the crop. Plants are often grown using hydroponic methods in order to supply the proper amounts of water and nutrients to the root zone. CEA optimizes the use of resources such as water, energy, space, capital and labor.

BFG offers a complete line of systems for CEA/Indoor Growing and can help you design and implement an efficient system where you'll have the optimal growing environment for your crop, whatever that maybe.



Rolling Benches
EBB & Flow Benches



Light Deprivation



Irrigation Systems

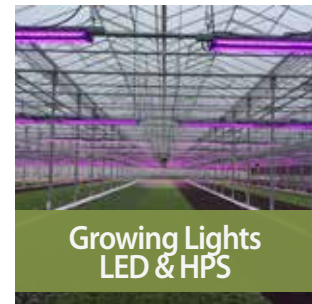

Growing Lights
LED & HPS

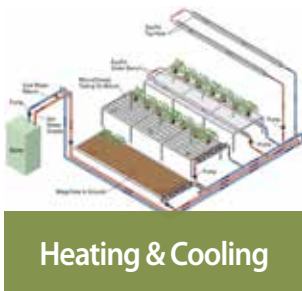

Heating & Cooling

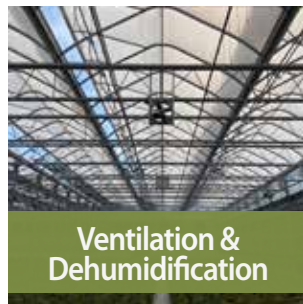

Ventilation &
Dehumidification

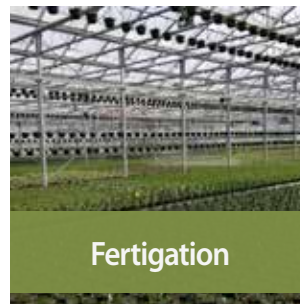

Fertigation



Water Treatment

DeCloet Greenhouses are a great option for CEA. They were originally designed with the purpose of growing vegetable crops hence its heavy-duty design to support hanging systems. Even with the market changes over the last few decades, DeCloet maintained its heavy-duty design making our structures perfect for today's changes and CEA providing protection and maintaining optimal growing conditions throughout the development of the crop.

When we look at lights and lighting, Greenhouses are by far the best way to raise and cultivate crops. Greenhouse structures allow growers and cultivators to harness the power of the sun maximizing the natural lighting combined with supplemental lighting.

Lighting Design:

BFG partnered with LED cutting edge technology companies to provide you the best lighting solution. We can customize systems to optimize production and minimize costs using new technologies, traditional technologies and a hybrid between the two: HPS/LED



HPS



LED

Controlled Environment Agriculture and Hydroponics

BFG experience integrating systems really comes handy when connecting greenhouses with buildings and processing facilities. We can apply proven concepts of horticulture and floriculture to new crops; such as efficient ways to handle soil and soilless media, fertilizers, crop protection and plant care.

We bring decades of proven successful practices that can applied to novelty crops allowing you to be more competitive in constantly changing and evolving markets. Talk to one of our Experts about your Next CEA/Indoor Growing Project!

Lighting Deprivation Systems



Cooling Systems With Integrated Lighting Control



Cooling Systems /Fertigation Systems / Water Treatment Systems

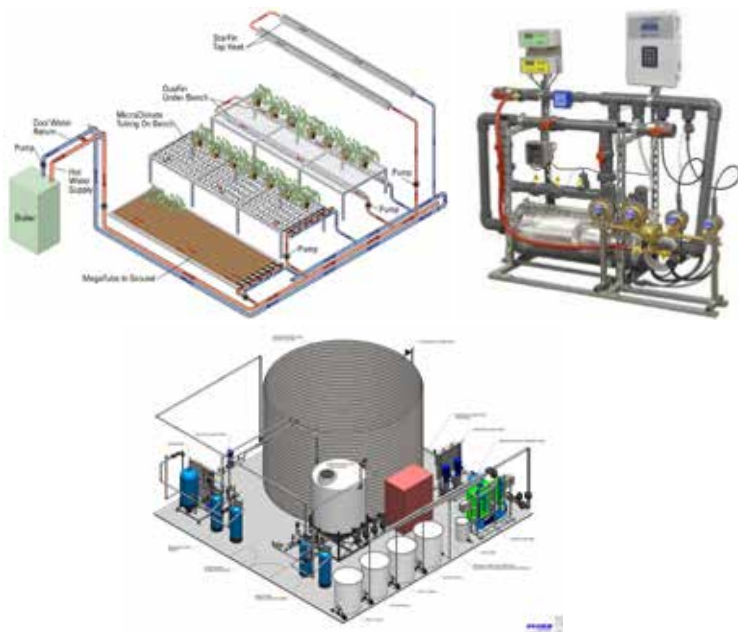

Ventilation Systems



BFG Greenhouse

Construction and Solutions

The BFG Greenhouse Solutions Team assists growers all across the United States with their greenhouse structure needs. Everything from the design, planning, construction and maintenance of new or existing sites, upgrades or remodels, our team is excited and ready to help! We offer a full range of products that include:

- Greenhouse Construction
- Coverings
- Heating & Cooling
- Ventilation
- Climate Control
- Irrigation
- Light Deprivation
- Lighting
- Indoor Grow Rooms

Our experienced team has the technical expertise to guide you through the process and provide the information you need to make the best choice for your operation!



Tap Into Our Resources

Our team is committed to you! Whatever wants or needs you have we are here to help and make the process as seamless as possible. Whether it's a re-cover, improving efficiencies or complete installation, we take pride in providing the resources you need.

Over 4 Decades of Experience

With our team of dedicated professionals, BFG brings decades of experience to each project. Based on our proven success in numerous installation projects we know we can put your mind at ease.

The BFG & DeCloet Advantage

- Highly engineered to reduce installation labor
- Wide bay spacing available in order to maximize production greenhouse efficiency
- Superior gutter design to reduce corrosion and maintenance
- 11 Gauge heavy gutter provides added strength and structural integrity
- Posts, gutters and trusses are galvanized after manufacture for longer rust-free life
- One piece oval bows provide consistency in strength and integrity, available on 4ft and 6ft centers
- Custom designs to meet your special requirements and maximize your footprint
- Available in widths of 18ft, 21ft, 24ft, 32ft, 36ft, 42ft and 48ft
- Single, double, triple span up to 48ft wide



DeCloet Greenhouses are a superior option for CEA. They were originally designed with the purpose of growing vegetable crops, hence its heavy-duty design to support hanging systems. Even with the market changes over the last few decades, DeCloet maintained its heavy-duty design making BFG structures perfect for today's changes and CEA providing protection and maintaining optimal growing conditions throughout the development of the crop.



When looking at lights and lighting, Greenhouses are by far the best way to raise and cultivate crops. Greenhouse structures allow growers and cultivators to harness the power of the sun maximizing the natural lighting combined with supplemental lighting.

From Concept to Completion

Having control of your growing facility makes all the difference. The BFG approach is to begin with your end goal in mind and work together to design and engineer the perfect structure and systems. With a BFG controlled environment greenhouse you'll have the optimal growing environment for your crop, *whatever that maybe*.

Consulting

Before you get started, you should know where to start. BFG provides complete solutions and our services span across all phases of operations - from design to growing/cultivation, and we can assist you plan for future expansion saving valuable time and money.

Systems & Controls Integration

The BFG design philosophy revolves around systems Integration: each grow facility corresponds to a system of systems, each one optimized and integrated to work together. Every element must be in perfect balance for the highest level of control so you can consistently raise high-yield crops.

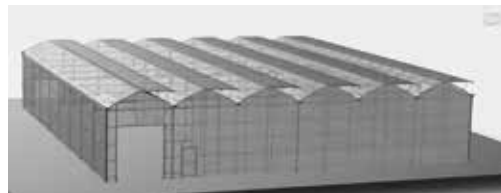

Talk to one of our Experts About Your Next CEA/Indoor Growing Project

Featured project: *Plantpeddler Phase2 Step2 – Cresco, IA*

Structure: Custom DeCloet 8 bays of 43' wide X 216' long double poly roof

Roof vents & vertical vents – providing EXCELLENT natural ventilation

Custom connector to existing building

Growing Facility integrated with Loading Docks

Total Space: 77,000 sf

Pictures below represent – conceptual design, elevation drawing, docks (external and internal) and full rotation of PREMIUM crops: spring, summer/fall crops and poinsettia crop.

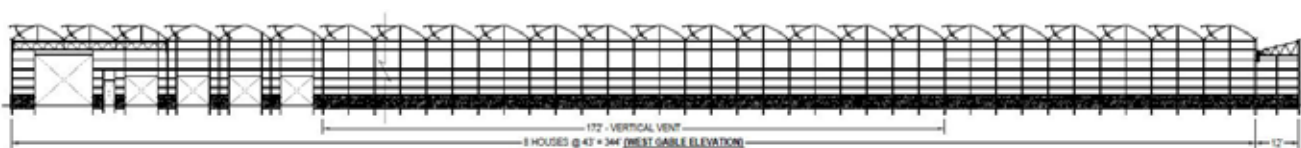

Scan to
watch GHS
Videos!





Scan to watch GHS Videos!

CUSTOMER
Testimonial

Plantpeddler (Cresco, Iowa) "We are a year into our first DeCloet greenhouse structure and have completed the first full rotation of finished crops through the open roof ventilated structures. The quality and consistency of the plants produced in this structure have been spectacular. We have been working with BFG for many years and knew that the combination of the DeCloet structure and the BFG support would not disappoint. From the ease of construction to the terrific communication and support from both BFG and DeCloet, that premonition definitely held true."
Jason Sbiral (Facility Manager)



Production Greenhouse



We know that time is money and we can tailor our services to meet your needs. You can spend your time focused on quality plant growth and we'll focus on building you a quality greenhouse! Our goal is to provide you a piece of mind throughout the design, planning and implementation of your project.

Whether you are looking for professional advice OR complete greenhouse solutions, BFG is at your service. Between our exclusive brands and supplier partners we have the latest structures, equipment and controls to make your production facility efficiently produce outstanding crops. In addition, our team also puts emphasis on streamlining product flow in and out of your facility to help ensure a faster return on investment.

Retail Garden Center



BFG understands the importance when it comes to Retail Greenhouses. It's not just about having the best merchandising, it's about providing a comfortable shopping experience in a setting that is pleasant for your customers and efficient for your staff.

Our team and expertise does not stop once construction is done. BFG supplies Garden Centers nationwide with the latest and most innovative products but we all know it starts with a sound design. That is why we begin each project with the full picture in mind, from curb appeal to product flow to environmental impact. The BFG solutions team will guide you from the design stage to the day you open your doors!

CUSTOMER Testimonials

Meadowridge Inc (Zeeland, MI) – "We have been building DeCloet Greenhouses with BFG for over 20 years, these strong structures are well built and able to withstand the harsh west Michigan winter conditions. DeCloet's greenhouse design has fewer parts than most making it easier and more efficient to build. We really like the 36ft double peak with 2 roof vents per bay, we also have integrated our production and shipping space easily and efficiently using the same greenhouse frame. We look forward to using BFG and DeCloet for our future structure needs."

- Jordan Blauwkamp

Darrell Norris Greenhouse (Racine, OH) – "Looking back, selecting BFG & DeCloet Greenhouses was one of the best decisions we made. The DeCloet Greenhouses are tough and built to withstand our climate. They go together easy and when we are ready to add more square footage their expandability is great. The BFG team is truly the best, from providing the greenhouse design to construction, furnishing the proper greenhouse equipment and last but not least plant grower expertise, BFG has the experts we need. We value our relationship and we see BFG as a partner in the supply chain of horticultural supplies, we work together and succeed together. I would recommend the BFG Greenhouse Solutions team to anyone looking for a greenhouse and horticultural supplies."

- Darrell Norris

Brower Greenhouse (Hudsonville, MI) – "We have been building greenhouses with BFG and DeCloet since 1991, the heavy duty structure from DeCloet combined with the products and services BFG has to offer have been a winning combination for our company. Whether it's construction or supply needs, we truly value our relationship and will continue to do business with DeCloet and BFG Supply in the years to come."

- Kurt Brower

Production Greenhouse

Gutter Connected

DeCloet Gutter Connected Greenhouses are custom designed to meet your needs as well as your crop requirements. Complying with all industry building codes, DeCloet's gutter connected ensures a strong and long lasting growing environment.



- 11 Gauge heavy-duty metal gutters provide added strength to structurally withstand the elements. They are incredibly strong and large enough to walk in, but small enough to minimize shadowing. Posts, gutters and trusses are all galvanized after they've been manufactured to ensure a longer rust-free life.
- One piece oval bows provide consistency in strength, integrity and ease of construction, available on 4ft and 6ft centers
- Highly engineered design for faster and easier assembly and construction
- Exclusive and unique design reduces clutter and maximizes growing space
- Increased light transmission
- Expandability: When you want to expand, you can easily do so without disrupting your existing growing business
- The gutter is designed for expansion and does not require disassembling existing houses
- This is the most economical greenhouse for a large operation
- Custom Sizes Available, including up to 48ft available



Standard Gothic
18ft 21ft 24ft



Twin & Triple Peak Series
28ft 32ft 36ft 42ft 48ft



Max Cool

Max Cool is DeCloet's solution for growers that want to maximize their productivity and efficiencies. The Max Cool is a gutter connected structure.

- Triple Peak 42ft wide frame
- Similar cooling to an open roof structure
- Raised rack and pinion system
- Leading edge of the vent can be raised from the gutter to above the peak
- Maximum cooling
- Proven reliable ridger rack and pinion system
- Easy to cover with 16ft poly tubes
- Up to 35% vent to floor space ratio

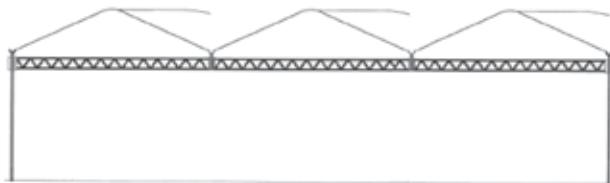

Venlo Glass

DeCloet's world class Venlo Greenhouse combines European design and North American engineering providing a structure with the latest in design for maximum light transmission and a lifetime of successful production. With the tempered glass roof and aluminum glazing system, you get the best value and the least maintenance for your business. It offers our clients a structure capable of withstanding extreme climate conditions with long term protection. The diffused glass option has been a popular option among our latest projects improving the environment climate and increasing production.

The DeCloet Advantage

- Hot dipped galvanized steel structure
- Aluminum roof and sidewall glazing bars
- Clear or diffused tempered glass
- Under gutter height up to 24ft
- Up to 42ft wide triple peak
- Push/Pull vent system



Freestanding

Freestanding Greenhouses, also called Ground to Ground, are suited for professional growers who require unique environments for different crops. They provide the economical growing space and versatility needed. DeCloet's Freestanding and cold frame greenhouses are affordable and versatile structures. With a wide variety of options and sizes available, these greenhouses are practical and easy to assemble.



Freestanding Ground To Ground Options

Sunmaster 24ft 27ft 30ft Widths

Used as both a cold frame and grower house, this series represents our most practical and cost-effective greenhouse. It comes with our exclusive oval tubing for the roof and a full selection of options. Available in 4ft and 5ft bow spacing.



Growers Choice 30ft 35ft Widths

Excellent for both growing and as a retail house. It is stronger than anything else on the market, featuring all welded truss style hoops in the roof, with taller sidewalls. Designed to hold more hanging baskets than any other structure.

Grow Max 30ft 40ft Widths

This webbed truss design offer more benefits and features. Features include more weight support, standard 50lbs snow load on 6ft centers, 7-12ft high straight sidewall above grade. Increased hanging basket capacity.



Cold Frames

These 14ft and 15ft cold frames are designed for overwintering nursery stock or as a temporary growing area. An optional extended stake package is available for extra height. The house can be purchased without stakes and can be made portable by using a baseboard to connect the bows. Most often used with a single purlin with hoop/bow spacing at 4ft O.C. to help eliminate pocketing. (Build your own endwall to complete the structure). Simple design for easy installation. Add-on options include: purlin runs and baseboard clamps.

GrowerSelect®



Cold Frame Bows & Structures

14ft Bow

For Center Height: 6ft 5in Without Stakes - Use 24ft Poly
For Center Height: 8ft 5in with 48in Stakes - Use 28ft Poly

GSA01540 Stocked in Kalamazoo, MI

15ft Bow

For Center Height: 7ft - Use 24ft Poly

GS98-1000A Stocked in Burton, OH

*For a complete Grower Select cold frame quote
Please contact your BFG Representative*

High Tunnels



High tunnels are used to extend the growing season by providing protection for early or late season production, or they may be used for year-round growing. High tunnels are becoming increasingly more popular due to the low start-up cost and quick rate of return on investment. They are a quick and inexpensive way to lengthen your growing season, protect your crop from pests and disease, decrease water usage and increase your crop yield.

Options are available with a roll-up side for optimal ventilation and ease of use. Choose from economical frame-only pricing or standard package pricing to finish your structure. Hoop spacing is available in 4ft or 6ft sections depending on the manufacturer and it can be designed to best fit your use and the needs of your location.



Roof & Side Vents

Ventilation is an essential component for the greenhouse growing environment. Types of ventilation can be forced air or passive ventilation. When designing a new greenhouse, we always take into consideration the passive ventilation incorporating roof & side vents to increase air flow and produce excellent quality crops.

We have the leading-edge technology for gutter vents in the greenhouse industry. We offer raised rack and pinion systems to ensure plenty of room for heat retention systems as well as hinged shaft hangers for easy maintenance in your gutter connect or ground to ground greenhouse.

If your greenhouse does not offer satisfactory ventilation, our team can offer retrofitting options to enhance air flow with your existing structures. Our retrofitting packages are easy to install and will provide significant improvements to your existing structure.



Remodeling & Improvements to Increase Efficiency

Our team has the experience to provide options for your existing structures and ways to help improve your efficiencies. We can assist with improving air flow, improving product flow and the presentation of your greenhouse.

What Are You Looking For?

- Retro fit roof vents for your existing structure
- Rollup or vertical side or end vents
- Recover your gable ends & sidewalls
- Connect your freestanding greenhouses with a header house
- Add loading docks
- Replace old doors

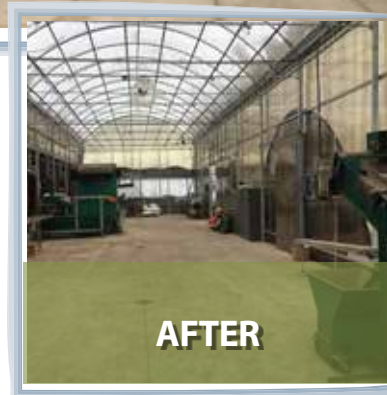

Retail Garden Centers

Garden Centers

Our Retail Garden Center Structures are a combination of beauty and efficiency. The curb appeal alone will make an impression and attract customers but if you combine that with great ventilation and lighting you are sure to create an enjoyable and memorable shopping experience.

Extending beyond the shopping area, we take into consideration the replenishment area making sure that you have an efficient space to stage and replenish inventory. Coverings available include glass, polycarbonate, poly and steel roofing perfect for displays, warehouses, offices, utility rooms and more.



Rimol Matterhorn

The Rimol Matterhorn stands alone as our most attractive Garden Center Structure, rugged and traditionally peaked styled gutter-connected greenhouse. The Matterhorn greenhouse is a high-quality, strong and attractive structure ideally suited for garden centers, growers and schools in any climate in North America. The Matterhorn can withstand heavy snow loads and wind loads, which means you can get a good night's sleep during even the worst winter storms. It offers different glazing options to fit your budget and presentation desires.

The Rimol Matterhorn makes an excellent choice for Garden Centers!

Available in **20ft, 24ft & 30ft widths**

- Lean-to style available in 10ft, 12ft and 15ft widths
- Typical truss spacing on 12ft centers allows for any length in an increment of 12ft
- Super easy to assemble beginning with starter column installation. Four footlong starter column is used for setting the lower section of the column, then the remaining length of column is spliced for an easy installation
- Columns with base plates available
- Columns are 4in x 4in, 13ga galvanized steel
- Non-welded trusses are quality assurance when assembled and allows for easy shipping and assembly
- Trusses consist of 2in, 15ga and 1.5in, 16ga galvanized steel
- Extra purlins near gutter provide additional snow load support in Northern climates. This prevents premature wear on polycarbonate and eliminates leaking
- 6/12 roof pitch
- Large 12ga steel gutter allows easy access to roof and downspouts. They are designed to be located anywhere in the gutter for maximum flexibility
- Can be glazed with 8mm polycarbonate, corrugated polycarbonate, polyethylene film or glass (walls only)



Benching

GrowerSelect®

Grower Select® works with some of the largest and most well-known retailers to provide them with benching that is efficient, flexible and presentable. You can no longer afford to use cement blocks and 2ft x 4ft's to produce a quality product and image. We've produced double deck benching, modular benching and benching with re-supply racks underneath. Our retail benching features complete coverage of the sharp expanded metal ends, corner protectors and plastic caps on all legs and tube ends.

Our production benches feature a 20lb/sqft load capacity and have 3/4in pre-galvanized expanded metal tops. Our special aluminum side rails completely cover all of the sharp expanded metal edges, no more torn pants with our corner protectors! We produce thousands of square feet of rolling benches every year. Our benches can be rolling or stationary, freestanding or cemented. We can usually customize to fit your needs at a very economical price.



*Production
Benching*



Ultra Bench



*Expanded Metal
Bench*

Polytex Shade Systems & Garden Center Packages

Permanent Retail Greenhouses

Seasonal Retail Greenhouses

Commercial Greenhouses

The Garden Mart

Designed to be a modular, low-cost, sales building for added spring plant sales. Our most popular selling model has been engineered for superior strength, easy future expansion and simplified setup. It offers protection for your plants and shopping comfort for your customers.

- Width: 21ft
- Length: 24ft-96ft (in 6ft increments)
- Sidewall height: 6ft
- Height to apex: 11ft 4in
- Frame spacing: 6ft
- Door: 6ft wide x 6ft 8in tall

Sunstopper

The Sunstopper will protect your valuable product from over exposure and windburn, while reducing water requirements. It features straightforward assembly, options for future expansion and is built tough with 2.5in x 12 gauge, galvanized steel for years of trouble free service. The Sunstopper is also offered in custom configurations to meet your existing layout.

20ft x 20ft	40ft x 40ft	60ft x 60ft	100ft x 100ft
20ft x 40ft	40ft x 60ft	60ft x 80ft	200ft x 200ft
20ft x 60ft	40ft x 80ft	60ft x 100ft	

Sun Shadow

The Sun Shadow is designed to be the simple, low-cost shade solution for your seasonal garden center. Protect your plants from the sun and provide a cool, comfortable shopping environment for your customers. The easy-to-assemble, modular design features galvanized steel construction and an extended base plate that allows you to use your palletized product for hold-down.

20ft x 20ft
Custom Sizes Available.

Shade W Truss

The W-Truss is a sturdy shade structure for your plants and customers. Increase customer comfort and reduce the amount of water used and time spent keeping your live product in top-selling shape. Its rugged 3in x 3in vertical posts combine with a strong horizontal truss system to give you one of the best built and most attractive shade structures on the market. It comes standard in 20ft x 20ft blocks with 30%-90% shade cloth and can be customized to fit your exact needs.

20ft x 20ft	40ft x 40ft	60ft x 60ft
20ft x 40ft	40ft x 60ft	60ft x 80ft



Institutional Research & Educational Greenhouses

BFG and its partners design and manufacture education, teaching and research greenhouses. We can help you design your research or education research facility no matter the size. We work with schools around the country and know what is important to the end user: quality, safety and long-lasting performance. We have experience in designing and building state-of-the-art research facilities as well as small greenhouses for a high school program or other educational and developmental programs.

Featured:

Institutional facility in Holland, Michigan
DeCloet Greenhouse Structure
Rimol Matterhorn



Controlled Environment Agriculture and Hydroponics



Bench Growing Systems – EbbFlow | Expanded Metal | Ultra Plastic | Stationary | Rolling



EBB Flow
Benching



Ultra Bench



Production
Benching

Our team has the ability to provide the best greenhouse structure solution for your needs in:

*Aquaponics Hydroponics Aeroponics
Aquaculture Vertical Farming*

Featured project: DeCloet Venlo with diffused glass

Phase 1 completed Summer 2018 – 50,000 sf

Phase 2 completed Fall 2020 – 100,000 sf



Special Purpose Greenhouse

DeCloet Greenhouse Mfg Ltd has supplied many growers with special custom designed and manufactured greenhouse structures to be used for reasons other than growing. These special houses can be used for a variety of purposes, such as, mechanical rooms, head houses, shipping/staging areas and loading docks.

Custom Options

- Wide post spacing up to 48ft
- High side wall heights
- Multitude of roof coverings may include shaded polycarbonate or steel roofing with insulation
- Natural ventilation or exhaust fans
- Large overhead doors
- Loading docks
- Warehouse & Storage Spaces





Greenhouse Structures

DeCloet® Tek Screw

Self-drilling stainless screws.



#14 x 1in Screw

DECLHDF-9190

Min Buy 1 EA

**DeCloet® Swaged Purlin Square**

Square swaged purlin



1.5in x 1.5in x 24ft 4in

DECLPUF-7719

Min Buy 1 EA



2in x 2in x 24ft 4in

DECLPUF-7718

Min Buy 1 EA

DeCloet® Single Stack Inflation Kit

Single stack inflation kit used to inflate a double layer of poly film

**DECLPIF-8550**

Min Buy 1 EA

**DeCloet® 2 Hole Angle Bracket**

2 Hole angle bracket used in greenhouse construction



2in Square

DECLBRF-9711

Min Buy 1 EA

**DeCloet® 4 Hole Angle Bracket**

4 Hole angle bracket used in greenhouse construction



1 1/2in Square

DECLBRF-9712

Min Buy 1 EA



2in Square

DECLBRF-9713

Min Buy 1 EA

DeCloet® Purlin Bracket

Components to be used for greenhouse structures or for benching. Many sizes to choose from to create the layout of your choice.



1.5in

DECLBRF-9708

Min Buy 1 EA

2in Square

DECLBRF-9715

Min Buy 1 EA



Grower Select®

Greenhouse Structures

Grower Select® Carriage Bolt

Components to be used for greenhouse structures or for benching.



5/16in x 2in

BLDF21-2118

Min Buy 1 EA

Grower Select® Baseboard Clamps

Baseboard clamps used to attach a baseboard to a grower select gothic style greenhouse.



1.66in

DLSNB05040

Min Buy 1 EA

Grower Select® Round Clamp Half

Round clamp half used for benching.



1.315in

DLSNB06510

Min Buy 1 EA

**Grower Select® Square Clamp Half**

Square clamp half used for benching.



1in

DLSNMD3000

Min Buy 1 EA



Greenhouse Structures

Grower Select® Aluminum U-Profile 8mm

Used as a perimeter cap on sidewalls and gables and is used in conjunction with our H-profile to provide structure for polycarbonate panels. Fasten to the structures (on sidewalls and gable ends) with wood screws or self-tapping tek screws. When used as a base, weep holes should be drilled every 12in to allow the condensate to drain.



Single Splice - 12ft - 8mm

GSS15102

Min Buy 1 PC



Grower Select® Aluminum H-Profile 8mm

Available in 12ft sections, it is used to splice the panels on sidewalls and gables and is used in conjunction with our U-profile. Fasten to structure with wood screws or self tapping tek screws.



Double Splice - 12ft

GSS13693

UPC 049961204584

Min Buy 1 PC



Grower Select® Cold Frames / High Tunnels

Designed for overwintering nursery stock or as a temporary growing area. An optional extended stake package is available for extra height. The house can be purchased without stakes and can be made portable by using a baseboard to connect the bows. Most often used with a single purlin with hoop/bow spacing at 4ft O.C. to help eliminate pocketing. (Build your own endwall to complete the structure). Simple design for easy installation. Add-on options include: purlin runs and baseboard clamps.



Swaged Purlin - 1/315in x 12ft - 17gauge

GRFSB08670

Min Buy 1 EA



Swaged Purlin - 1.315in x 21ft - 17gauge

GRFSB08680

Min Buy 1 EA

Grower Select® Double Camlock Base

12 foot double cam lock base only. Used for locking multiple sheets of poly film down on the greenhouse. 6 pieces of cam section needed to complete the lock. Usually needed for roll up sides. Sold by the each.



Base Only - 12ft

GSS13697

Min Buy 1 EA

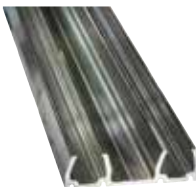

Grower Select® Single Camlock Base

12 foot single cam lock base only. Used for locking multiple sheets of poly film down on the greenhouse. 3 pieces of cam section needed to complete the lock. Sold by the piece. Universal extrusions not only hold roof poly, they also cap off polycarbonate or wood gable ends.



Base Only - 12ft

GSS13698

Min Buy 1 PC



Grower Select® Hex Nut

Components to be used for greenhouse structures or for benching.



.375in

BLDFB05180

Min Buy 1 EA



Grower Select® Permaseal Washer - Neoprene Backed

Components to be used for greenhouse structures or for benching.



1.18in, Usually Used with Polycarbonate

WMNB38-0245

Min Buy 1 EA



Grower Select® Round Galvanized Tubing Support Rails

Components to be used for greenhouse structures or for benching. Many sizes to choose from to create the layout of your choice.



17ga, 1.315in x 144in

GRFSB08640

Min Buy 1 EA



Grower Select® Square Galvanized Tubing

Components to be used for greenhouse structures or for benching. Many sizes to choose from to create the layout of your choice.



16ga, 1in x 288in

GRFSB07750

Min Buy 1 EA

16ga, 1.5in x 288in

GRFS21-0002

Min Buy 1 EA



GrowerSelect®

Greenhouse Structures

Grower Select® Round Machine Head Screw

Components to be used for greenhouse structures or for benching.



.25 x .625in

BLDFB05150

Min Buy 1 EA



Grower Select® Tek screw with Neoprene Washer

Components to be used for greenhouse structures or for benching.



#14 x 1in

WMNBHBT2014016

Min Buy 1 EA



#14 x 1.25in

WMNB38-0236

Min Buy 1 EA

Grower Select® Tek Screw with Zinc Washer

Components to be used for greenhouse structures or for benching.



#12 x 1.5in

BLDF26-1103

Min Buy 1 EA



Grower Select® WoodTite™ Self Tapping Screws

Components to be used for greenhouse structures or for benching.



#10 x 1.5in, Type-17 Point

BLDFB05110

Min Buy 1 EA



#10 x .75in, Type-17 Point

BLDFB05210

Min Buy 1 EA

Grower Select® Self-Tapping Tek Screw

Components to be used for greenhouse structures or for benching.



.75in

BLDF45-1200

Min Buy 1 EA



Benching

AV Plastic Greenhouse Bench Tops

Polypropylene, UV Protected. Durable and lightweight. No sagging when properly supported. Can withstand extremely cold and hot temperatures. Installs on any type of frame with screws or pop rivets. Easy interlocking assembly. Flats, plug trays and pots slide easily over surface, no tipping. Easy to clean and disinfect. Will not rust or decay. Inorganic and will not support the growth of mold and fungus.



18in x 36in x 9/16in

AV18X36

UPC 049961981232

Min Buy 1 EA

24in x 48in x 7/8in

AV24X48

UPC 049961977211

Min Buy 1 EA



SOUTHWEST **AGRI-PLASTICS**, INC.

Benching

Southwest Agri-Plastics Inc Dura-Bench Ultra

The Dura-Bench Ultra is our newest greenhouse bench top. The plastic bench top is tougher, smoother, and is a longer lasting growing surface for your plants. With increased airflow, easier installation and a lower cost per square foot, the latest Dura-Bench Ultra will fit your needs and budget. 2ft x 4ft & 3ft x 4ft (8 or 12sq ft, nominal) high impact abrasion resistant polypropylene plastic panels weigh 4.5lbs each for the 2ft wide and 6.6 lbs for the 3ft wide. 1.1in x 2.1in rectangular holes. Panel ends connect with a four tab and receiving hole system. 4ft sides interconnect with easy to install black nylon clips. Pre-molded screw attachment rails and outer screw attachments tabs for easy installation with stainless steel screws. Dura-Bench Ultra panels allow for any combination of bench sizes. Bench panels can be attached parallel or perpendicular to the length of the bench depending on needs and frame design. 12" and 18" panels can easily be created by cutting between double-ribbed center sections on each size panel. Substructure frame cross supports placed on any incremental interval (such as 16in or 24in centers) based on the weight of the plants per square foot.

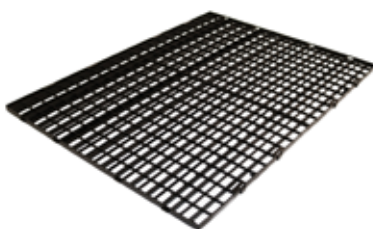

36in x 48in Top
SWAPDBU36X48B Min. Buy 1ea

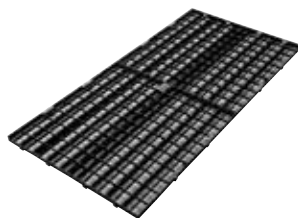

24in x 48in Top
SWAP45-2013 Min. Buy 1ea



Dura-Bench Ultra Clips
SWAP45-2013A Min. Buy 1ea

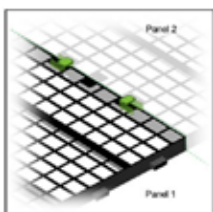

Dura-Bench Ultra Assembly Clip locked in position (in Clip Receivers)

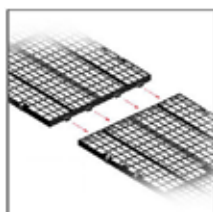

Tabs/Receiver Holes: End-to-End Assembly

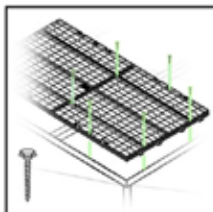

Tek Screw Installed in Screw Attachment Rail (Left: Metal Substructure Stainless Steel Tek Screws. Right: Wood Substructure No. 10 Wood Screws)

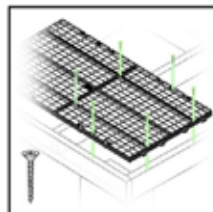

Features:

- 2ft x 4ft & 3ft x 4ft (8sq ft. & 12sq ft., nominal) high impact abrasion resistant polypropylene plastic panel
- 1.1in x 2.1in rectangular holes
- 2ft & 3ft ends connect with a four tab and receiving hole system
- 4ft sides interconnect with easy to install black nylon clips
- Multiple pre-molded screw attachment rails and outer screw attachment tabs for easy installation with stainless steel screws
- Weight 4.5lbs & 6.6 lbs/panel

Table Layout/Design

- Dura-Bench Ultra panels allow for any combination of bench sizes
- Bench panels can be attached parallel or perpendicular to the length of the bench depending on needs and frame design
- 12in and 18in wide panels can easily be created by cutting between double-ribbed center sections on each size panel
- Substructure frame can be made from metal, wood or pipe
- Substructure frame cross supports placed on any incremental interval (such as 16in or 24in centers) based on the weight of the plants per square foot

Southwest Agri-Plastics Inc Dura-Bench Original

The DURA-BENCH Original Overlap design is 2ft wide by 4ft long panel with connections on all four sides. This design utilizes four interlocking tabs along the 4ft side allowing the parts to be adjoined. The 2ft side uses an overlap connection only requiring one cross support.*



Overlap - 24in x 49.5in Top
SWAP45-2011 Min. Buy 1ea





OBSCURA 10070 FR WB+B

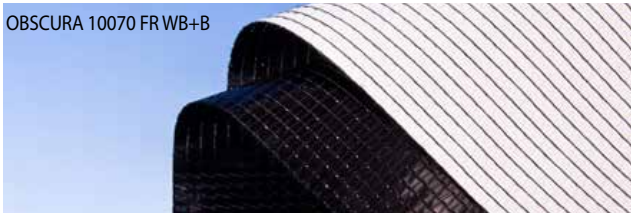

OBSCURA 10075 FB A+BW

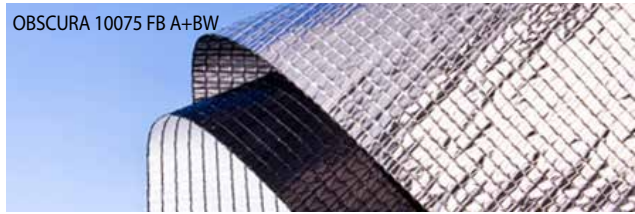

Obscura - Product Family for Light Restriction or Total Blackout

Obscura Screens

The double layered Obscura screen has been giving plants a good night's rest for over 20 years. It does this by providing total blackout from daylight – up to 99.9 percent. And in the last ten years, single layer Obscura has been preventing supplemental lighting from escaping greenhouses at night. This lets neighbors get a good night's sleep and complies with industry legislation.

In both cases, the unique knitted structure provides good moisture managing properties.

Twice as versatile

The double layer also allows more options as the top and bottom of the screen can have different surfaces. Aluminium on the top, for example, provides the greatest energy saving at night, whereas white provides better cooling in sunny weather. White is also useful as a bottom layer for intensifying light inside the greenhouse, whereas black is better for absorbing and restricting interior light.

Where and when you can expect to find Obscura

For short-day plants, such as chrysanthemum, Obscura is ideal for delivering flowers in bloom – on time – for important market dates. Obscura is also popular where supplemental lighting is needed and night time light emission is a problem. This has now proven to be a good investment, as the intensified lighting increases productivity.

- Total control over day length for most sensitive plants.
- Effective cooling when a reflective upper surface is chosen.
- High energy savings, especially if one layer is aluminum.
- Light Emission control that satisfies neighbors and legislation.
- Increased productivity when used with supplemental lighting.
- More uniformity from supplemental lighting in the growing area.
- Good moisture management.

Please Call for Pricing

LUITEN
GREENHOUSE TECH
SHADING SPECIALISTS
We Put Our Energy Into Saving Yours

Shading systems

We specialize in all kind of shading systems. Utilizing our professional, able and experienced staff to completes each project to the highest standard of satisfaction. Each project must be handled with the highest degree of skill and flexibility during production and installation from start to finish.

The background of the page is a top-down view of numerous small, light-colored plastic pots arranged in a grid. Each pot contains a young plant with dark soil and small white perlite granules. The plants have vibrant, multi-colored leaves, with shades of bright green, yellow, orange, and deep red. A large, white diamond shape is superimposed over the center of the image, with a thin white border. The word "INDEX" is printed in a clean, black, sans-serif font within the white diamond.

INDEX

Numbers

13Essentials..... 59

A

Acid Cleaner..... 116
 Acid Mix Fertilizer..... See Fertilizer
Acme Engineering & Mfg...... 222
Actinovate..... 131
 Adaptors..... See Irrigation Components
 Aeration Container..... 141
Agmino Powder..... 54
Agri of Virginia..... 294
 Air Cleaners..... 131
 Alarm..... See Monitoring System
Alaska..... 80
 Algae Extract..... See Fertilizer
 Algaecides..... 116-117, 121, 130
 Organic..... 116-117, 121
 Alkalinity Testing..... 170
 All Purpose Fertilizer..... 40-41, 47, 49, 55, 72, 74, 76, 79, 84
Altus..... 123
 Aluminum Tape..... 267
Amiad Filtration Systems..... 206
 Amino Acid..... 61, 75, 83, 102, 104
Ancora..... 120
 Animal Repellents..... 131
 Ant Control..... 135
 Aphid Control..... 114, 121-123, 126, 129, 132, 134, 136
APTech Group..... 56
Aquatrols..... 117
Arborjet..... 117
Argus Controls..... 252
AT Films..... 264
Attain..... 114
Aurora Innovations..... 24, 60-65, 150, 261
Autopot..... 145
Avid..... 136
AXXE..... 115
Aza-Direct..... 126
AzaGuard..... 115
 Azalea Pots..... 155
Azatin..... 120
Azera..... 127
AZOMITE..... 50
Azos..... 110-111



B

Bacillus..... 68
 Backpack Sprayers..... 218, 230, 236, 248
 Bactericides..... 114-118, 120-126, 128, 130-131, 135
 Copper Octanoate..... 124
 Fogger..... 114
 Organic..... 115-117, 121, 124, 128
 Bags..... 257-259
 Bags Liner..... 259
 Clear No UV Bag..... 259
 Doob Tube..... 259
 Dry Bucket..... 257
 Fresh & Frozen..... 259
 Humidity Control..... 257
 Humidity Indicators..... 258
 Humidity Individual Pack..... 258
 Humidity Packs..... 258
 Preroll Unprinted..... 259
 Realtive Humidity Control..... 257-259
 StripHang..... 257
 SuperSac..... 259
 TerpLoc..... 258
 Ultraclear Pouch..... 258
 UV Pouch..... 258
 Wicket Bag..... 259
Bamboo Supply Company..... 160
 Bark Mix..... See Soil
Bartlett Instrument Co...... 227
Basalt..... 84
 Baseboard Clamps..... 292
BASF..... 66, 114
 Basic Nutrients..... 47-48, 56, 101, 108
 Bat Guano..... 20, 34, 40, 51, 64
Bayer Cropscience..... 123
Beastie Bloomz..... 42
 Bed Bug Control..... 135
Beethoven..... 114
Bellingham..... 247
 Benching..... 292-295
 Benching Components..... 292-295
 Beneficial Nematodes..... 114
Berry bpi Group..... 264
Big Bloom..... 45
Big Foot Mycorrhizae..... 66
BioAdvanced..... 133
Bio-Agricultural..... 67
 Biochar..... See Fertilizer
Biocomposites Group..... 36
 Biodegradable Containers..... 147
 Biodegradable Pots - Propagation..... 32
Bio-Live..... 49
 Biological - Mycoinsecticide..... 123
 Biological - Organic..... 123
 Biological Control Agents..... 114, 122
 Fungus Gnats..... 114, 122
 Thrips..... 114, 122
 Biological Fungicides..... 118, 120, 122, 131
 Biological Insecticide..... 115, 117-118, 120-123, 126, 128, 132
 Biologicals..... 121, 129, 134
Biomin..... 94
BioSafe Systems..... 68, 115-117, 227
BioTherm..... 228
Bio-Turf..... 49

B

Bioworks	121-122
Blacksmith Bioscience	68, 123
Blood Meal.....	51, 76
Bloom Booster.....45, 47, 56-57, 63, 71-72, 77-79, 82-86, 88-89, 91-92, 96, 105, 108	
Blow Molded Container	142-143
Bluelab	166-170
Blumat	207
Bolster.....	99
Bond.....	144, 162, 227
Bone Meal	40, 51, 56, 76, 103-104
Bonide	124
Bonsai Fertilizer	72
Bonsai-Pro.....	72
Bonzi	136
Boomerang.....	43
Bosmere.....	149
BotaniGard.....	121
BRANDT.....	59
Bspec.....	182
Bulletproof Si	57
Bush Doctor.....	42-45

C

Cal Mag Amplified.....	58
Cal-Mag Fertilizer	43, 58, 60, 63, 69
CalOx.....	68
CapSil	117
Captain Jack's Deadbug Brew.....	124
Captiva Prime.....	126
Carry Trays	148, 152, 157
C Round Pots.....	148
Carry Trays - Square Pots.....	148
Carts.....	217, 232
Carts - Display	232
Carts - Transport	232
Caterpillar Control	129
Cavern Culture.....	40
CEASE.....	121
Cedar Ridge Mfg.....	163
Central Coast Garden Products	123, 206
Ceyhinz Link Int.....	33
Cha Ching.....	42
Chapin	230
Chemical Solutions.....	169-172
Calibration	170-172
Cleaning.....	171
Conductivity.....	169
Storage	170-172
Chemical Sprayers.....	216-218, 230, 233, 236
Cherry Creek Systems	239
Citrus Mix.....	49
Cleaners.....	115-116, 125, 130-131, 256, 260-261
Acid.....	116
Foggers.....	125
Granular Algaecide.....	115
Orange Oil	131
Sap Off Soap.....	261
Scissor Scrubber	256
Structures.....	130
Vinegar.....	131
Climate Control Systems.....	249
Clonex.....	93
Cloning Solution	48, 91-92, 101
CO2 Bag.....	101
CO2 Control	101, 109
CO2 Generators.....	236
CO2 Monitor	109
Coast of Maine.....	25
Coco Coir	18-20, 24-25, 31-34
CoExtruded Containers.....	146, 154-155
Cold Foggers	217-218
Cold Frames.....	293
ColorStorm.....	195-196
Compost	81, 99
Conductivity Pens	166-167
Connectivity.....	167
Conserve	125
Containers.....	137-158
Aeration.....	141
Bag.....	146
Biodegradable.....	147
Blow Molded.....	142-143
CoExtruded	146
Fabric.....	138-141, 150
Fiber Blend	138
Flexible.....	146
Injection Molded.....	144
Kit.....	147
Multi Use.....	139-140
Round Pot	142-144
Thermoformed	146
Continental Products	271
Controlled Release Fertilizer	93
Controllers.....	218, 223-226, 233, 236, 240, 249-250
Climate.....	221, 249
Environment.....	168, 249
Irrigation	234-235



C

Ventilation.....227, 249
 Convection Tubing.....232
Corteva..... 125
 Cottonseed Meal..... 51
 Coveralls.....246
 Covering Accessories.....266-267, 269, 271-272
 Inflation Blower.....272
 Insect Screen.....267
 Liquid Shade.....269
 Liquid Shade.....271
 Spring Locks.....269
 Tape.....267, 271
 Coverings.....267
 Ground Film.....267
 Infra Red Film.....264
 Multi Year.....264
 Poly.....265
 Shade.....266-267
 Coverings Accessories.....268, 271
 Ground Cover.....268
 Inflation Blower.....271
 Jumper House.....271
 Crab Meal..... 51
 Crab Shell Fertilizer..... 100-102
Cultivation Nation..... 41-42, 45-46
Curtis Wagner Plastics.....153
Cutting Edge Solutions..... 57-59, 208
Cytoplus.....67



D

DaKine Holdings..... 25, 69-71, 210
Dalen..... 163
 Dechlorinator..... See Solutions
DeCloet Greenhouses.....274-278, 280-283, 289, 291-292
Delta Industries.....222
 Deodorizers.....131
Desiccare Inc.....257-258
Detroit Nutrient Company..... 26
DeVault..... 146, 268
DeWitt..... 146, 268
 Diaphragm Kits.....235
 Diaphragm Pumps.....235
Dicaperl Minerals..... 26
Dilution Solutions..... 196-198
Dirty Dozen..... 42
 Disc Filters..... See Irrigation Components
 Disease Control..... 114-118, 120-126, 128, 130-131, 133-136
 Disinfectants..... 115-116, 130-131
 All Purpose.....115
 Organic..... 115-116
 Display.....86, 108
 Fertilizer.....86, 108
 Display Carts.....232
 Dolomite Lime..... 53
 Dome.....146-147, 150
Don't Bug Me..... 44
Dosatron..... 196-198
 Dosing Cart.....196, 198
 Mixing & Dispensing.....196, 198
Dosmatic.....209
Down to Earth.....49-56
DP Industries.....231
DRAMM..... 125, 190-196, 216-219
 Dribble Tube.....See Drip Irrigation
 Drip Irrigation..... 191, 199-205
 Dribble Tube.....191
 Drip Line.....204-205
 Drippers.....199-200, 202, 204
 Fittings.....201, 203-204
 Line Ends.....201
 Manifolds.....199, 201
 Plugs.....204
 Stakes.....200, 202
 Valves.....201
 Weight Assembly.....202
Dura-Film.....264
Dyna-Gro Nutrition Solutions..... 72-73, 125





E

Eagle.....	125
Earth Juice.....	78-80, 209
EarthBox	147
Earwig Control.....	127
EC Meters.....	168-169, 171
EcoGrow.....	155
Ecological Laboratories.....	74-75, 211
Econo-Grip.....	142
Ectomycorrhizae	95
EndoThrive.....	95
Engineered Essentials.....	162
Enzymes.....	71
Epsom Salt.....	47, 56, 96
Espoma.....	27, 76
Essential Oil Production.....	90
Europic.....	91
Eventherm.....	221
Evergreen	131
Excel	78-80, 209
ExHale.....	101
Exhaust Fans	221
EYE HORTILUX.....	183
Eye Lighting Int.	183

F

Fabric Container	114, 138-140, 150
Fans	219-221, 233, 243
Feather Meal.....	51
Ferrule.....	See Hoses
Fertilizer.....	40-80, 82-89, 91-100, 102-111
Acid Mix	40, 49
Algae.....	91
All Purpose	40-41, 47, 49, 55, 72, 74, 76, 79, 84
Amino Acid.....	61, 75, 83, 102, 104
Biochar.....	82, 88
Bloom.....	45, 47, 56-57, 62-63, 71-72, 77-79, 82-86, 88-89, 91-92, 96, 105, 108
Bonsai.....	72
Calcium.....	54, 56, 58, 71, 79, 86, 89, 102, 105, 108, 110
Cal-Mag.....	43, 58, 60, 63, 69, 97
Dry.....	40-41, 49-54, 64, 65-67, 69, 76, 78, 82-86, 98-100, 105-106, 108, 110-111
Enzymes.....	71
Fish Protein.....	45, 49, 52, 54, 56, 64, 98, 100
Flower.....	41, 50
Foliar.....	66
Foliar Feed.....	43, 59-61, 72, 74-75, 87-89, 98, 103-104
Fruit.....	40, 49-50
Fulvic Acid.....	67
Fungi.....	63, 85
Guano.....	40, 51, 53, 60-61, 64, 102
Humic Acid.....	52, 61, 67, 91
Hydroponic.....	41, 46, 48, 56, 74-75, 87-88, 93
Insect Frass.....	52, 84
Iron.....	44
Iron Chelate	59
Kelp.....	43, 60, 87, 98, 100, 110
Liquid.....	42-46, 54-62, 66-68, 72-75, 77, 79-80, 86-89, 91-92, 95, 98, 100, 102-107, 111
Magnesium.....	44, 58, 72, 87, 96
Meal.....	40, 50-53, 56, 76, 78, 98, 100, 103-105
Microbial.....	44, 106
Micronutrients.....	79
Mineral.....	50, 52-54, 69, 76, 84, 89, 91-92, 98
Molasses.....	79, 104
Mums.....	97
Mycorrhizae.....	49, 76, 78, 82-83, 95, 106, 107, 111
Nitrogen.....	54, 62, 68, 70-72
NPK.....	70
Orchid.....	73
Organic.....	40-41, 43-45, 49-50, 52, 54, 56, 60, 65, 74, 76, 94-96, 98-100, 102, 106-107
Oyster Shell.....	53
Pansy	97
Phosphorus.....	41-42, 46, 53, 62, 64-65, 71, 76, 84-85, 96
Potassium.....	54, 58-59, 79
Root Growth.....	43, 55, 64, 69, 73, 77, 85, 88-89, 93, 110
Silicon.....	57, 73, 88, 91
Soy.....	61
Starter Mix.....	50
Supplement.....	43, 85, 87, 89, 92, 97, 103, 105, 108, 110
Tea Brew.....	111
Topdress.....	64-65
Transplant	41
Vegan Mix	50
Vegetable.....	41-42, 50, 74, 77, 80, 82-83, 99-100
Water Soluble.....	41-42, 47, 54-55, 63, 66, 68-71, 78, 82, 85-86, 95-99, 105-107, 109

F

Fertilizer Accessories.....	73
Fertilizer Injectors.....	217
FERTISS	35
Fiber Blend Container.....	138
Fiber Containers.....	155
FiberGrow	155
Filters.....	206, 212
Injectors.....	245
Fine Americas	126
Fish Meal.....	52
Fish Protein.....	45, 49, 52, 54-56, 64, 80, 98, 100
Fishbone Meal.....	105
Fiskars	260
Flat Line	71
Flats.....	146, 152, 156-157
Flea & Tick Control.....	132
Flea Control.....	135
Flexible Planter.....	146
Flexzilla	208
Floramite	120
Flow Valves.....	See Irrigation Components
Flower Fertilizer.....	See Fertilizer
Flowers Kiss	43
Fluence	177-178
Fly Control.....	129
Foaming Agent Indicator.....	115
Foaming Sprayer.....	218
FOGCO	226
Foggers.....	217-218, 233
Foliage Pro	72
Foliar Feed.....	43, 59-61, 72, 74-75, 87-89, 98, 103-104
Foop Organic Bioscience	77
FossilFuel	91
FoxFarm	40-46
Fruit Fertilizer.....	40, 49-50
Ful-Humix	67
Ful-Power	67
Fulvic Acid Fertilizer.....	67
Fungi Fertilizer.....	63, 85
Fungicides.....	114-115, 117-118, 120-128, 130-133, 135
Citric Acid.....	133
Copper.....	128
Copper Octanoate.....	124
Copper Soap.....	128
Organic.....	115, 117-118, 120-122, 124, 126-128, 131, 133, 135
Ornamentals.....	125
Fungus Gnat Control.....	114, 131



G

Gaia Green	28, 84-89
Garden Kit.....	147
Garden Lime.....	53, 76
GARDENA	213
Gardeneer	163
Gardener Select	160, 210, 261
Gardman	232
GE	184
Gloves.....	246-247
Nitrile Coated.....	247
Disposable.....	246
Rubber Latex.....	246
Gnat Control.....	134
Gold Leaf	56
Good Earth Organics	28
Gowan	126
Grandevo	118
Granular Fertilizer.....	82, 106
Great White	106-107
Green Garden Products	32
GreenClean	115-116
GreenGro Biologicals	82-83, 133, 210
Greenhouse Components.....	292-294
Benching.....	292-295
Brackets.....	292
Camlock Base.....	293
Coverings.....	264
Purlin.....	292
Screws.....	292
Greenhouse Film.....	See Coverings
Greenhouse Structure Cleaners.....	130
Greenhouse Structures.....	292-294
Components.....	292-293
Greensand.....	52, 84
Greenstar Plant Products	28, 84-89
Green-Tek	209, 231, 265-267
Grip-Line	142
Grommets.....	See Irrigation Components
Grotek	85-89
Ground Cover.....	232, 268
White.....	268
Ground Film.....	267
Grove Bags	258-259
Grow Bag.....	See Soil
Grow Big	46
Grow Cubes.....	See Propagation
Grow Light.....	See Lighting
Grow Mats.....	See Propagation
Grow Pro Solutions	90
Grower Select	29, 148-149, 232, 269, 288, 292-294
Grower's Ally	133
GrowFlux	233
Growing Kit.....	147
Growing Media.....	See Soil
Growth Regulator.....	128
Grub Control.....	134
Guano.....	40, 51, 53, 60-61, 64, 102
Bat.....	51, 64
Seabird.....	53, 60-61, 64
Gypsum.....	53-54, 76



H

H.E. Anderson	234-235
HAF Fans	219-220, 231
Handles	192-194
Hanna Instruments	170-171
Happy Frog	40-41
Harvest Hero	26
Harvest More	256
Harvesting	256, 260-261
HDI	29, 91-93
Heaters	241
Heaters - Gas	241
Hemp Fiber	36
Herbicides	115, 134
Organic	115
Weed Preventer	134
High Caliper Growing System	141
High Tunnels	293
Hi-N	99
HLG	181-182
HM Digital	172
Hoffman	28
Hormodin	81
Hort Americas	184
HORTICUBES	35
Horti-Klor	130
Hortonova	161
Hoses	195-196, 208
Connectors	195
Custom	196
Ferrule	195
Swivels	195
Hot Shot	118
Hudson	233
Humic Acid Fertilizer	52, 61, 64, 67, 91
Humidity Dome	146-147, 150
Hyclean	107
Hydraulic Sprayers	216
Hydro Life	212-213
Hydroponic Fertilizer	41, 46, 56, 74-75, 87-88
Hygrozyme	107
Hyshield	136

I

ICL Specialty Fertilizers	93
Ihort	30
Inflation Blower	271-272
Mounting Bracket	271
Shade Pole	272
Inflation Fans	220
Inflation Kit	269
Infra Red Film	264
Injection Molded Containers	144, 154-155, 157
Injectors	197, 209, 217, 235
Accessories	235
Filters	245
Insect Control	44, 114-115, 117-118, 120-136
Insect Frass	52, 84
Insect Growth Regulator	121
Insect Repellent	71
Insect Screen	267
Insect Spray	44
Insect Traps	114, 121
Sticky Cards	121
Insecticidal Soap - Organic	120
Insecticides	44, 114-115, 117-118, 120-128, 130-136
Botanical	131
Cleaner	135
Diatomaceous Earth	132, 135
Fogger	114
Horticultural Oil	128
Neem Oil	124-125, 128, 135
Neem Seeds	125
Organic	115, 117-118, 120, 122-123, 126-128, 131-133, 135
Pyrethrin	124
Spinosad	124
Spray	127, 135
Sticky Traps	134
Strips	118
Water Soluble	117
Diatomaceous	124
Insecticidal Soap	120
Inserts	146, 152, 156
INTEGRA	257-258
Iron	See Fertilizer
Iron Chelate Fertilizers	59, 66, 94
Irrigation Components	197, 199-203, 206, 209, 212
Adaptors	203
Disc Filters	201
Filters	206, 212
Flow Valves	200
Foggers	199
Grommets	200
Hanging Assembly	201
Injectors	197, 209
Misters	201-202
Sprinkler Adaptors	200
Sprinklers	201-203
Irrigation Control	234-235

J

J&D Manufacturing.....	233
J.R. Peters.....	47-48
Jack's.....	47-48
Jack's Classic.....	47
Jack's Professional.....	48
Jacto.....	236
Jaderloon.....	271
Jars.....	257-259
Jet-Ag.....	118
JH Biotech.....	94
Johnson Gas Appliance Company.....	236

K

Kangaroos.....	43
Kase Horticulture.....	237-238
Kelp Fertilizer.....	43, 60, 87, 98, 100, 110
Kelp Me Kelp You.....	43
Kemin Industries.....	132
Ken-Bar.....	269
Kerr.....	257
Kit.....	42, 45, 52, 69-70, 72, 77, 108, 169, 197-198
By-Pass.....	198
Fertilizer.....	42, 45, 69, 70, 72, 77, 108
Filter.....	198
Hook Up Kit.....	197-198
Injection Seal.....	197
Mini Maintenance Kit.....	197
Probe Care.....	169
Seal Kit.....	197
KleenGrow.....	130
Kontos.....	123
Kool Ray.....	271
Kopa.....	120

L

Labels.....	227, 231, 240
LadyBug Control.....	129
Lakos Filtration.....	245
Landmark Plastic.....	146
Langbeinite.....	52, 54
Larvae Control.....	129
Lawn and Garden Products.....	56
Leafminer Control.....	120, 136
Legacy Manufacturing Company.....	208
Lighting.....	175-188
Accessories.....	178
Blue Metal Halide Lamps.....	183
Bulbs.....	179, 184-185
Ceramic HPS Lamps.....	183
Ceramic Metal Halide Lamps.....	179-180, 183
Cords.....	177-178
Fixture.....	177, 179-182, 184, 186
Grow Tent.....	180
HID.....	179-180, 183
HPS Lamps.....	179-180, 183
Kit.....	181, 184-185
LED.....	177-178, 180-182, 184, 186
Propagation.....	184-185
Sockets.....	186
Stands.....	185
Strips.....	184
Systems.....	183
Lime.....	68
Limestone.....	101
Line Ends - Drip Irrigation.....	201
Link4 Corporation.....	249-251
Link-Ups.....	163
Liquid Fertilizer.....	42-46, 54-62, 66-68, 72-75, 77, 79-80, 86-89, 91-93, 95, 98, 100, 102-107, 111
Algae.....	91
All Purpose.....	55, 72, 74, 79
Biochar.....	88
Bloom.....	45, 56, 72, 77, 79, 86-89, 91-92
Bonsai.....	72
Calcium.....	56, 58, 79, 86, 89, 102
Cal-Mag.....	43
Fish Protein.....	56, 80, 98, 100
Humic Acid.....	91
Hydroponic.....	46, 88
Iron.....	44
Kelp.....	87
Magnesium.....	72, 87
Manganese.....	44
Meal.....	56
Microbial.....	44, 106
Micronutrients.....	79
Molasses.....	79, 104
Mycorrhizae.....	106
Orchid.....	73
Phosphorus.....	46
Potassium.....	58-59, 79
Silicon.....	91
Supplement.....	43, 87, 89
Vegetable.....	74, 77, 80
Liquid Shade.....	269, 271
Luiten Greenhouse Tech.....	270, 296
Luster Leaf.....	32, 163, 173-174, 240





M

Mag Amped.....	58
Mag Pro	72
Malibu Compost	32, 81
Mardenkro	269
Marine Cuisine.....	41
Markers.....	227, 240
Marrone Bio Innovations	118
Masks.....	246
Master Plant-Prod.....	96-97
Maxicrop.....	98
Meal	40, 50-53, 56, 76, 78, 98, 100, 103-105
Alfalfa	50
Blood.....	51, 76
Bone.....	40, 51, 56, 76, 103-105
Cottonseed	51
Feather.....	51
Fish	52
Kelp.....	52, 98
Neem Seed.....	52
Shrimp.....	53
Mealybug Control	114, 123, 129
Measuring Cup.....	124
Megaphoton Inc.	179-181, 240
Meters.....	166-172
Conductivity.....	166, 168, 170, 172
EC.....	168-169, 171
Nutrient.....	166-167
pH.....	166, 168-172
Storage	166
TDS.....	170-172
Temperature.....	166, 168, 172
Microbe Brew.....	44
MICROBE Life.....	74-75, 211
Microbe-Lift.....	211
Microbial Inoculant.....	44
Micronutrients	48, 59, 66, 93-94
Micro-Tip.....	260
Midwest Wire Works.....	160
MilStop	121
Mite Control	117, 123, 133
Miticides	114, 117-118, 120, 122-128, 130-136
Fogger.....	114
Neem oil	125
Neem Seeds	125
Organic.....	126-127, 133
Sticky Traps.....	134

M

Modine	241
Moldex	246
Molt-X.....	121
Monitoring System.....	109, 167-168, 250
Monterey	56, 127-128
Mosquito Control	132
MotherPlant.....	92
M-Pede	126
Multi-Year Film Coverings.....	264
Myco Chum	106
MycoApply.....	95
MycoBio	99
Mycorrhizae	18, 22, 31, 49, 63, 66, 76, 78, 82-83, 95, 99, 106-108, 111
Mycorrhizal Applications.....	95, 131
Mycotrol.....	122
Mykos.....	111

N

Nectar for the Gods	31, 102-105
Neem Seed Meal.....	52
NemaShield	122
Nemasys.....	114
Neptunes Harvest.....	100
Netafim Irrigation.....	199-205
Netting	161, 163
Trellis.....	161, 163
NoFly	123
Novelty Manufacturing	147
Nozzles.....	193-194
Nualgi America.....	59
Nursery Containers.....	149, 155
Nursery Supplies.....	142-144

O

OASIS	35
Odor Mitigation.....	242-243, 245
Odorchem Manufacturing.....	242-243
OHP.....	81, 120
Olivia's Solutions.....	101
ONA	242-243
One-Wrap.....	163
Open Sesame.....	42
Orbit Irrigation Products.....	144, 162, 227
Orchid Fertilizer.....	See Fertilizer
Orcon - Organic Control.....	129
Oregon's Only Organics Co.	31, 102-105
Organic Crop Protection.....	95, 115, 117-18, 120-123, 131
Algaecides.....	116
Herbicides	115
Insect Growth Regulators	121
Insecticidal Soap.....	120
Insecticides	115, 118, 120, 126, 131
Mycorrhizae.....	95
Soil Inoculant.....	95
Fungicides.....	121
Organic Fertilizer.....	40-41, 43-45, 49-50, 52, 54, 56, 60, 65, 74, 76, 95-96, 98-99, 100, 102, 106-107
Organic Labs	130
Organic Rescue	145

O

ORGANOCIDE	130
Osmocote	93
OxiDate	115
OxiPhos	115

P

Pace 49	130, 211
Pageant	114
Panacea	162
Peat Pots	147
Perlite	18-22, 26-31, 34
Pest Monitoring	114, 121
Peters	93
pH Adjustment	68
pH Control	46, 53, 76, 96, 103-104, 109
pH Meters	166, 168-169, 171-172
pH Up	See Solutions
Phosphorus Fertilizer	41-42, 46, 53, 62, 64-65, 71, 76, 84-85, 96
Piccolo	126
Pinnacle Climate Technologies	220-221, 272
Plant Amp	58
Plant Caddie	See Plant Dolly
Plant Clips	162
Plant Disinfectants	73, 87, 107
Plant Doctor	130
Plant Dolly	146, 149
Black	146, 149
Hydro Fittings	146
Plant Growth Regulators	126, 136
Plant Perfect	101
Plant Revolution	106-107
Plant Stand	149
Plant Success Organics	106-107
Plant Supplement	See Fertilizer
Plant Supports	159-164
Bamboo	160
Grid	163
Netting	161, 163
Plant Clips	162
Plant Ties	162, 163
Stake	160, 163
Tomato Cage	160, 162-163
Vinyl	160

P

Plant Ties	162-163
Tape	162
Twist	162-163
Wire	163
Plantation Products	32
PlantBest	147, 219
Planter Bag	146
Planters	154-155
Plantex	96-97
Plant-Prod	96-97
Plastic Saucer	144, 149, 153
Plug Trays	148, 150-151
PMP Industries	30
Poly Carbonate	265
Poly Tape	271
Poly-Tex	283
Pot Labels	231, 240
Pot System	145
Potassium Bicarbonate	96
Potassium Sulphate	96
PowerGear	260
Power-Lever	260
PPE	246-247
Premier Tech	108
Priva	251
Production Equipment	253
Pro-Grow Supply Co.	245
ProKure	131, 245
PRO-MIX	108
Propagation ..20, 23, 25, 27, 29-30, 32-33, 35-36, 73, 77, 81, 93, 101, 148-151, 219, 245, 247	
Biodegradable Pots	32
Grow Cubes	30, 33, 35-36
Grow Mats	36
Mat	219, 245, 247
Sheets	148, 151
Pro-TeKt	73
PulsFOG	125, 218
Pump	73
PyGanic	131
Pylon	114
Pyrehum	114



R

R3 Safety	246-247
Radians	247
Rapiclip	163, 240
Rapitest	173-174
ReduClean	269
ReduHeat	269
ReduSol	269
ReduSystems	269
Reefertilizer	108
Regalia	118
Replacement Parts	See Kits
Respirator Mask	246
Rimol	283, 287, 289
Riococo	33
Root Cleaner	123
Root Gel	73
Root Growth Enhancer	43, 55, 64, 69, 73, 77, 81, 85, 88-89, 93, 110
Root Pouch	138-140
Root Riot	29
Rootcubes	35
Roots Organics	24, 60-65, 150
RootShield	122
Rope Ratchet Hangers	240, 247
Round Pot	142-144, 147, 155
Royal Gold	34
Rspec	182
Russet Mite Control	133

S

Safer	135
Sanco Industries	131
SaniDate	115-116
Sanitation Mat	227
Sanitizers	115-116, 130
Hard Surface	116
Organic	115-116
Wipes	116
Sarasota Green Group	133
Saucers	144, 149, 153
Black	153
Clear	144, 149
Deep	144, 153
Heavy Duty	144
Plastic	144, 149, 153
SBM Life Science	133
Schaefer	220-221, 272
Screen-Aire Water Breaker	194
Seabird Guano	40, 53, 60-61, 64
Seed Starter	See Soil
Seeder Trays	148, 150
Self-Watering Kit	145
Sensaphone Inc.	250-251
Sensor	114
Shade Cloths	266-267
Shade Coverings	266-267, 269
Shrimp Meal	53
Shutter Motors	222
Shutters	221
Siebring Mfg. Co.	250-251
Sign Labels	227, 231, 240
Sipco Innovations	107, 136



Sledge Hammer	44
Slug Control	127
Sluggo	127
Smart Pot	141
Smartbee Technology	223-226
Snail Control	127
Soil	18-29, 31-34, 36
Bark Mix	29
Grow Bag	20, 33-34
Organic	18, 22, 24-25, 27
Planting	18, 21-24, 29
Potting	19-23, 25-28, 31-32, 34
Seed Starter	20, 23, 25, 27, 32
Soil Amendments	19, 21, 24-28, 30, 32-33, 36, 46, 52-55, 61, 63-65, 68, 76, 78, 81, 84-85, 99, 103-104
Soil Conditioner	20, 32, 34, 64
Soil Inoculant	68, 95, 99, 108, 121
Soil Test Kit	173-174
Soil Tester	173-174
Solo Motors	248
Solutions	206, 208-211
Dechlorinator	211
pH Down	206, 208-210
pH Up	206, 208-210
Water Conditioner	210
Wetting Agents	211
Soul	61-62, 65
SourDee	58
South Cascade Organics	107
Southwest Agri-Plastics	295
Spacer Trays	157
Spears-T	132

S

Specialty Vermiculite.....	26
Spectrum Brands.....	118
Sphagnum Peat Moss.....	18-23, 29, 31
Spider Mite Control.....	133
Spray Adjuvants.....	117
Spray Misters.....	207
Sprayers.....	216-218, 222, 230, 236, 248, 250
Backpack.....	218, 230, 236, 248
Chemical Application.....	216-217, 230
Foaming.....	218
Hand.....	230, 248
Hydraulic.....	216-217
Mist.....	222
Mosquito.....	230
Multi Purpose.....	222, 230
Orbital.....	222
Pressure.....	222
SprayTrax.....	216
Sprint.....	66
Square Pot.....	152-154, 157
St. Gabriel Organics.....	132
Stake Supports.....	160, 163
Standard Pots.....	156
Round.....	149
Square.....	149
Staples.....	232
Garden.....	232
Stargus.....	118
Storage.....	257-259
STRIP-IT PRO.....	130
SuffOil-X.....	122
Sugaree.....	59
Summit Chemical.....	132
SunBlaster.....	150, 184-185, 247
Super4.....	264
SUPERthrive.....	110
Sustainable Village.....	207
Sustane.....	99
Svensson.....	270, 296
Syngenta.....	136

T

T.O. Plastics.....	151-153
Tags.....	231
TDS Meters.....	171
Tea Brews.....	111
Temperature Meters.....	166, 168, 172
Tenax.....	161
Tents.....	232, 240
Terpify.....	90
TerpLoc.....	258
Terrafibre.....	36
TerraGrow.....	68
The Environmental Factor.....	134
The Greenhouse Company.....	271
The HC Companies.....	154-157
ThermaGlas.....	265
Thermoformed Containers.....	146, 153-155
Thermostat.....	221, 227, 245
Thrips Control.....	114, 121, 125-126, 132-133, 136
Thryve Roots.....	90
Tiger Bloom.....	46
Tilthy Rich.....	71
Timer.....	247
TNB Naturals.....	109, 261
Tomato Cage.....	160, 162-163
Foldable.....	163
Topdress.....	65
Topdress Fertilizer.....	64
TotalGrow.....	186
Transformers.....	236
Transport Carts.....	232
Trays.....	146, 148, 150, 152
Triact 70.....	120
Triathlon BA.....	120
Trimmers.....	256, 260-261
Bag Holder.....	256
Bypass Pruner.....	260-261
Curved Blade.....	261
Extendable Bypass Lopper.....	260
Micro Tip.....	260
Multi Function Scissors.....	261
Precision Curved Blade Pruner.....	261
Pruner.....	261
Pruning Shears.....	260
Pruning Snips.....	260
Replacement Screen.....	256
Scissor Scrubber.....	256
Scissors.....	261
Shears.....	261
Straight Blade.....	261
Trim Bin.....	256
Trim Bin Bottom.....	256
Trim Bin Filter.....	256
Trimming Shears.....	261
Trinity.....	114
Twist II Clean.....	245



U

Uncle Johns Blend.....	59
Unco Industries	36

V

Valley Industrial Product.....	271
Vegetable Fertilizer.....	41-42
Velcro	163
Velifer	114
Venerate.....	118
Ventis Technologies	186
Vented Cultivator.....	101, 109
Ventilation.....	219-220, 222, 227, 231-233, 249
Componants	222
Controller	227, 249
Convection Tubing.....	232
HAF Fans.....	219, 231
Vermiculite.....	18, 22, 26-28, 30, 35
Versa-Kool	220
Vestaron Corporation.....	132
VIP	271
Vitamin Institute	110
VRE Systems	244

W

Wadsworth Control Systems	253
Water Soluble Fertilizer	41-42, 47-48, 54-55, 63, 66, 68-71, 78, 82, 85-86, 93, 95-99, 105-107, 109, 132
Watering Cans	191
Watering Components	192-195
Handles.....	192-194
Nozzles.....	193-194
Shut-Off Valves.....	195
Watering Kit.....	145
Watering Stakes.....	207
Watering Tunnels.....	237
Watering Wands	192, 210
Waukesha Lime & Stone Co.	101
Web Trays.....	156
Weed Barrier	232
Fabric.....	232
Weight Assembly.....	See Drip Irrigation
Wetting Agents.....	See Solutions
White Fly Control.....	114-115, 118, 121, 123, 126, 129, 132
Wholly Mackerel	45
Wiggle Worm	36
World Source Partners LLC.....	232
Worm Castings.....	19, 20, 24, 26, 28, 36

X

Xtreme Gardening	110-111
------------------------	---------

Y

Yara North America.....	108
Yucca Extract.....	44, 103

Z

ZeroTol.....	117
ZYME.....	73



BROWSE BFG SUPPLY'S

vast product assortment
BFG offers more than just CEA/Hydro items!



**TO BROWSE ALL ADDITIONAL
CATEGORIES AND ITEMS AVAILABLE**
please see our full catalog lineup or
visit www.bfgsupply.com today!



Categories

Horticultural Supplies
Lawn & Garden
CEA / Hydroponics
Plants
Seeds

Catalogs

Lawn & Garden
Horticultural Supplies
CEA/Hydroponics
Wetsel Seed Reference Guide
The Plant Connection Spring Trials
Michael Carr Designs
Grower/Gardener Select
Turf & Landscaping Supplies
Greenhouse Structures

Grower

Lawn and
Garden

CEA and
Hydro

Plants and
Seeds



wide variety



Did you know...?

BFG has a mobile app to make ordering easier!

Available for download on the app store and Google play





BFG Supply Co.

Locations

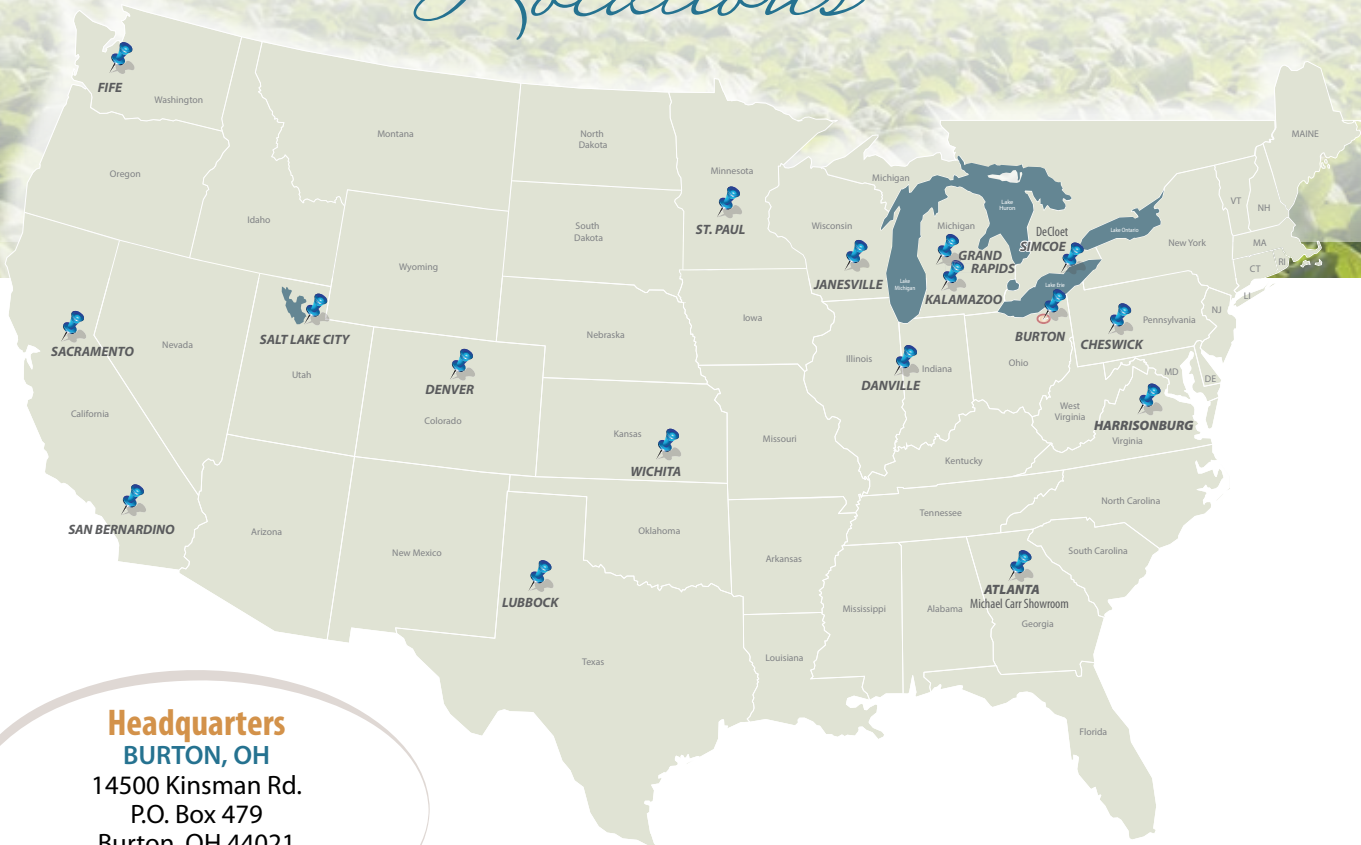

Headquarters

BURTON, OH

14500 Kinsman Rd.
P.O. Box 479
Burton, OH 44021
800-883-0234
FAX: 800-645-6126

CHESWICK, PA

460 Nixon Road, Suite 140
Cheswick, PA 15024
800-821-4351
FAX: 866-551-6929

DENVER, CO

12770 East 39th Ave
Denver, CO 80239
303-371-9790
FAX: 303-371-4729

FIFE, WA

2507 Frank Albert Rd
Ste. C-130
Fife, WA 98424
800-624-2517

GRAND RAPIDS, MI

4660 East Paris Ave., SE
Grand Rapids, MI 49512
800-224-5328
FAX: 616-541-3010

HARRISONBURG, VA

961 N Liberty St.
Harrisonburg, VA 22802
800-572-4018
FAX: 888-434-4894

JANESVILLE, WI

4285 Capital Circle
Janesville, WI 53546
800-269-8816
FAX: 866-393-5441

KALAMAZOO, MI

1144 River St.
Kalamazoo, MI 49048
800-883-7234
FAX: 866-551-6927

LUBBOCK, TX

1400 E. Loop 289
Lubbock, TX 79403
806-744-8894

SALT LAKE CITY, UT

360 North 700 West
Suite J
North Salt Lake City, UT 84054
801-936-0940
FAX: 801-936-0942

SAN BERNARDINO, CA

2552 Shenandoah Way
San Bernardino, CA 92407
1-800-624-2517

ST. PAUL, MN

711 Vandalia Street
St. Paul, MN 55114
800-798-2891
FAX: 866-393-5440

WICHITA, KS

1515 E. 29th St. North
Wichita, KS 67219
316-838-1474
FAX: 316-838-6104

MICHAEL CARR SHOWROOM

3065 Chastain Meadows Pkwy
Bldg 200
Marietta, GA 30066
866-358-9998

DECLOET GREENHOUSES

1805 Charlottesville West Qtr. Line
Simcoe, ON N3Y 4J9
888-786-4769

GREENHOUSE MEGASTORE

70 Eastgate Dr.
Danville, IL 61834
1-888-281-9337
FAX: 1-217-443-0611

GREENHOUSE MEGASTORE

3740 Seaport Blvd, Suite 10
West Sacramento, CA 95691
1-888-281-9337
FAX: 1-916-372-7949



CEA & HYDROPONICS

Catalog 2022



www.bfgsupply.com



14500 Kinsman Road
PO Box 479
Burton, Ohio 44021
(800) 883-0234

Growing Media, Nutrients & Additives,
Insect & Disease Control, Containers,
Plant Supports, Meters & Testers, Lighting,
Irrigation, Equipment, Harvest & Storage,
Coverings and Greenhouse Systems